

CD4020B, CD4024B, CD4040B Types

CMOS Ripple-Carry Binary Counter/Dividers

High-Voltage Types (20-Volt Rating)

CD4020B – 14 Stage

CD4024B – 7 Stage

CD4040B – 12 Stage

■ CD4020B, CD4024B, and CD4040B are ripple-carry binary counters. All counter stages are master-slave flip-flops. The state of a counter advances one count on the negative transition of each input pulse; a high level on the RESET line resets the counter to its all zeros state. Schmitt trigger action on the input-pulse line permits unlimited rise and fall times. All inputs and outputs are buffered.

The CD4020B and CD4040B types are supplied in 16-lead hermetic dual-in-line ceramic packages (F3A suffix), 16-lead dual-in-line plastic packages (E suffix), 16-lead small-outline packages (NSR suffix), and 16-lead thin shrink small-outline packages (PW and PWR suffixes). The CD4040B type also is supplied in 16-lead small-outline packages (M and M96 suffixes).

The CD4024B types are supplied in 14-lead hermetic dual-in-line ceramic packages (F3A suffix), 14-lead dual-in-line plastic packages (E suffix), 14-lead small-outline packages (M, MT, M96, and NSR suffixes), and 14-lead thin shrink small-outline packages (PW and PWR suffixes).

MAXIMUM RATINGS, Absolute-Maximum Values:
DC SUPPLY-VOLTAGE RANGE, (V_{DD})

| | | |
|---|-------|-------------------------------------|
| Voltages referenced to V _{SS} Terminal | | -0.5V to +20V |
| INPUT VOLTAGE RANGE, ALL INPUTS | | -0.5V to V _{DD} +0.5V |
| DC INPUT CURRENT, ANY ONE INPUT | | ±10mA |
| POWER DISSIPATION PER PACKAGE (P _D): | | |
| For T _A = -55°C to +100°C | | 500mW |
| For T _A = +100°C to +125°C | | Derate Linearly at 12mW/°C to 200mW |
| DEVICE DISSIPATION PER OUTPUT TRANSISTOR | | |
| FOR T _A = FULL PACKAGE-TEMPERATURE RANGE (All Package Types) | | 100mW |
| OPERATING-TEMPERATURE RANGE (T _A) | | -55°C to +125°C |
| STORAGE TEMPERATURE RANGE (T _{stg}) | | -65°C to +150°C |
| LEAD TEMPERATURE (DURING SOLDERING): | | |
| At distance 1/16 ± 1/32 inch (1.59 ± 0.79mm) from case for 10s max | | +265°C |

Features:

- Medium-speed operation
- Fully static operation
- Buffered inputs and outputs
- 100% tested for quiescent current at 20 V
- Standardized, symmetrical output characteristics
- Fully static operation
- Common reset
- 5-V, 10-V, and 15-V parametric ratings
- Maximum input current of 1 μA at 18 V over full package-temperature range; 100 nA at 18 V and 25°C
- Noise margin (over full package-temperature range):
 - 1 V at V_{DD} = 5 V
 - 2 V at V_{DD} = 10 V
 - 2.5 V at V_{DD} = 15 V
- Meets all requirements of JEDEC Tentative Standard No. 13B, "Standard Specifications for Description of 'B' Series CMOS Devices"

Applications:

- Control counters
- Timers
- Frequency dividers
- Time-delay circuits

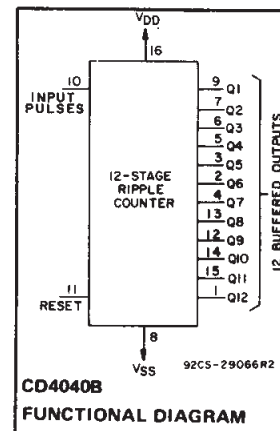
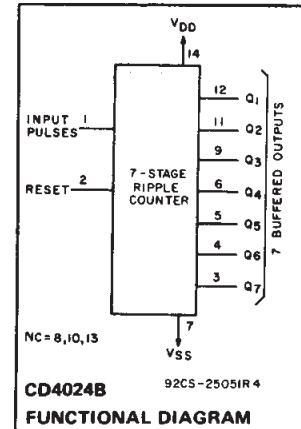
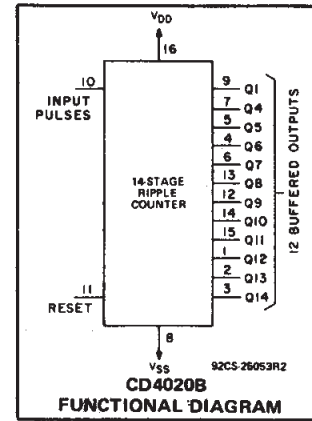

TERMINAL ASSIGNMENTS

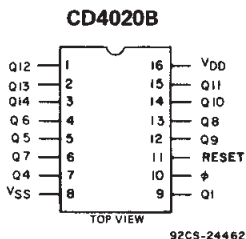

92CS-24462R1

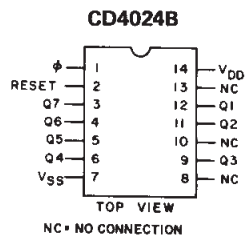

NC = NO CONNECTION

92CS-24466R1

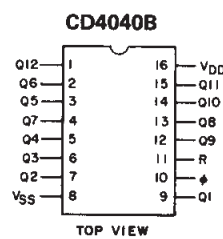

92CS-20747R2

CD4020B, CD4024B, CD4040B Types

RECOMMENDED OPERATING CONDITIONS at $T_A = 25^\circ\text{C}$, Unless Otherwise Specified
 For maximum reliability, nominal operating conditions should be selected so that operation is always within the following ranges:

| CHARACTERISTIC | V_{DD} | Min. | Max. | UNITS |
|--|---------------|-------------------|----------------|---------------|
| Supply Voltage Range (at $T_A = \text{Full Package-Temperature Range}$) | | 3 | 18 | V |
| Input-Pulse Frequency, f_ϕ | 5 10 15 | — | 3.5 8 12 | MHz |
| Input-Pulse Width, t_W | 5 10 15 | 140 60 40 | — — — | ns |
| Input-Pulse Rise or Fall Time, $t_{r\phi}, t_{f\phi}$ | 5 10 15 | Unlimited | | μs |
| Reset Pulse Width, t_W | 5 10 15 | 200 80 60 | — | ns |
| Reset Removal Time, t_{REM} | 5 10 15 | 350 150 100 | — | ns |

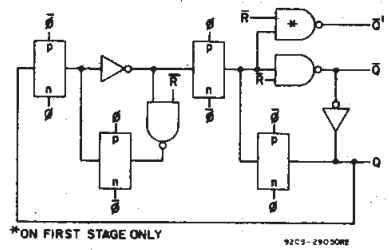

Fig. 4 - Detail of typical flip-flop stage.

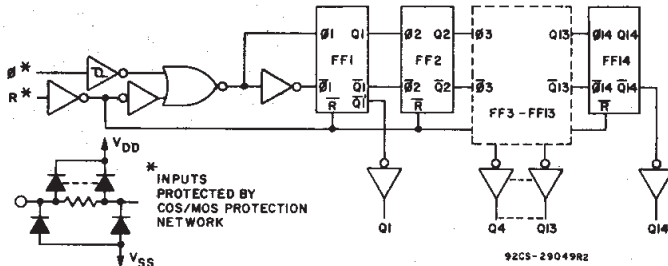

Fig. 1 - Logic diagram for CD4020B.

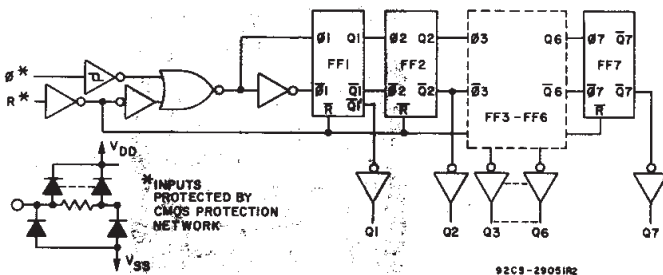

Fig. 2 - Logic diagram for CD4024B.

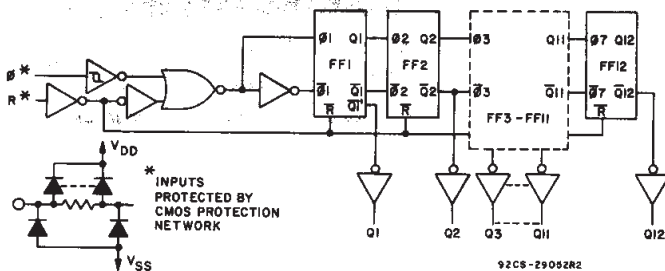

Fig. 3 - Logic diagram for CD4040B.

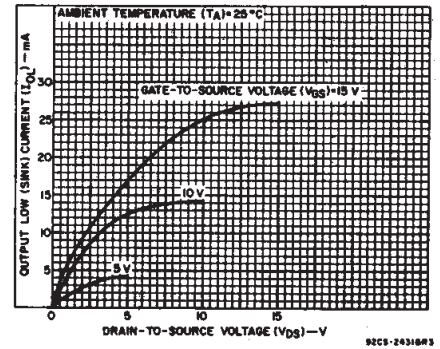

Fig. 5 - Typical output low (sink) current characteristics.

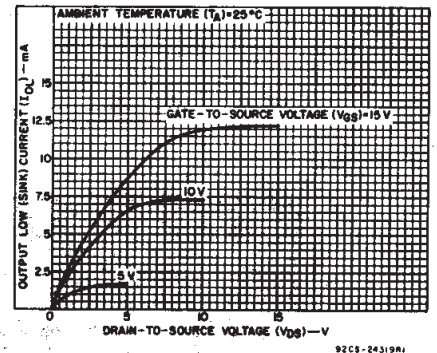

Fig. 6 - Minimum output low (sink) current characteristics.

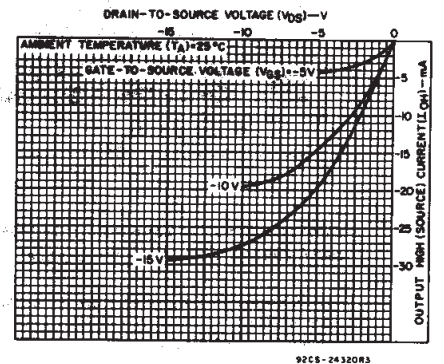

Fig. 7 - Typical output high (source) current characteristics.

3
COMMERCIAL CMOS
HIGH VOLTAGE ICs

CD4020B, CD4024B, CD4040B Types

STATIC ELECTRICAL CHARACTERISTICS

| CHARACTERISTIC | CONDITIONS | | | LIMITS AT INDICATED TEMPERATURES (°C) | | | | | | | UNITS |
|--|--------------------|---------------------|---------------------|---------------------------------------|-------|-------|-------|-------|-------------------|------|-------|
| | V _O (V) | V _{IN} (V) | V _{DD} (V) | -55 | -40 | +85 | +125 | +25 | | | |
| | | | | | | | | Min. | Typ. | Max. | |
| Quiescent Device Current, I _{DD} Max. | - | 0,5 | 5 | 5 | 5 | 150 | 150 | - | 0.04 | 5 | μA |
| | - | 0,10 | 10 | 10 | 10 | 300 | 300 | - | 0.04 | 10 | |
| | - | 0,15 | 15 | 20 | 20 | 600 | 600 | - | 0.04 | 20 | |
| | - | 0,20 | 20 | 100 | 100 | 3000 | 3000 | - | 0.08 | 100 | |
| Output Low (Sink) Current I _{OL} Min. | 0.4 | 0,5 | 5 | 0.64 | 0.61 | 0.42 | 0.36 | 0.51 | 1 | - | mA |
| | 0.5 | 0,10 | 10 | 1.6 | 1.5 | 1.1 | 0.9 | 1.3 | 2.6 | - | |
| | 1.5 | 0,15 | 15 | 4.2 | 4 | 2.8 | 2.4 | 3.4 | 6.8 | - | |
| Output High (Source) Current, I _{OH} Min. | 4.6 | 0,5 | 5 | -0.64 | -0.61 | -0.42 | -0.36 | -0.51 | -1 | - | mA |
| | 2.5 | 0,5 | 5 | -2 | -1.8 | -1.3 | -1.15 | -1.6 | -3.2 | - | |
| | 9.5 | 0,10 | 10 | -1.6 | -1.5 | -1.1 | -0.9 | -1.3 | -2.6 | - | |
| | 13.5 | 0,15 | 15 | -4.2 | -4 | -2.8 | -2.4 | -3.4 | -6.8 | - | |
| Output Voltage: Low-Level, V _{OL} Max. | - | 0,5 | 5 | 0.05 | | | | - | 0 | 0.05 | V |
| | - | 0,10 | 10 | 0.05 | | | | - | 0 | 0.05 | |
| | - | 0,15 | 15 | 0.05 | | | | - | 0 | 0.05 | |
| Output Voltage: High-Level, V _{OH} Min. | - | 0,5 | 5 | 4.95 | | | | 4.95 | 5 | - | V |
| | - | 0,10 | 10 | 9.95 | | | | 9.95 | 10 | - | |
| | - | 0,15 | 15 | 14.95 | | | | 14.95 | 15 | - | |
| Input Low Voltage, V _{IL} Max. | 0.5, 4.5 | - | 5 | 1.5 | | | | - | - | 1.5 | V |
| | 1, 9 | - | 10 | 3 | | | | - | - | 3 | |
| | 1.5, 13.5 | - | 15 | 4 | | | | - | - | 4 | |
| Input High Voltage, V _{IH} Min. | 0.5, 4.5 | - | 5 | 3.5 | | | | 3.5 | - | - | V |
| | 1, 9 | - | 10 | 7 | | | | 7 | - | - | |
| | 1.5, 13.5 | - | 15 | 11 | | | | 11 | - | - | |
| Input Current I _{IN} Max. | - | 0,18 | 18 | ±0.1 | ±0.1 | ±1 | ±1 | - | ±10 ⁻⁵ | ±0.1 | μA |

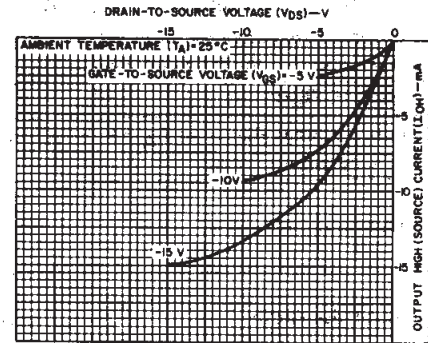

Fig. 8 - Minimum output high (source) current characteristics.

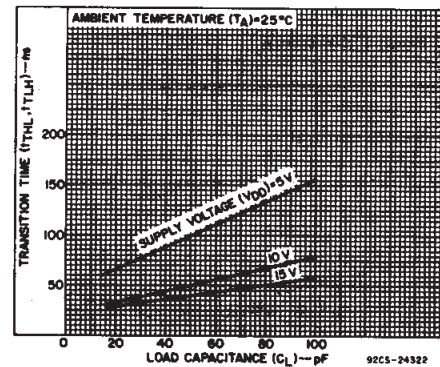
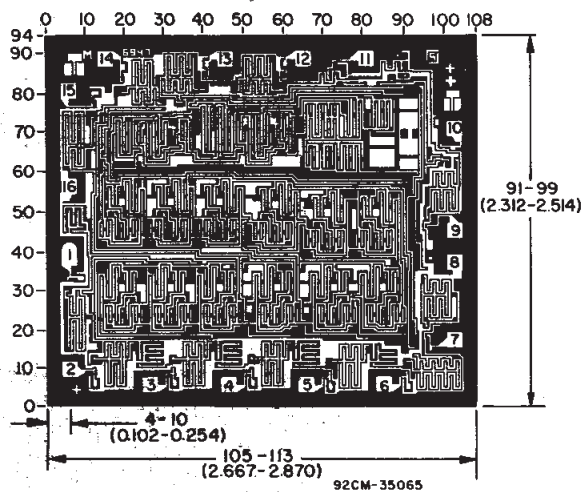
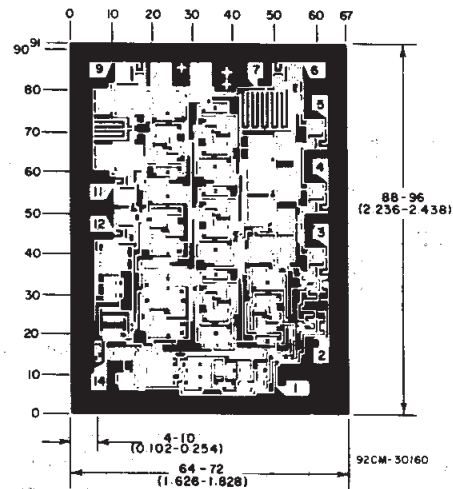

Fig. 9 - Typical transition time as a function of load capacitance.



Dimensions and Pad Layout for CD4020BH. Dimensions and pad layout for CD4040BH are identical.

Dimensions in parentheses are in millimeters and are derived from the basic inch dimensions as indicated. Grid graduations are in mils (10⁻³ inch).



Dimensions and Pad Layout for CD4024BH.

CD4020B, CD4024B, CD4040B Types

DYNAMIC ELECTRICAL CHARACTERISTICS at $T_A = 25^\circ\text{C}$, Input $t_r, t_f = 20 \text{ ns}$,
 $C_L = 50 \text{ pF}$, $R_L = 200 \text{ k}\Omega$

| CHARACTERISTIC | TEST CONDITIONS | V_{DD} (V) | LIMITS | | | UNITS |
|---|-----------------|--------------|-----------|------|------|---------------|
| | | | Min. | Typ. | Max. | |
| Input-Pulse Operation | | | | | | |
| Propagation Delay Time, ϕ to Q_1 Out; t_{PHL}, t_{PLH} | | 5 | — | 180 | 360 | ns |
| | | 10 | — | 80 | 160 | |
| | | 15 | — | 65 | 130 | |
| Q_n to Q_{n+1} ; t_{PHL}, t_{PLH} | | 5 | — | 100 | 330 | ns |
| | | 10 | — | 40 | 80 | |
| | | 15 | — | 30 | 60 | |
| Transition Time, t_{THL}, t_{TLH} | | 5 | — | 100 | 200 | ns |
| | | 10 | — | 50 | 100 | |
| | | 15 | — | 40 | 80 | |
| Minimum Input-Pulse Width, t_W | | 5 | — | 70 | 140 | ns |
| | | 10 | — | 30 | 60 | |
| | | 15 | — | 20 | 40 | |
| Input-Pulse Rise or Fall Time, $t_{r\phi}, t_{f\phi}$ | | 5 | Unlimited | | | μs |
| | | 10 | | | | |
| | | 15 | | | | |
| Maximum Input-Pulse Frequency, f_ϕ | | 5 | 3.5 | 7 | — | MHz |
| | | 10 | 8 | 16 | — | |
| | | 15 | 12 | 24 | — | |
| Input Capacitance, C_i | Any Input | | — | 5 | 7.5 | pF |
| Reset Operation | | | | | | |
| Propagation Delay Time, t_{PHL} | | 5 | — | 140 | 280 | ns |
| | | 10 | — | 60 | 120 | |
| | | 15 | — | 50 | 100 | |
| Minimum Reset Pulse Width, t_W | | 5 | — | 100 | 200 | ns |
| | | 10 | — | 40 | 80 | |
| | | 15 | — | 30 | 60 | |
| Reset Removal Time, t_{REM} | | 5 | — | 175 | 350 | ns |
| | | 10 | — | 75 | 150 | |
| | | 15 | — | 50 | 100 | |

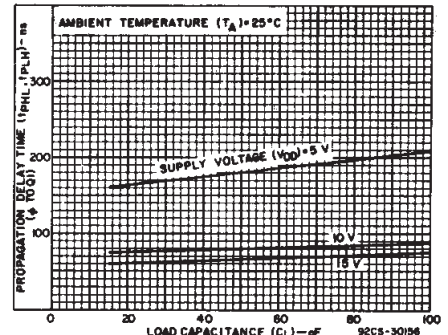

Fig. 10 – Typical propagation delay time as a function of load capacitance (ϕ to Q_1).

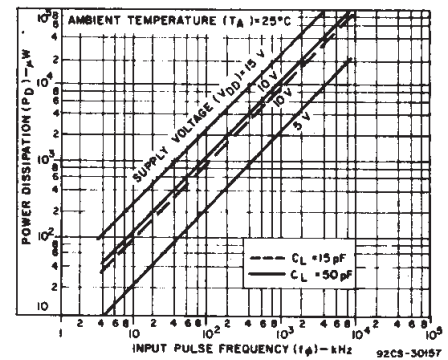

Fig. 11 – Typical dynamic power dissipation as a function of input pulse frequency for CD4020B.

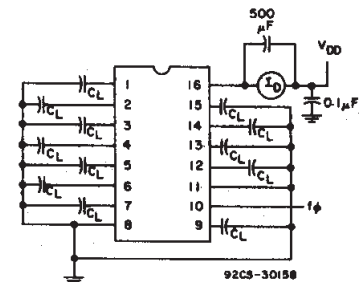

Fig. 12 – Dynamic power dissipation test circuit for CD4020B.

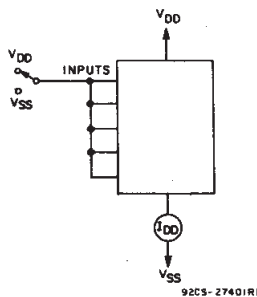

Fig. 13 – Quiescent device current test circuit.

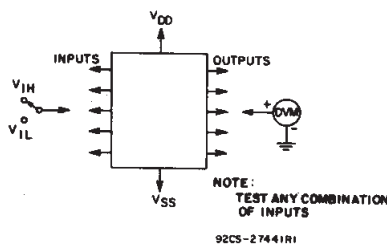

Fig. 14 – Input voltage test circuits.

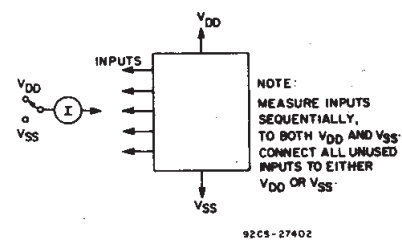

Fig. 15 – Input current test circuit.

3
COMMERCIAL CMOS
HIGH VOLTAGE ICs

PACKAGING INFORMATION

| Orderable Device | Status (1) | Package Type | Package Drawing | Pins | Package Qty | Eco Plan (2) | Lead finish/ Ball material (6) | MSL Peak Temp (3) | Op Temp (°C) | Device Marking (4/5) | Samples |
|------------------|---------------|--------------|-----------------|------|-------------|---------------------|--------------------------------------|----------------------|--------------|-------------------------|-------------------------|
| CD4020BE | ACTIVE | PDIP | N | 16 | 25 | RoHS & Green | NIPDAU | N / A for Pkg Type | -55 to 125 | CD4020BE | Samples |
| CD4020BEE4 | ACTIVE | PDIP | N | 16 | 25 | RoHS & Green | NIPDAU | N / A for Pkg Type | -55 to 125 | CD4020BE | Samples |
| CD4020BF | ACTIVE | CDIP | J | 16 | 1 | Non-RoHS & Green | SNPB | N / A for Pkg Type | -55 to 125 | CD4020BF | Samples |
| CD4020BF3A | ACTIVE | CDIP | J | 16 | 1 | Non-RoHS & Green | SNPB | N / A for Pkg Type | -55 to 125 | CD4020BF3A | Samples |
| CD4020BNSR | ACTIVE | SO | NS | 16 | 2000 | RoHS & Green | NIPDAU | Level-1-260C-UNLIM | -55 to 125 | CD4020B | Samples |
| CD4020BPW | LIFEBUY | TSSOP | PW | 16 | 90 | RoHS & Green | NIPDAU | Level-1-260C-UNLIM | -55 to 125 | CM020B | |
| CD4020BPWR | ACTIVE | TSSOP | PW | 16 | 2000 | RoHS & Green | NIPDAU | Level-1-260C-UNLIM | -55 to 125 | CM020B | Samples |
| CD4024BE | ACTIVE | PDIP | N | 14 | 25 | RoHS & Green | NIPDAU | N / A for Pkg Type | -55 to 125 | CD4024BE | Samples |
| CD4024BEE4 | ACTIVE | PDIP | N | 14 | 25 | RoHS & Green | NIPDAU | N / A for Pkg Type | -55 to 125 | CD4024BE | Samples |
| CD4024BF | ACTIVE | CDIP | J | 14 | 1 | Non-RoHS & Green | SNPB | N / A for Pkg Type | -55 to 125 | CD4024BF | Samples |
| CD4024BF3A | ACTIVE | CDIP | J | 14 | 1 | Non-RoHS & Green | SNPB | N / A for Pkg Type | -55 to 125 | CD4024BF3A | Samples |
| CD4024BM96 | ACTIVE | SOIC | D | 14 | 2500 | RoHS & Green | NIPDAU | Level-1-260C-UNLIM | -55 to 125 | CD4024BM | Samples |
| CD4024BNSR | ACTIVE | SO | NS | 14 | 2000 | RoHS & Green | NIPDAU | Level-1-260C-UNLIM | -55 to 125 | CD4024B | Samples |
| CD4024BPWR | ACTIVE | TSSOP | PW | 14 | 2000 | RoHS & Green | NIPDAU | Level-1-260C-UNLIM | -55 to 125 | CM024B | Samples |
| CD4040BE | ACTIVE | PDIP | N | 16 | 25 | RoHS & Green | NIPDAU | N / A for Pkg Type | -55 to 125 | CD4040BE | Samples |
| CD4040BEE4 | ACTIVE | PDIP | N | 16 | 25 | RoHS & Green | NIPDAU | N / A for Pkg Type | -55 to 125 | CD4040BE | Samples |
| CD4040BF | ACTIVE | CDIP | J | 16 | 1 | Non-RoHS & Green | SNPB | N / A for Pkg Type | -55 to 125 | CD4040BF | Samples |
| CD4040BF3A | ACTIVE | CDIP | J | 16 | 1 | Non-RoHS & Green | SNPB | N / A for Pkg Type | -55 to 125 | CD4040BF3A | Samples |
| CD4040BM | ACTIVE | SOIC | D | 16 | 40 | RoHS & Green | NIPDAU | Level-1-260C-UNLIM | -55 to 125 | CD4040BM | Samples |

| Orderable Device | Status (1) | Package Type | Package Drawing | Pins | Package Qty | Eco Plan (2) | Lead finish/ Ball material (6) | MSL Peak Temp (3) | Op Temp (°C) | Device Marking (4/5) | Samples |
|------------------|---------------|--------------|-----------------|------|-------------|------------------|--------------------------------------|----------------------|--------------|-------------------------|-------------------------|
| CD4040BM96 | ACTIVE | SOIC | D | 16 | 2500 | RoHS & Green | NIPDAU | Level-1-260C-UNLIM | -55 to 125 | CD4040BM | Samples |
| CD4040BNSR | ACTIVE | SO | NS | 16 | 2000 | RoHS & Green | NIPDAU | Level-1-260C-UNLIM | -55 to 125 | CD4040B | Samples |
| CD4040BPWR | ACTIVE | TSSOP | PW | 16 | 2000 | RoHS & Green | NIPDAU | Level-1-260C-UNLIM | -55 to 125 | CM040B | Samples |
| CD4040BPWRG4 | ACTIVE | TSSOP | PW | 16 | 2000 | RoHS & Green | NIPDAU | Level-1-260C-UNLIM | -55 to 125 | CM040B | Samples |
| JM38510/05653BEA | ACTIVE | CDIP | J | 16 | 1 | Non-RoHS & Green | SNPB | N / A for Pkg Type | -55 to 125 | JM38510/ 05653BEA | Samples |
| JM38510/05655BCA | ACTIVE | CDIP | J | 14 | 1 | Non-RoHS & Green | SNPB | N / A for Pkg Type | -55 to 125 | JM38510/ 05655BCA | Samples |
| M38510/05653BEA | ACTIVE | CDIP | J | 16 | 1 | Non-RoHS & Green | SNPB | N / A for Pkg Type | -55 to 125 | JM38510/ 05653BEA | Samples |
| M38510/05655BCA | ACTIVE | CDIP | J | 14 | 1 | Non-RoHS & Green | SNPB | N / A for Pkg Type | -55 to 125 | JM38510/ 05655BCA | Samples |

(1) The marketing status values are defined as follows:

ACTIVE: Product device recommended for new designs.

LIFEBUY: TI has announced that the device will be discontinued, and a lifetime-buy period is in effect.

NRND: Not recommended for new designs. Device is in production to support existing customers, but TI does not recommend using this part in a new design.

PREVIEW: Device has been announced but is not in production. Samples may or may not be available.

OBSOLETE: TI has discontinued the production of the device.

(2) **RoHS:** TI defines "RoHS" to mean semiconductor products that are compliant with the current EU RoHS requirements for all 10 RoHS substances, including the requirement that RoHS substance do not exceed 0.1% by weight in homogeneous materials. Where designed to be soldered at high temperatures, "RoHS" products are suitable for use in specified lead-free processes. TI may reference these types of products as "Pb-Free".

RoHS Exempt: TI defines "RoHS Exempt" to mean products that contain lead but are compliant with EU RoHS pursuant to a specific EU RoHS exemption.

Green: TI defines "Green" to mean the content of Chlorine (Cl) and Bromine (Br) based flame retardants meet JS709B low halogen requirements of <=1000ppm threshold. Antimony trioxide based flame retardants must also meet the <=1000ppm threshold requirement.

(3) MSL, Peak Temp. - The Moisture Sensitivity Level rating according to the JEDEC industry standard classifications, and peak solder temperature.

(4) There may be additional marking, which relates to the logo, the lot trace code information, or the environmental category on the device.

(5) Multiple Device Markings will be inside parentheses. Only one Device Marking contained in parentheses and separated by a "-" will appear on a device. If a line is indented then it is a continuation of the previous line and the two combined represent the entire Device Marking for that device.

⁽⁶⁾ Lead finish/Ball material - Orderable Devices may have multiple material finish options. Finish options are separated by a vertical ruled line. Lead finish/Ball material values may wrap to two lines if the finish value exceeds the maximum column width.

Important Information and Disclaimer:The information provided on this page represents TI's knowledge and belief as of the date that it is provided. TI bases its knowledge and belief on information provided by third parties, and makes no representation or warranty as to the accuracy of such information. Efforts are underway to better integrate information from third parties. TI has taken and continues to take reasonable steps to provide representative and accurate information but may not have conducted destructive testing or chemical analysis on incoming materials and chemicals. TI and TI suppliers consider certain information to be proprietary, and thus CAS numbers and other limited information may not be available for release.

In no event shall TI's liability arising out of such information exceed the total purchase price of the TI part(s) at issue in this document sold by TI to Customer on an annual basis.

OTHER QUALIFIED VERSIONS OF CD4020B, CD4020B-MIL, CD4024B, CD4024B-MIL, CD4040B, CD4040B-MIL :

- Catalog : [CD4020B](#), [CD4024B](#), [CD4040B](#)
- Military : [CD4020B-MIL](#), [CD4024B-MIL](#), [CD4040B-MIL](#)

NOTE: Qualified Version Definitions:

- Catalog - TI's standard catalog product
- Military - QML certified for Military and Defense Applications

TAPE AND REEL INFORMATION



QUADRANT ASSIGNMENTS FOR PIN 1 ORIENTATION IN TAPE



*All dimensions are nominal

| Device | Package Type | Package Drawing | Pins | SPQ | Reel Diameter (mm) | Reel Width W1 (mm) | A0 (mm) | B0 (mm) | K0 (mm) | P1 (mm) | W (mm) | Pin1 Quadrant |
|------------|--------------|-----------------|------|------|--------------------|--------------------|---------|---------|---------|---------|--------|---------------|
| CD4020BNSR | SO | NS | 16 | 2000 | 330.0 | 16.4 | 8.45 | 10.55 | 2.5 | 12.0 | 16.2 | Q1 |
| CD4020BPWR | TSSOP | PW | 16 | 2000 | 330.0 | 12.4 | 6.9 | 5.6 | 1.6 | 8.0 | 12.0 | Q1 |
| CD4024BM96 | SOIC | D | 14 | 2500 | 330.0 | 16.4 | 6.5 | 9.0 | 2.1 | 8.0 | 16.0 | Q1 |
| CD4024BNSR | SO | NS | 14 | 2000 | 330.0 | 16.4 | 8.2 | 10.5 | 2.5 | 12.0 | 16.0 | Q1 |
| CD4024BPWR | TSSOP | PW | 14 | 2000 | 330.0 | 12.4 | 6.9 | 5.6 | 1.6 | 8.0 | 12.0 | Q1 |
| CD4040BM96 | SOIC | D | 16 | 2500 | 330.0 | 16.4 | 6.5 | 10.3 | 2.1 | 8.0 | 16.0 | Q1 |
| CD4040BNSR | SO | NS | 16 | 2000 | 330.0 | 16.4 | 8.1 | 10.4 | 2.5 | 12.0 | 16.0 | Q1 |
| CD4040BPWR | TSSOP | PW | 16 | 2000 | 330.0 | 12.4 | 6.9 | 5.6 | 1.6 | 8.0 | 12.0 | Q1 |

TAPE AND REEL BOX DIMENSIONS

*All dimensions are nominal

| Device | Package Type | Package Drawing | Pins | SPQ | Length (mm) | Width (mm) | Height (mm) |
|------------|--------------|-----------------|------|------|-------------|------------|-------------|
| CD4020BNSR | SO | NS | 16 | 2000 | 356.0 | 356.0 | 35.0 |
| CD4020BPWR | TSSOP | PW | 16 | 2000 | 356.0 | 356.0 | 35.0 |
| CD4024BM96 | SOIC | D | 14 | 2500 | 356.0 | 356.0 | 35.0 |
| CD4024BNSR | SO | NS | 14 | 2000 | 356.0 | 356.0 | 35.0 |
| CD4024BPWR | TSSOP | PW | 14 | 2000 | 356.0 | 356.0 | 35.0 |
| CD4040BM96 | SOIC | D | 16 | 2500 | 340.5 | 336.1 | 32.0 |
| CD4040BNSR | SO | NS | 16 | 2000 | 356.0 | 356.0 | 35.0 |
| CD4040BPWR | TSSOP | PW | 16 | 2000 | 356.0 | 356.0 | 35.0 |

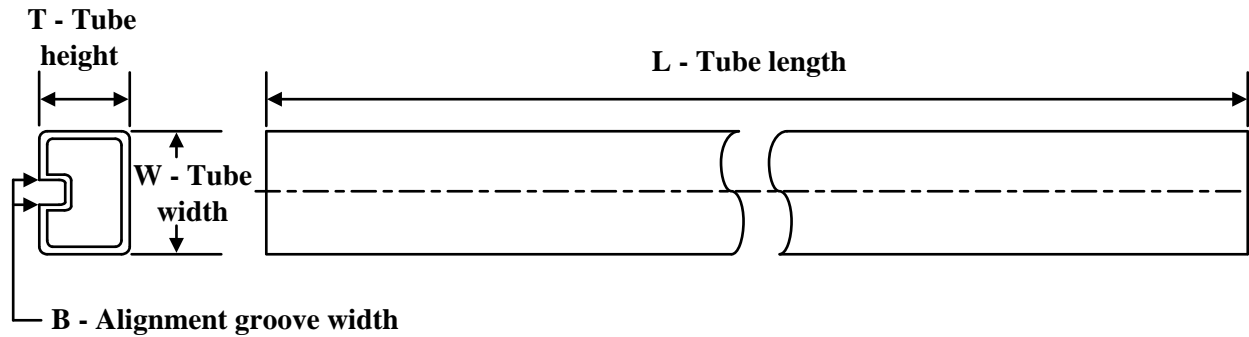
TUBE

*All dimensions are nominal

| Device | Package Name | Package Type | Pins | SPQ | L (mm) | W (mm) | T (μm) | B (mm) |
|------------|--------------|--------------|------|-----|--------|--------|--------|--------|
| CD4020BE | N | PDIP | 16 | 25 | 506 | 13.97 | 11230 | 4.32 |
| CD4020BE | N | PDIP | 16 | 25 | 506 | 13.97 | 11230 | 4.32 |
| CD4020BEE4 | N | PDIP | 16 | 25 | 506 | 13.97 | 11230 | 4.32 |
| CD4020BEE4 | N | PDIP | 16 | 25 | 506 | 13.97 | 11230 | 4.32 |
| CD4020BPW | PW | TSSOP | 16 | 90 | 530 | 10.2 | 3600 | 3.5 |
| CD4024BE | N | PDIP | 14 | 25 | 506 | 13.97 | 11230 | 4.32 |
| CD4024BE | N | PDIP | 14 | 25 | 506 | 13.97 | 11230 | 4.32 |
| CD4024BEE4 | N | PDIP | 14 | 25 | 506 | 13.97 | 11230 | 4.32 |
| CD4024BEE4 | N | PDIP | 14 | 25 | 506 | 13.97 | 11230 | 4.32 |
| CD4040BE | N | PDIP | 16 | 25 | 506 | 13.97 | 11230 | 4.32 |
| CD4040BE | N | PDIP | 16 | 25 | 506 | 13.97 | 11230 | 4.32 |
| CD4040BEE4 | N | PDIP | 16 | 25 | 506 | 13.97 | 11230 | 4.32 |
| CD4040BEE4 | N | PDIP | 16 | 25 | 506 | 13.97 | 11230 | 4.32 |
| CD4040BM | D | SOIC | 16 | 40 | 507 | 8 | 3940 | 4.32 |



PACKAGE OUTLINE

NS0016A

SOP - 2.00 mm max height

SOP

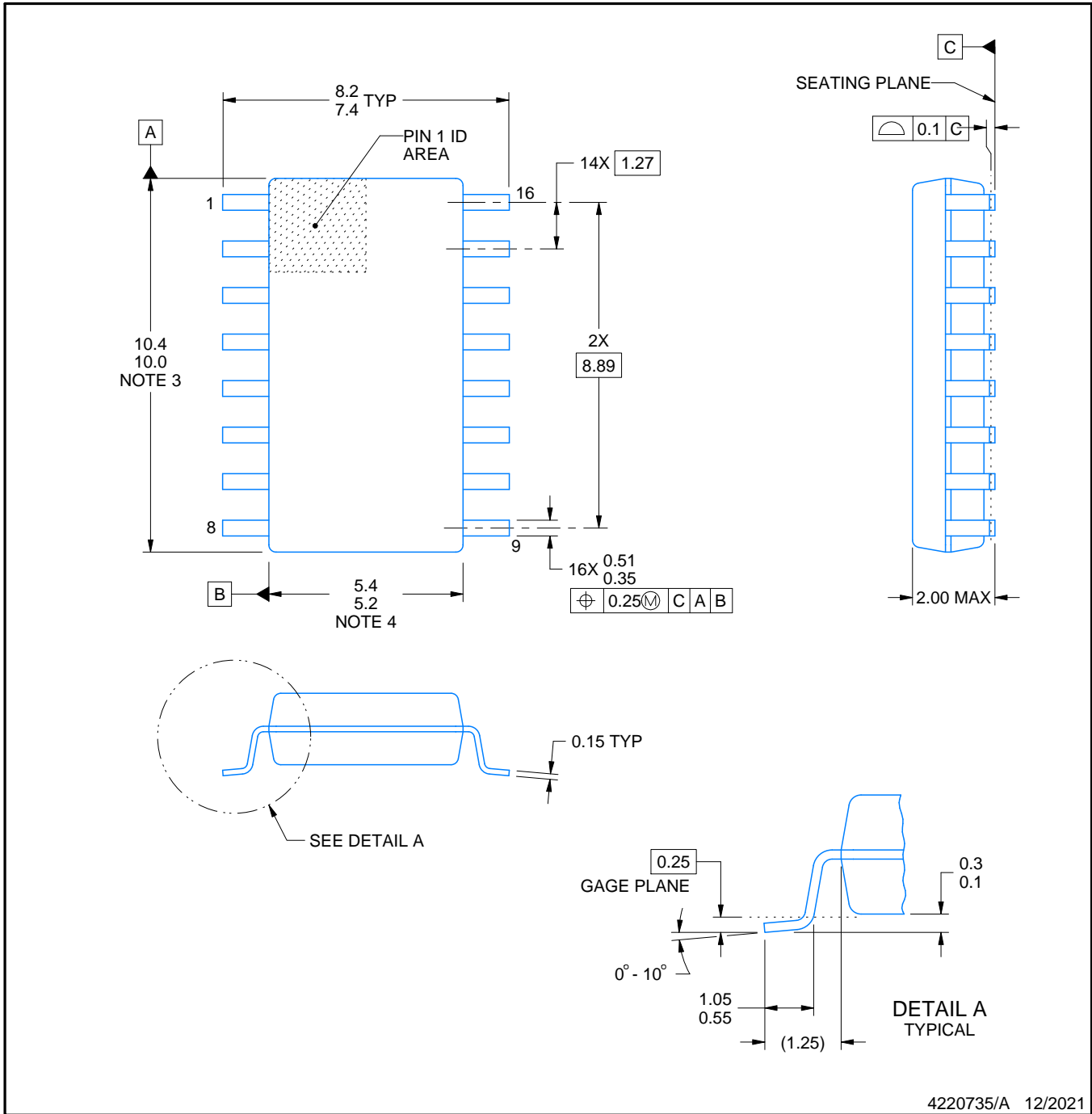

4220735/A 12/2021

NOTES:

1. All linear dimensions are in millimeters. Dimensions in parenthesis are for reference only. Dimensioning and tolerancing per ASME Y14.5M.
2. This drawing is subject to change without notice.
3. This dimension does not include mold flash, protrusions, or gate burrs. Mold flash, protrusions, or gate burrs shall not exceed 0.15 mm, per side.
4. This dimension does not include interlead flash. Interlead flash shall not exceed 0.25 mm, per side.

EXAMPLE BOARD LAYOUT

NS0016A

SOP - 2.00 mm max height

SOP



4220735/A 12/2021

NOTES: (continued)

5. Publication IPC-7351 may have alternate designs.

6. Solder mask tolerances between and around signal pads can vary based on board fabrication site.

EXAMPLE STENCIL DESIGN

NS0016A

SOP - 2.00 mm max height

SOP

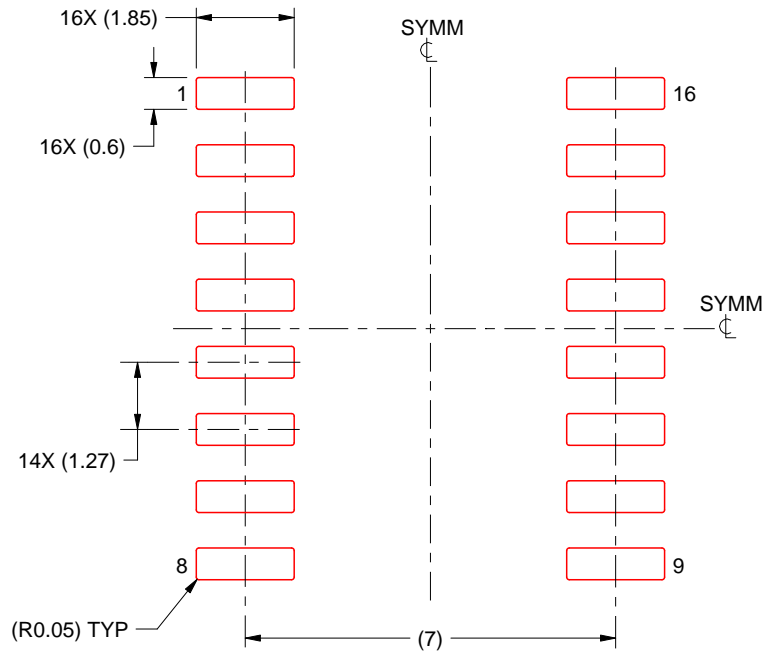

SOLDER PASTE EXAMPLE
BASED ON 0.125 mm THICK STENCIL
SCALE:7X

4220735/A 12/2021

NOTES: (continued)

7. Laser cutting apertures with trapezoidal walls and rounded corners may offer better paste release. IPC-7525 may have alternate design recommendations.
8. Board assembly site may have different recommendations for stencil design.

D (R-PDSO-G16)

PLASTIC SMALL OUTLINE



- NOTES:
- A. All linear dimensions are in inches (millimeters).
 - B. This drawing is subject to change without notice.
 - C. Body length does not include mold flash, protrusions, or gate burrs. Mold flash, protrusions, or gate burrs shall not exceed 0.006 (0,15) each side.
 - D. Body width does not include interlead flash. Interlead flash shall not exceed 0.017 (0,43) each side.
 - E. Reference JEDEC MS-012 variation AC.

D (R-PDSO-G16)

PLASTIC SMALL OUTLINE



- NOTES:
- All linear dimensions are in millimeters.
 - This drawing is subject to change without notice.
 - Publication IPC-7351 is recommended for alternate designs.
 - Laser cutting apertures with trapezoidal walls and also rounding corners will offer better paste release. Customers should contact their board assembly site for stencil design recommendations. Refer to IPC-7525 for other stencil recommendations.
 - Customers should contact their board fabrication site for solder mask tolerances between and around signal pads.



4220204/A 02/2017

NOTES:

1. All linear dimensions are in millimeters. Any dimensions in parenthesis are for reference only. Dimensioning and tolerancing per ASME Y14.5M.
2. This drawing is subject to change without notice.
3. This dimension does not include mold flash, protrusions, or gate burrs. Mold flash, protrusions, or gate burrs shall not exceed 0.15 mm per side.
4. This dimension does not include interlead flash. Interlead flash shall not exceed 0.25 mm per side.
5. Reference JEDEC registration MO-153.

EXAMPLE BOARD LAYOUT

PW0016A

TSSOP - 1.2 mm max height

SMALL OUTLINE PACKAGE



LAND PATTERN EXAMPLE
EXPOSED METAL SHOWN
SCALE: 10X

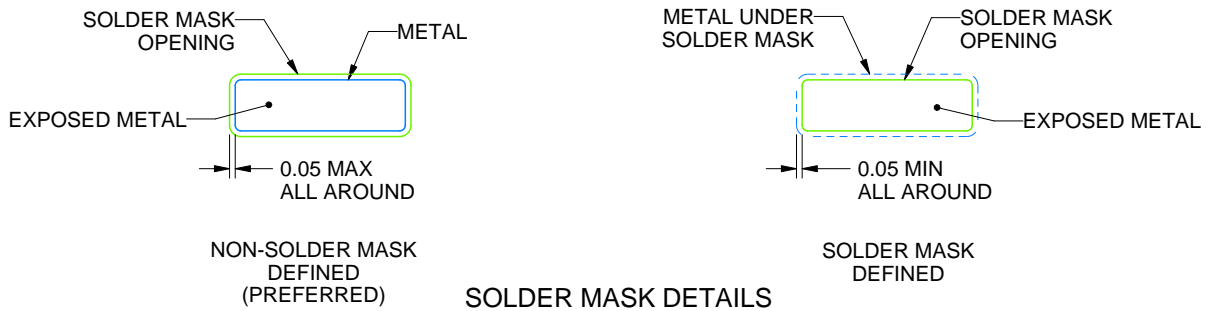

4220204/A 02/2017

NOTES: (continued)

- 6. Publication IPC-7351 may have alternate designs.
- 7. Solder mask tolerances between and around signal pads can vary based on board fabrication site.

EXAMPLE STENCIL DESIGN

PW0016A

TSSOP - 1.2 mm max height

SMALL OUTLINE PACKAGE



SOLDER PASTE EXAMPLE
BASED ON 0.125 mm THICK STENCIL
SCALE: 10X

4220204/A 02/2017

NOTES: (continued)

8. Laser cutting apertures with trapezoidal walls and rounded corners may offer better paste release. IPC-7525 may have alternate design recommendations.
9. Board assembly site may have different recommendations for stencil design.

MECHANICAL DATA

NS (R-PDSO-G**)

PLASTIC SMALL-OUTLINE PACKAGE

14-PINS SHOWN



- NOTES:
- A. All linear dimensions are in millimeters.
 - B. This drawing is subject to change without notice.
 - C. Body dimensions do not include mold flash or protrusion, not to exceed 0,15.

J (R-GDIP-T**)

14 LEADS SHOWN

CERAMIC DUAL IN-LINE PACKAGE



| DIM \ PINS ** | 14 | 16 | 18 | 20 |
|---------------|------------------------|------------------------|------------------------|------------------------|
| A | 0.300 (7,62) BSC | 0.300 (7,62) BSC | 0.300 (7,62) BSC | 0.300 (7,62) BSC |
| B MAX | 0.785 (19,94) | .840 (21,34) | 0.960 (24,38) | 1.060 (26,92) |
| B MIN | — | — | — | — |
| C MAX | 0.300 (7,62) | 0.300 (7,62) | 0.310 (7,87) | 0.300 (7,62) |
| C MIN | 0.245 (6,22) | 0.245 (6,22) | 0.220 (5,59) | 0.245 (6,22) |



4040083/F 03/03

- NOTES:
- A. All linear dimensions are in inches (millimeters).
 - B. This drawing is subject to change without notice.
 - C. This package is hermetically sealed with a ceramic lid using glass frit.
 - D. Index point is provided on cap for terminal identification only on press ceramic glass frit seal only.
 - E. Falls within MIL STD 1835 GDIP1-T14, GDIP1-T16, GDIP1-T18 and GDIP1-T20.

J 14

GENERIC PACKAGE VIEW
CDIP - 5.08 mm max height
CERAMIC DUAL IN LINE PACKAGE



Images above are just a representation of the package family, actual package may vary.
Refer to the product data sheet for package details.

4040083-5/G

J0014A



PACKAGE OUTLINE

CDIP - 5.08 mm max height

CERAMIC DUAL IN LINE PACKAGE



4214771/A 05/2017

NOTES:

1. All controlling linear dimensions are in inches. Dimensions in brackets are in millimeters. Any dimension in brackets or parenthesis are for reference only. Dimensioning and tolerancing per ASME Y14.5M.
2. This drawing is subject to change without notice.
3. This package is hermetically sealed with a ceramic lid using glass frit.
4. Index point is provided on cap for terminal identification only and on press ceramic glass frit seal only.
5. Falls within MIL-STD-1835 and GDIP1-T14.

EXAMPLE BOARD LAYOUT

J0014A

CDIP - 5.08 mm max height

CERAMIC DUAL IN LINE PACKAGE



LAND PATTERN EXAMPLE
NON-SOLDER MASK DEFINED
SCALE: 5X

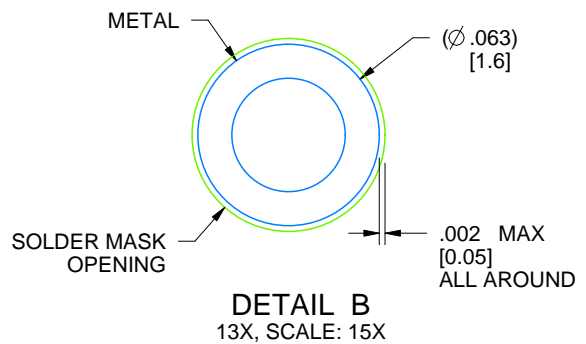

4214771/A 05/2017

D (R-PDSO-G14)

PLASTIC SMALL OUTLINE

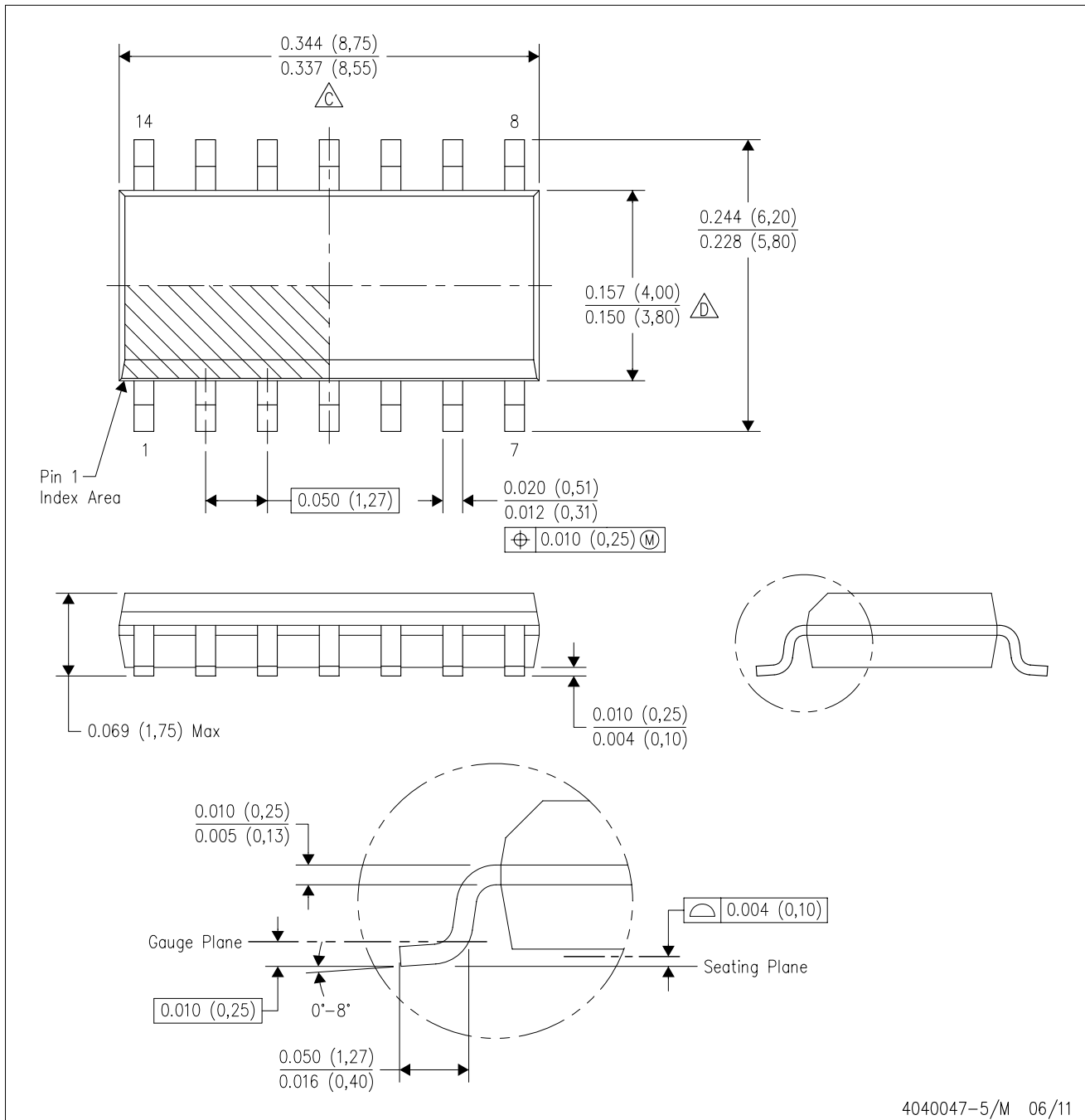

4040047-5/M 06/11

- NOTES:
- A. All linear dimensions are in inches (millimeters).
 - B. This drawing is subject to change without notice.
 - $\triangle C$ Body length does not include mold flash, protrusions, or gate burrs. Mold flash, protrusions, or gate burrs shall not exceed 0.006 (0,15) each side.
 - $\triangle D$ Body width does not include interlead flash. Interlead flash shall not exceed 0.017 (0,43) each side.
 - E. Reference JEDEC MS-012 variation AB.

PW (R-PDSO-G14)

PLASTIC SMALL OUTLINE

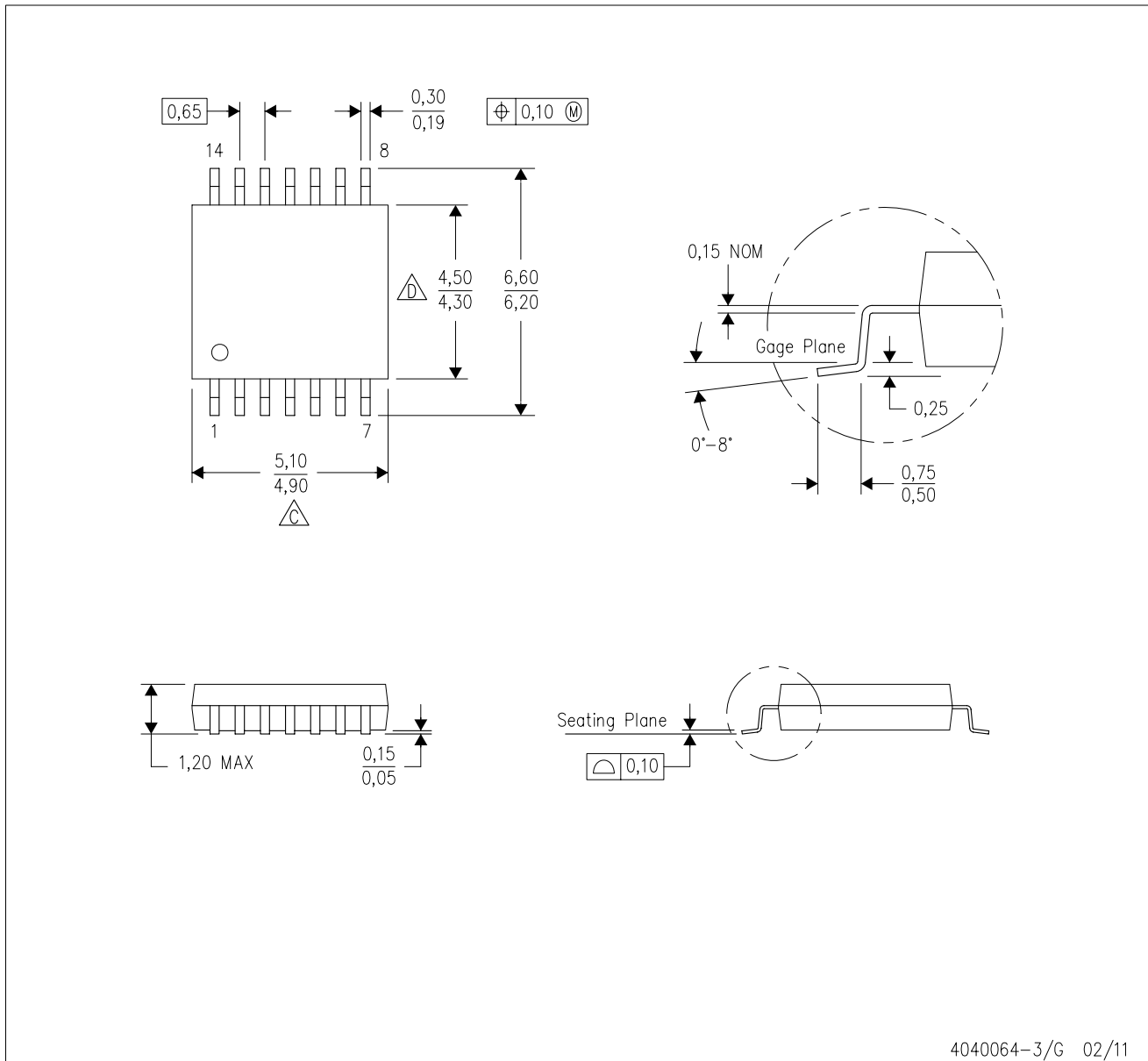

4040064-3/G 02/11

- NOTES:
- A. All linear dimensions are in millimeters. Dimensioning and tolerancing per ASME Y14.5M-1994.
 - B. This drawing is subject to change without notice.
 - C. Body length does not include mold flash, protrusions, or gate burrs. Mold flash, protrusions, or gate burrs shall not exceed 0,15 each side.
 - D. Body width does not include interlead flash. Interlead flash shall not exceed 0,25 each side.
 - E. Falls within JEDEC MO-153

N (R-PDIP-T**)

PLASTIC DUAL-IN-LINE PACKAGE

16 PINS SHOWN



- NOTES:
- A. All linear dimensions are in inches (millimeters).
 - B. This drawing is subject to change without notice.
 - Falls within JEDEC MS-001, except 18 and 20 pin minimum body length (Dim A).
 - The 20 pin end lead shoulder width is a vendor option, either half or full width.

IMPORTANT NOTICE AND DISCLAIMER

TI PROVIDES TECHNICAL AND RELIABILITY DATA (INCLUDING DATA SHEETS), DESIGN RESOURCES (INCLUDING REFERENCE DESIGNS), APPLICATION OR OTHER DESIGN ADVICE, WEB TOOLS, SAFETY INFORMATION, AND OTHER RESOURCES "AS IS" AND WITH ALL FAULTS, AND DISCLAIMS ALL WARRANTIES, EXPRESS AND IMPLIED, INCLUDING WITHOUT LIMITATION ANY IMPLIED WARRANTIES OF MERCHANTABILITY, FITNESS FOR A PARTICULAR PURPOSE OR NON-INFRINGEMENT OF THIRD PARTY INTELLECTUAL PROPERTY RIGHTS.

These resources are intended for skilled developers designing with TI products. You are solely responsible for (1) selecting the appropriate TI products for your application, (2) designing, validating and testing your application, and (3) ensuring your application meets applicable standards, and any other safety, security, regulatory or other requirements.

These resources are subject to change without notice. TI grants you permission to use these resources only for development of an application that uses the TI products described in the resource. Other reproduction and display of these resources is prohibited. No license is granted to any other TI intellectual property right or to any third party intellectual property right. TI disclaims responsibility for, and you will fully indemnify TI and its representatives against, any claims, damages, costs, losses, and liabilities arising out of your use of these resources.

TI's products are provided subject to [TI's Terms of Sale](#) or other applicable terms available either on [ti.com](https://www.ti.com) or provided in conjunction with such TI products. TI's provision of these resources does not expand or otherwise alter TI's applicable warranties or warranty disclaimers for TI products.

TI objects to and rejects any additional or different terms you may have proposed.

Mailing Address: Texas Instruments, Post Office Box 655303, Dallas, Texas 75265
Copyright © 2023, Texas Instruments Incorporated