

THS413x High-Speed, Low-Noise, Fully-Differential I/O Amplifiers

1 Features

- High performance
 - Bandwidth: 170 MHz ($V_{CC} = \pm 15$ V, $G = 1$ V/V)
 - Slew rate: 51 V/ μ s
 - Gain bandwidth product: 215 MHz
 - Distortion: -102 dBc THD at 2 V_{PP} , 250 kHz
- Voltage noise
 - 1/f voltage noise corner: 350 Hz
 - 1.25 nV/ $\sqrt{\text{Hz}}$ input-referred noise
- Single supply operating range: 5 V to 30 V
- Quiescent current (shutdown): 860 μ A (THS4130)

2 Applications

- Single-ended to differential conversion
- Differential ADC driver
- Differential antialiasing
- Differential transmitter and receiver
- Output level shifter
- [Medical ultrasound](#)

3 Description

The THS413x device is one in a family of fully-differential input/differential output devices fabricated using Texas Instruments state-of-the-art high voltage complementary bipolar process.

The THS413x is made of a true fully-differential signal path from input to output and high supply capability of up to ± 15 V. This design leads to an excellent common-mode noise rejection performance (95 dB at 800 kHz) and total harmonic distortion (-102 dBc at 2 V_{PP} , 250 kHz). The wide supply range allows high-voltage differential signal chains to benefit from its improved headroom and dynamic range without adding separate amplifiers for each polarity of the differential signal.

The THS413x is characterized for operation over the wide temperature range of -40°C to $+85^{\circ}\text{C}$.

Device Information⁽¹⁾

PART NUMBER	PACKAGE ⁽²⁾	BODY SIZE (NOM)
THS4130	SOIC (8)	4.90 mm \times 3.91 mm
	MSOP (8)	3.00 mm \times 3.00 mm
	MSOP-PowerPAD™ (8)	3.00 mm \times 3.00 mm
THS4131	SOIC (8)	4.90 mm \times 3.91 mm
	MSOP (8)	3.00 mm \times 3.00 mm
	MSOP-PowerPAD (8)	3.00 mm \times 3.00 mm

- For all available packages, see the orderable addendum at the end of the data sheet.
- See the [device comparison table](#).

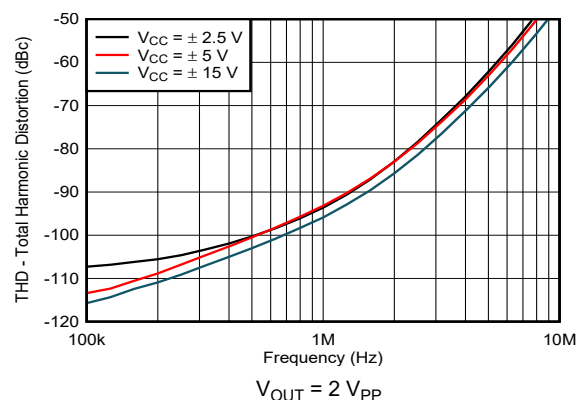
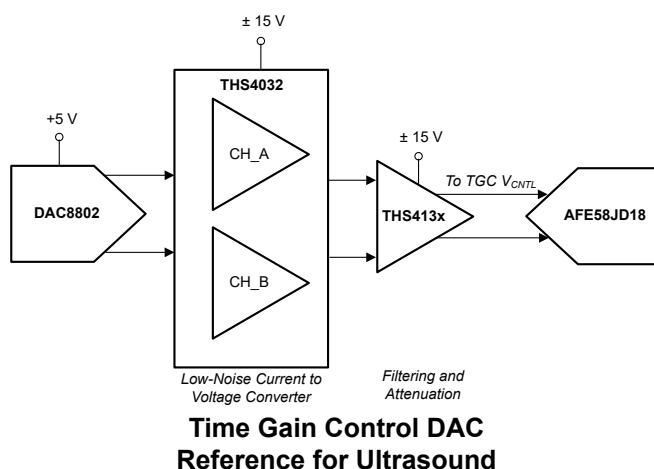

Table of Contents

1 Features	1	8.3 Feature Description.....	22
2 Applications	1	8.4 Device Functional Modes.....	22
3 Description	1	9 Application and Implementation	24
4 Revision History	2	9.1 Application Information.....	24
5 Device Comparison Tables	5	9.2 Typical Application.....	26
6 Pin Configuration and Functions	5	10 Power Supply Recommendations	28
7 Specifications	6	11 Layout	28
7.1 Absolute Maximum Ratings.....	6	11.1 Layout Guidelines.....	28
7.2 ESD Ratings.....	6	11.2 Layout Example.....	29
7.3 Recommended Operating Conditions.....	6	11.3 General PowerPAD Design Considerations.....	30
7.4 Thermal Information.....	7	12 Device and Documentation Support	31
7.5 Electrical Characteristics: THS413xD, THS413xDGK.....	7	12.1 Documentation Support.....	31
7.6 Electrical Characteristics: THS413xDGN.....	9	12.2 Receiving Notification of Documentation Updates.....	31
7.7 Typical Characteristics: THS413xD, THS413xDGK.....	11	12.3 Support Resources.....	31
7.8 Typical Characteristics: THS413xDGN.....	16	12.4 Trademarks.....	31
8 Detailed Description	21	12.5 Electrostatic Discharge Caution.....	31
8.1 Overview.....	21	12.6 Glossary.....	31
8.2 Functional Block Diagram.....	21	13 Mechanical, Packaging, and Orderable Information	31

4 Revision History

NOTE: Page numbers for previous revisions may differ from page numbers in the current version.

Changes from Revision J (March 2022) to Revision K (August 2022)	Page
• Updated thermal specifications for DGK package in <i>Thermal Information</i> table.....	7
• Changed title of <i>Electrical Characteristics: THS413xD</i> to <i>Electrical Characteristics: THS413xD, THS413xDGK</i>	7
• Changed title of <i>Electrical Characteristics: THS413xDGK, THS413xDGN</i> table to <i>Electrical Characteristics: THS413xDGN</i>	9
• Changed title of <i>Typical Characteristics: THS413xD</i> to <i>Typical Characteristics: THS413xD, THS413xDGK</i> ..	11
• Changed title of <i>Typical Characteristics</i> to <i>Typical Characteristics: THS413xDGN</i>	16

Changes from Revision I (August 2015) to Revision J (March 2022)	Page
• Updated the numbering format for tables, figures, and cross-references throughout the document.....	1
• Updated <i>Features</i> section.....	1
• Updated <i>Applications</i> section.....	1
• Updated <i>Description</i> section	1
• Updated <i>Available Device Packages</i> table.....	5
• Removed <i>Device Description</i> table.....	5
• Updated <i>Pin Configuration and Functions</i> section.....	5
• Changed footnote 1 on <i>Absolute Maximum Ratings</i> table to add additional clarification	6
• Removed minimum supply voltage on <i>Absolute Maximum Ratings</i> table.....	6
• Added supply turn-on/off dV/dT specification to <i>Absolute Maximum Ratings</i> table.....	6
• Removed continuous total power dissipation specification in <i>Absolute Maximum Ratings</i> table	6
• Changed Differential input voltage specification from ± 6 to ± 1.5 on <i>Absolute Maximum Ratings</i> table	6
• Added continuous input current specification to <i>Absolute Maximum Ratings</i> table	6
• Changed charged-device model (CDM) reference from JESD22-C101 to JS-002 in <i>ESD Ratings</i> table	6
• Updated thermal specifications for D package in <i>Thermal Information</i> table.....	7
• Changed $R_{\theta JA}$ from 114.5°C/W to 126.3°C/W in <i>Thermal Information</i> table.....	7
• Changed VSSOP and HVSSOP to MSOP and MSOP-PowerPad in <i>Thermal Information</i> table.....	7
• Changed $R_{\theta JC(top)}$ from 60.3°C/W to 67.3°C/W in <i>Thermal Information</i> table.....	7
• Changed small signal bandwidth at $G = 1$, $V_{CC} = 5$ V from 125 MHz to 165 MHz in <i>Electrical Characteristics: THS413xD</i> table.....	7

- Changed small signal bandwidth at $G = 1$, $V_{CC} = \pm 5\text{ V}$ from 135 MHz to 166 MHz in *Electrical Characteristics: THS413xD table*..... 7
- Changed small signal bandwidth at $G = 1$, $V_{CC} = \pm 15\text{ V}$ from 150 MHz to 170 MHz in *Electrical Characteristics: THS413xD table*..... 7
- Changed small signal bandwidth at $G = 2$, $V_{CC} = 5\text{ V}$ from 80 MHz to 97 MHz in *Electrical Characteristics: THS413xD table*..... 7
- Changed small signal bandwidth at $G = 2$, $V_{CC} = \pm 5\text{ V}$ from 85 MHz to 98 MHz in *Electrical Characteristics: THS413xD table*..... 7
- Changed small signal bandwidth at $G = 2$, $V_{CC} = \pm 15\text{ V}$ from 90 MHz to 100 MHz in *Electrical Characteristics: THS413xD table*..... 7
- Changed slew rate from 52 V/ μs to 67 V/ μs in *Electrical Characteristics: THS413xD table*..... 7
- Changed settling time to 0.1% typical specification from 78 ns to 39 ns on *Electrical Characteristics: THS413xD table* 7
- Changed settling time to 0.01% typical specification from 213 ns to 61 ns on *Electrical Characteristics: THS413xD table* 7
- Changed THD typical at $V_{CC} = 5\text{ V}$, $f = 250\text{ kHz}$ from -95 dBc to -101 dBc in *Electrical Characteristics: THS413xD table* 7
- Changed THD typical at $V_{CC} = 5\text{ V}$, $f = 1\text{ MHz}$ from -81 dBc to -87 dBc in *Electrical Characteristics: THS413xD table* 7
- Changed THD typical at $V_{CC} = \pm 5\text{ V}$, $f = 250\text{ kHz}$ from -96 dBc to -100 dBc in *Electrical Characteristics: THS413xD table* 7
- Changed THD typical at $V_{CC} = \pm 5\text{ V}$, $f = 1\text{ MHz}$ from -80 dBc to -87 dBc in *Electrical Characteristics: THS413xD table* 7
- Changed THD typical at $V_{CC} = \pm 15\text{ V}$, $f = 250\text{ kHz}$ from -97 dBc to -102 dBc in *Electrical Characteristics: THS413xD table* 7
- Changed THD typical at $V_{CC} = \pm 15\text{ V}$, $f = 1\text{ MHz}$ from -80 dBc to -88 dBc in *Electrical Characteristics: THS413xD table* 7
- Changed THD typical at $V_{CC} = \pm 5\text{ V}$, $f = 250\text{ kHz}$, $V_O = 4V_{PP}$ from -91 dBc to -94 dBc in *Electrical Characteristics: THS413xD table* 7
- Changed THD typical at $V_{CC} = \pm 5\text{ V}$, $f = 1\text{ MHz}$, $V_O = 4V_{PP}$ from -75 dBc to -79 dBc in *Electrical Characteristics: THS413xD table* 7
- Changed THD typical at $V_{CC} = \pm 15\text{ V}$, $f = 250\text{ kHz}$, $V_O = 4V_{PP}$ from -91 dBc to -95 dBc..... 7
- Changed THD typical at $V_{CC} = \pm 15\text{ V}$, $f = 1\text{ MHz}$, $V_O = 4V_{PP}$ from -75 dBc to -80 dBc in *Electrical Characteristics: THS413xD table* 7
- Changed SFDR typical at $V_{CC} = \pm 2.5\text{ V}$, $V_O = 2\text{ V}_{PP}$ from 97 dB to 103 dB in *Electrical Characteristics: THS413xD table* 7
- Changed SFDR typical at $V_{CC} = \pm 5\text{ V}$, $V_O = 2\text{ V}_{PP}$ from 98 dB to 106 dB in *Electrical Characteristics: THS413xD table* 7
- Changed SFDR typical at $V_{CC} = \pm 15\text{ V}$, $V_O = 2\text{ V}_{PP}$ from 99 dB to 108 dB in *Electrical Characteristics: THS413xD table* 7
- Changed SFDR typical at $V_{CC} = \pm 5\text{ V}$, $V_O = 4\text{ V}_{PP}$ from 98 dB to 106 dB in *Electrical Characteristics: THS413xD table* 7
- Changed SFDR typical at $V_{CC} = \pm 15\text{ V}$, $V_O = 4\text{ V}_{PP}$ from 95 dB to 100 dB in *Electrical Characteristics: THS413xD table* 7
- Changed input voltage noise typical from 1.3 nV/ $\sqrt{\text{Hz}}$ to 1.25 nV/ $\sqrt{\text{Hz}}$ on *Electrical Characteristics: THS413xD table*..... 7
- Changed input current noise typical from 1.3 nV/ $\sqrt{\text{Hz}}$ to 1.7 nV/ $\sqrt{\text{Hz}}$ on *Electrical Characteristics: THS413xD table*..... 7
- Changed common-mode input offset voltage maximum from 3.5 mV to 5.5 mV in *Electrical Characteristics: THS413xD table* 7
- Changed typical input offset voltage drift from 4.5 $\mu\text{V}/^\circ\text{C}$ to 2 $\mu\text{V}/^\circ\text{C}$ in *Electrical Characteristics: THS413xD table* 7
- Changed typical input bias current spec from 2 μA to 5 μA in *Electrical Characteristics: THS413xD table* 7
- Changed Max input bias current limit from 6 μA to 15.4 μA in *Electrical Characteristics: THS413xD table* 7
- Changed typical offset current drift from 2 nA/ $^\circ\text{C}$ to 1 nA/ $^\circ\text{C}$ in *Electrical Characteristics: THS413xD table* 7

• Removed input resistance specification from <i>Electrical Characteristics: THS413xD</i> table	7
• Added common-mode input resistance and differential input resistance specifications to <i>Electrical Characteristics: THS413xD</i> table	7
• Removed input capacitance, closed loop specification from <i>Electrical Characteristics: THS413xD</i> table	7
• Added common-mode input capacitance, closed loop and differential input capacitance, closed loop specifications to <i>Electrical Characteristics: THS413xD</i> table	7
• Changed minimum output current at ± 15 V, $T_A = 25^\circ\text{C}$, from 60 mA to 65 mA in <i>Electrical Characteristics: THS413xD</i> table	7
• Changed minimum output current at ± 15 V, full temperature range, from 65 mA to 60 mA in <i>Electrical Characteristics: THS413xD</i> table	7
• Changed Typical I_{CC} at $V_{CC} = \pm 5$ V from 12.3 mA to 10.4 mA in <i>Electrical Characteristics: THS413xD</i> table	7
• Changed title of <i>Electrical Characteristics</i> table to <i>Electrical Characteristics: THS413xDGK, THS413xDGN</i>	9
• Changed min/max single power supply range from 4V/33 V to 5V/30 V on <i>Electrical Characteristics: THS413xDGK, THS413xDGN</i> table to align with recommended operating conditions.....	9
• Changed min/max dual power supply range from ± 2 V/ ± 16.5 V to ± 2.5 V/ ± 15 V on <i>Electrical Characteristics: THS413xDGK, THS413xDGN</i> table to align with recommended operating conditions.....	9
• Removed <i>Dissipation Ratings</i> table.....	9
• Changed minimum output current under $V_{CC} = \pm 15$ V, $R_L = 7 \Omega$, $T_A = +25^\circ\text{C}$, from 60 mA to 65 mA on <i>Electrical Characteristics: THS413xDGK, THS413xDGN</i> table.....	9
• Changed minimum output current under $V_{CC} = \pm 15$ V, $R_L = 7 \Omega$, $T_A =$ full range, from 65 mA to 60 mA on <i>Electrical Characteristics: THS413xDGK, THS413xDGN</i> table.....	9
• Added new Typical Characteristics section for D package.....	11
• Updated <i>Overview</i> Section.....	21
• Updated <i>Feature Description</i> section.....	22
• Updated <i>Power-Down Mode</i> section.....	22
• Added <i>Output Common-Mode Voltage</i> section.....	24
• Updated <i>Resistor Matching</i> section.....	24
• Updated <i>Driving a Capacitive Load</i> section.....	25
• Updated <i>Data Converters</i> section.....	25
• Updated <i>Single-Supply Applications</i> section.....	26
• Updated large-signal frequency response figure in <i>Application Curve</i> section	28
• Updated <i>Power Supply Recommendations</i> section.....	28
• Updated <i>Layout Guidelines</i> section.....	28
• Updated <i>Layout Example</i> section.....	29
• Changed list of documentation in <i>Related Documentation</i> section.....	31

Changes from Revision H (May 2011) to Revision I (August 2015)	Page
---	-------------

• Added <i>Pin Configuration and Functions</i> section, <i>ESD Ratings</i> table, <i>Feature Description</i> section, <i>Device Functional Modes</i> , <i>Application and Implementation</i> section, <i>Power Supply Recommendations</i> section, <i>Layout</i> section, <i>Device and Documentation Support</i> section, and <i>Mechanical, Packaging, and Orderable Information</i> section.....	1
---	---

Changes from Revision G (January 2010) to Revision H (May 2011)	Page
--	-------------

• Changed footnote A in <i>Views of Thermally-Enhanced DGN Package</i>	30
--	----

Changes from Revision F (January 2006) to Revision G (January 2010)	Page
--	-------------

• Changed DGK package specifications in the <i>Dissipation Rating</i> table.....	6
--	---

5 Device Comparison Tables

Table 5-1. Available Device Packages

PACKAGED DEVICES			
T _A	SOIC (D)	MSOP PowerPAD™ (DGN)	MSOP (DGK)
0°C to +70°C	THS4130CD	THS4130CDGN	THS4130CDGK
	THS4131CD	THS4131CDGN	THS4131CDGK
-40°C to +85°C	THS4130ID	THS4130IDGN	THS4130IDGK
	THS4131ID	THS4131IDGN	THS4131IDGK

6 Pin Configuration and Functions

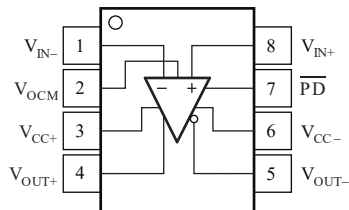

Figure 6-1. D, DGN, or DGK Package, 8-Pin SOIC, MSOP, or MSOP-PowerPAD THS4130 (Top View)

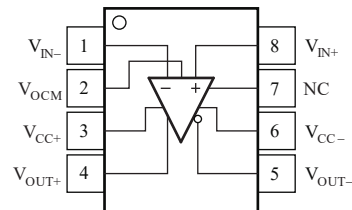

Figure 6-2. D, DGN, or DGK Package, 8-Pin SOIC, MSOP, or MSOP-PowerPAD THS4131 (Top View)

Table 6-1. Pin Functions

NAME	PIN		TYPE ⁽¹⁾	DESCRIPTION
	THS4130	THS4131		
NC	—	7	—	No connect
$\overline{\text{PD}}$	7	—	I	Active low power-down pin
V _{CC+}	3	3	I/O	Positive supply voltage pin
V _{CC-}	6	6	I/O	Negative supply voltage pin
V _{IN-}	1	1	I	Negative input pin
V _{OCM}	2	2	I	Common mode input pin
V _{OUT+}	4	4	O	Positive output pin
V _{OUT-}	5	5	O	Negative output pin
V _{IN+}	8	8	I	Positive input pin

(1) I = input, O = output

7 Specifications

7.1 Absolute Maximum Ratings

over operating free-air temperature range (unless otherwise noted)⁽¹⁾

		MIN	MAX	UNIT	
V _I	Input voltage	-V _{CC}	+V _{CC}	V	
V _{CC-} to V _{CC+}	Supply voltage		33	V	
	Supply turn-on/off dV/dT ⁽²⁾		1.7	V/μs	
I _O ⁽³⁾	Output current		150	mA	
V _{ID}	Differential input voltage	-1.5	1.5	V	
I _{IN}	Continuous Input Current		10	mA	
T _J ⁽⁴⁾	Maximum junction temperature		150	°C	
T _J ⁽⁵⁾	Maximum junction temperature, continuous operation, long-term reliability		125	°C	
T _A	Operating free-air temperature	C-suffix	0	70	°C
		I-suffix	-40	85	°C
T _{stg}	Storage temperature	-65	150	°C	

- (1) Operation outside the Absolute Maximum Ratings may cause permanent device damage. Absolute maximum ratings do not imply functional operation of the device at these or any other conditions beyond those listed under Recommended Operating Conditions. If briefly operating outside the Recommended Operating Conditions but within the Absolute Maximum Ratings, the device may not sustain damage, but it may not be fully functional. Operating the device in this manner may affect device reliability, functionality, performance, and shorten the device lifetime.
- (2) Staying below this specification ensures that the edge-triggered ESD absorption devices across the supply pins remain off.
- (3) The THS413x may incorporate a PowerPAD on the underside of the chip. This acts as a heatsink and must be connected to a thermally dissipative plane for proper power dissipation. Failure to do so may result in exceeding the maximum junction temperature which could permanently damage the device. See TI technical briefs [SLMA002](#) and [SLMA004](#) for more information about using the PowerPAD thermally-enhanced package.
- (4) The absolute maximum temperature under any condition is limited by the constraints of the silicon process.
- (5) The maximum junction temperature for continuous operation is limited by package constraints. Operation above this temperature may result in reduced reliability and/or lifetime of the device.

7.2 ESD Ratings

			VALUE	UNIT
THS4130: D, DGN, OR DGK PACKAGES				
V _(ESD)	Electrostatic discharge	Human-body model (HBM), per ANSI/ESDA/JEDEC JS-001 ⁽¹⁾	±2500	V
		Charged-device model (CDM), per ANSI/ESDA/JEDEC JS-002 ⁽²⁾	±1500	
THS4131: D, DGN, OR DGK PACKAGES				
V _(ESD)	Electrostatic discharge	Human-body model (HBM), per ANSI/ESDA/JEDEC JS-001 ⁽¹⁾	±2500	V
		Charged-device model (CDM), per ANSI/ESDA/JEDEC JS-002 ⁽²⁾	±1500	

- (1) JEDEC document JEP155 states that 500-V HBM allows safe manufacturing with a standard ESD control process.
- (2) JEDEC document JEP157 states that 250-V CDM allows safe manufacturing with a standard ESD control process.

7.3 Recommended Operating Conditions

over operating free-air temperature range (unless otherwise noted)

		MIN	NOM	MAX	UNIT
V _{CC+} to V _{CC-}	Dual supply	±2.5		±15	V
	Single supply	5		30	
T _A	C-suffix	0		70	°C
	I-suffix	-40		85	

7.4 Thermal Information

THERMAL METRIC ⁽¹⁾		THS413x			UNIT
		D (SOIC)	DGN (MSOP-PowerPAD)	DGK (MSOP)	
		8 PINS	8 PINS	8 PINS	
R _{θJA}	Junction-to-ambient thermal resistance	126.3	55.8	147.3	°C/W
R _{θJC(top)}	Junction-to-case (top) thermal resistance	67.3	61.6	37.9	°C/W
R _{θJB}	Junction-to-board thermal resistance	69.8	34.5	83.2	°C/W
ψ _{JT}	Junction-to-top characterization parameter	19.5	13.8	0.9	°C/W
ψ _{JB}	Junction-to-board characterization parameter	69.0	34.4	81.6	°C/W
R _{θJC(bot)}	Junction-to-case (bottom) thermal resistance	n/a	8.4	n/a	°C/W

(1) For more information about traditional and new thermal metrics, see the Semiconductor and IC Package Thermal Metrics application report, [SPRA953](#).

7.5 Electrical Characteristics: THS413xD, THS413xDGK

V_{CC} = ±5 V, Gain = 1 V/V, R_F = 390 Ω, R_L = 800 Ω, and T_A = +25°C, unless otherwise noted.

PARAMETER		TEST CONDITIONS		MIN	TYP	MAX	UNIT
DYNAMIC PERFORMANCE							
BW	Small-signal bandwidth (–3 dB), single-ended input, differential output, V _I = 63 mV _{PP}	V _{CC} = 5 V	Gain = 1, R _F = 390 Ω	165		MHz	
		V _{CC} = ±5 V		166			
		V _{CC} = ±15 V		170			
		V _{CC} = 5 V	Gain = 2, R _F = 750 Ω	97			
		V _{CC} = ±5 V		98			
		V _{CC} = ±15 V		100			
SR	Slew rate ⁽²⁾			67	V/μs		
t _s	Settling time to 0.1%	Step voltage = 2 V		39		ns	
	Settling time to 0.01%			61			
DISTORTION PERFORMANCE							
THD	Total harmonic distortion, differential input, differential output, V _O = 2 V _{PP}	V _{CC} = 5 V	f = 250 kHz	–101		dBc	
			f = 1 MHz	–87			
		V _{CC} = ±5 V	f = 250 kHz	–100			
			f = 1 MHz	–87			
		V _{CC} = ±15 V	f = 250 kHz	–102			
			f = 1 MHz	–88			
	V _O = 4 V _{PP}	V _{CC} = ±5 V	f = 250 kHz	–94			
			f = 1 MHz	–79			
		V _{CC} = ±15 V	f = 250 kHz	–95			
			f = 1 MHz	–80			
SFDR	Spurious-free dynamic range, differential input, differential output, f = 250 kHz	V _O = 2 V _{PP}	V _{CC} = ±2.5	103		dBc	
			V _{CC} = ±5	106			
			V _{CC} = ±15	108			
		V _O = 4 V _{PP}	V _{CC} = ±5	98			
			V _{CC} = ±15	100			
IMD3	Third intermodulation distortion	V _{I(PP)} = 4 V, F ₁ = 3 MHz, F ₂ = 3.5 MHz		–53		dBc	
OIP3	Third-order intercept			41.5		dB	
NOISE PERFORMANCE							
V _n	Input voltage noise	f = 10 kHz		1.25	nV/√Hz		
I _n	Input current noise	f = 10 kHz		1.7	pA/√Hz		

7.5 Electrical Characteristics: THS413xD, THS413xDGK (continued)

$V_{CC} = \pm 5\text{ V}$, Gain = 1 V/V, $R_F = 390\ \Omega$, $R_L = 800\ \Omega$, and $T_A = +25^\circ\text{C}$, unless otherwise noted.

PARAMETER		TEST CONDITIONS		MIN	TYP	MAX	UNIT
DC PERFORMANCE							
	Open-loop gain	$T_A = +25^\circ\text{C}$		71	78		dB
		$T_A = \text{full range}$		69			
V_{OS}	Input offset voltage	$T_A = +25^\circ\text{C}$			± 0.2	2	mV
		$T_A = \text{full range}^{(1)}$				3	
	Common-mode input offset voltage, referred to V_{OCM}				0.2	5.5	mV
	Input offset voltage drift	$T_A = \text{full range}^{(1)}$			2		$\mu\text{V}/^\circ\text{C}$
I_{IB}	Input bias current	$T_A = \text{full range}^{(1)}$			5	15.4	μA
I_{OS}	Input offset current	$T_A = \text{full range}^{(1)}$			100	500	nA
	Input offset current drift				1		$\text{nA}/^\circ\text{C}$
INPUT CHARACTERISTICS							
CMRR	Common-mode rejection ratio	$T_A = \text{full range}^{(1)}$		80	95		dB
V_{ICR}	Common-mode input voltage range			-3.77 to 4.3	-4 to 4.5		V
R_{I_CM}	Common-mode input resistance	Measured into each input terminal			215		M Ω
R_{I_DIFF}	Differential input resistance					10	
C_{I_CM}	Common-mode input capacitance, closed loop	Measured into each input terminal			1.4		pF
C_{I_DIFF}	Differential input capacitance, closed loop					2.5	
OUTPUT CHARACTERISTICS							
r_o	Output resistance	Open loop			41		Ω
	Output voltage swing	$V_{CC} = 5\text{ V}, R_L = 1\text{ k}\Omega$	$T_A = +25^\circ\text{C}$	1.2 to 3.8	0.9 to 4.1		V
			$T_A = \text{full range}^{(1)}$	1.3 to 3.7	± 4		
		$V_{CC} = \pm 5\text{ V}, R_L = 1\text{ k}\Omega$	$T_A = +25^\circ\text{C}$	± 3.7			
			$T_A = \text{full range}^{(1)}$	± 3.6			
		$V_{CC} = \pm 15\text{ V}, R_L = 1\text{ k}\Omega$	$T_A = +25^\circ\text{C}$	± 11.5	± 12.4		
			$T_A = \text{full range}^{(1)}$	± 11.2			
I_O	Output current	$V_{CC} = 5\text{ V}, R_L = 7\ \Omega$	$T_A = +25^\circ\text{C}$	25	45		mA
			$T_A = \text{full range}$	20			
		$V_{CC} = \pm 5\text{ V}, R_L = 7\ \Omega$	$T_A = +25^\circ\text{C}$	30	55		
			$T_A = \text{full range}^{(1)}$	28			
		$V_{CC} = \pm 15\text{ V}, R_L = 7\ \Omega$	$T_A = +25^\circ\text{C}$	65	85		
			$T_A = \text{full range}^{(1)}$	60			
POWER SUPPLY							
I_{CC}	Quiescent current	$V_{CC} = \pm 5\text{ V}$	$T_A = +25^\circ\text{C}$		10.4	15	mA
			$T_A = \text{full range}^{(1)}$			16	
		$V_{CC} = \pm 15\text{ V}$	$T_A = +25^\circ\text{C}$		13		
$I_{CC(SD)}$	Quiescent current (shutdown) (THS4130 only) ⁽³⁾	$\overline{PD} = -5\text{ V}$	$T_A = +25^\circ\text{C}$		0.86	1.4	mA
			$T_A = \text{full range}^{(1)}$			1.5	
PSRR	Power-supply rejection ratio (dc)		$T_A = +25^\circ\text{C}$	73	98		dB
			$T_A = \text{full range}^{(1)}$	70			

(1) The full range temperature is 0°C to $+70^\circ\text{C}$ for the C-suffix, and -40°C to $+85^\circ\text{C}$ for the I-suffix.

(2) Slew rate is measured from an output level range of 25% to 75%.

(3) For detailed information on the behavior of the power-down circuit, see the [Power-Down Mode section](#).

7.6 Electrical Characteristics: THS413xDGN

$V_{CC} = \pm 5\text{ V}$, $R_L = 800\ \Omega$, and $T_A = +25^\circ\text{C}$, unless otherwise noted. ⁽¹⁾

PARAMETER		TEST CONDITIONS		MIN	TYP	MAX	UNIT
DYNAMIC PERFORMANCE							
BW	Small-signal bandwidth (–3 dB), single-ended input, differential output, $V_I = 63\text{ mV}_{PP}$	$V_{CC} = 5$	Gain = 1, $R_f = 390\ \Omega$		125		MHz
		$V_{CC} = \pm 5$	Gain = 1, $R_f = 390\ \Omega$		135		
		$V_{CC} = \pm 15$	Gain = 1, $R_f = 390\ \Omega$		150		
	Small-signal bandwidth (–3 dB), single-ended input, differential output, $V_I = 63\text{ mV}_{PP}$	$V_{CC} = 5$	Gain = 2, $R_f = 750\ \Omega$		80		
		$V_{CC} = \pm 5$	Gain = 2, $R_f = 750\ \Omega$		85		
		$V_{CC} = \pm 15$	Gain = 2, $R_f = 750\ \Omega$		90		
SR	Slew rate ⁽²⁾	Gain = 1			52		V/ μs
t_s	Settling time to 0.1%	Step voltage = 2 V, gain = 1			78		ns
	Settling time to 0.01%	Step voltage = 2 V, gain = 1			213		
DISTORTION PERFORMANCE							
THD	Total harmonic distortion, differential input, differential output, gain = 1, $R_f = 390\ \Omega$, $R_L = 800\ \Omega$, $V_O = 2\text{ V}_{PP}$	$V_{CC} = 5$	f = 250 kHz		–95		dBc
			f = 1 MHz		–81		
		$V_{CC} = \pm 5$	f = 250 kHz		–96		
			f = 1 MHz		–80		
		$V_{CC} = \pm 15$	f = 250 kHz		–97		
			f = 1 MHz		–80		
	$V_O = 4\text{ V}_{PP}$	$V_{CC} = \pm 5$	f = 250 kHz		–91		
			f = 1 MHz		–75		
SFDR	Spurious-free dynamic range, differential input, differential output, gain = 1, $R_f = 390\ \Omega$, $R_L = 800\ \Omega$, f = 250 kHz	$V_O = 2\text{ V}_{PP}$	$V_{CC} = \pm 2.5$		97		dB
			$V_{CC} = \pm 5$		98		
			$V_{CC} = \pm 15$		99		
		$V_O = 4\text{ V}_{PP}$	$V_{CC} = \pm 5$		93		
			$V_{CC} = \pm 15$		95		
Third intermodulation distortion		$V_{I(PP)} = 4\text{ V}$, G = 1, F1 = 3 MHz, F2 = 3.5 MHz			–53		dBc
Third-order intercept		$V_{I(PP)} = 4\text{ V}$, G = 1, F1 = 3 MHz, F2 = 3.5 MHz			41.5		dB
NOISE PERFORMANCE							
V_n	Input voltage noise	f = 10 kHz			1.3		nV/ $\sqrt{\text{Hz}}$
I_n	Input current noise	f = 10 kHz			1		pA/ $\sqrt{\text{Hz}}$
DC PERFORMANCE							
Open-loop gain		$T_A = +25^\circ\text{C}$		71	78		dB
		$T_A = \text{full range}$		69			
$V_{(OS)}$	Input offset voltage	$T_A = +25^\circ\text{C}$			0.2	2	mV
		$T_A = \text{full range}$				3	
	Common-mode input offset voltage, referred to V_{OCM}	$T_A = +25^\circ\text{C}$			0.2	3.5	
	Input offset voltage drift	$T_A = \text{full range}$			4.5		
I_{IB}	Input bias current	$T_A = \text{full range}$			2	6	μA
I_{OS}	Input offset current	$T_A = \text{full range}$			100	500	nA
Offset drift					2		nA/ $^\circ\text{C}$

7.6 Electrical Characteristics: THS413xDGN (continued)

$V_{CC} = \pm 5\text{ V}$, $R_L = 800\ \Omega$, and $T_A = +25^\circ\text{C}$, unless otherwise noted. ⁽¹⁾

PARAMETER		TEST CONDITIONS		MIN	TYP	MAX	UNIT
INPUT CHARACTERISTICS							
CMRR	Common-mode rejection ratio	$T_A = \text{full range}$		80	95		dB
V_{ICR}	Common-mode input voltage range			-3.77 to 4.3	-4 to 4.5		V
R_i	Input resistance	Measured into each input terminal			34		M Ω
C_i	Input capacitance, closed loop				4		pF
r_o	Output resistance	Open loop			41		Ω
OUTPUT CHARACTERISTICS							
Output voltage swing		$V_{CC} = 5\text{ V}$	$T_A = +25^\circ\text{C}$	1.2 to 3.8		0.9 to 4.1	
			$T_A = \text{full range}$	1.3 to 3.7		± 4	
		$V_{CC} = \pm 5\text{ V}$	$T_A = +25^\circ\text{C}$	± 3.7			
			$T_A = \text{full range}$	± 3.6			
		$V_{CC} = \pm 15\text{ V}$	$T_A = +25^\circ\text{C}$	± 10.5		± 12.4	
			$T_A = \text{full range}$	± 10.2			
I_o	Output current	$V_{CC} = 5\text{ V}, R_L = 7\ \Omega$	$T_A = +25^\circ\text{C}$	25		45	
			$T_A = \text{full range}$	20			
		$V_{CC} = \pm 5\text{ V}, R_L = 7\ \Omega$	$T_A = +25^\circ\text{C}$	30		55	
			$T_A = \text{full range}$	28			
		$V_{CC} = \pm 15\text{ V}, R_L = 7\ \Omega$	$T_A = +25^\circ\text{C}$	65		85	
			$T_A = \text{full range}$	60			
POWER SUPPLY							
V_{CC}	Supply voltage range	Single supply		5		30	
		Split supply		± 2.5		± 15	
I_{CC}	Quiescent current	$V_{CC} = \pm 5\text{ V}$	$T_A = +25^\circ\text{C}$	12.3		15	
			$T_A = \text{full range}$			16	
		$V_{CC} = \pm 15\text{ V}$	$T_A = +25^\circ\text{C}$	14			
$I_{CC(SD)}$	Quiescent current (shutdown) (THS4130 only) ⁽³⁾	$V = -5\text{ V}$	$T_A = +25^\circ\text{C}$	0.86		1.4	
			$T_A = \text{full range}$			1.5	
PSRR	Power-supply rejection ratio (dc)		$T_A = +25^\circ\text{C}$	73		98	
			$T_A = \text{full range}$	70			

(1) The full range temperature is 0°C to $+70^\circ\text{C}$ for the C-suffix, and -40°C to $+85^\circ\text{C}$ for the I-suffix.

(2) Slew rate is measured from an output level range of 25% to 75%.

(3) For detailed information on the behavior of the power-down circuit, see the [Power-Down Mode](#) section.

7.7 Typical Characteristics: THS413xD, THS413xDGK

at $T_A = 25^\circ\text{C}$, $V_{CC} = \pm 5\text{ V}$, $R_F = 390\ \Omega$, $G = +1\text{ V/V}$, differential input, differential output and $R_L = 800\ \Omega$ (unless otherwise noted)

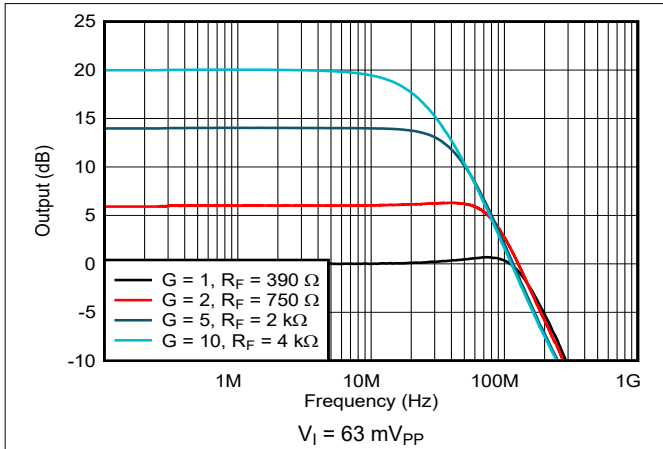

Figure 7-1. Small-Signal Frequency Response

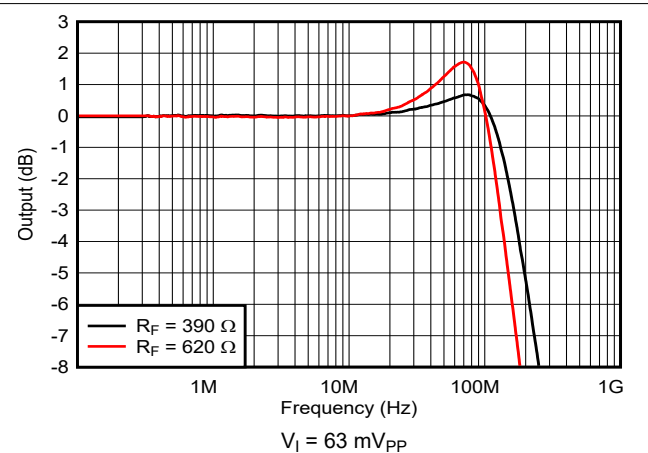

Figure 7-2. Small-Signal Frequency Response

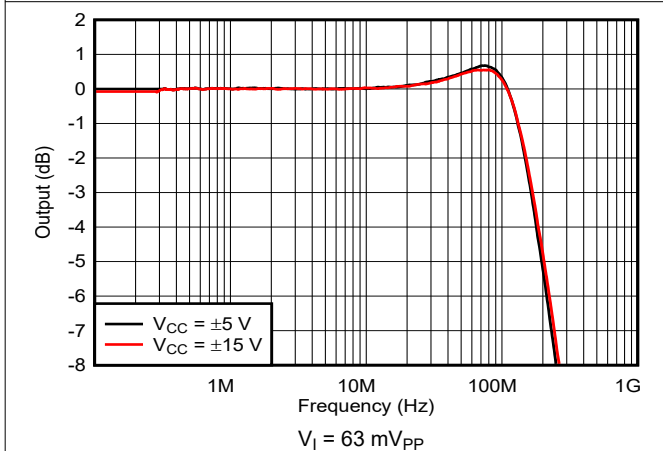

Figure 7-3. Small-Signal Frequency Response

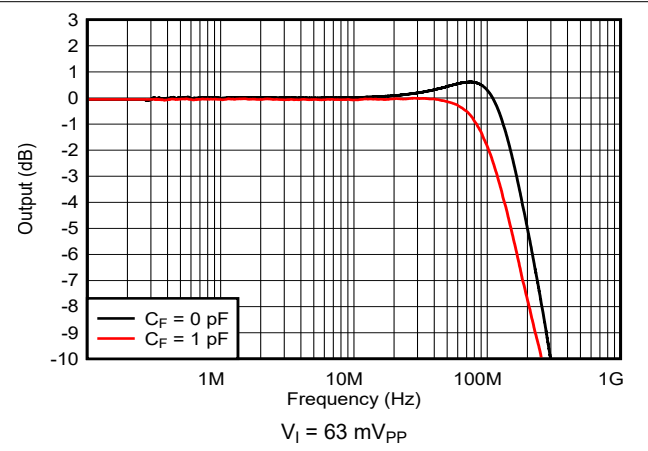

Figure 7-4. Small-Signal Frequency Response

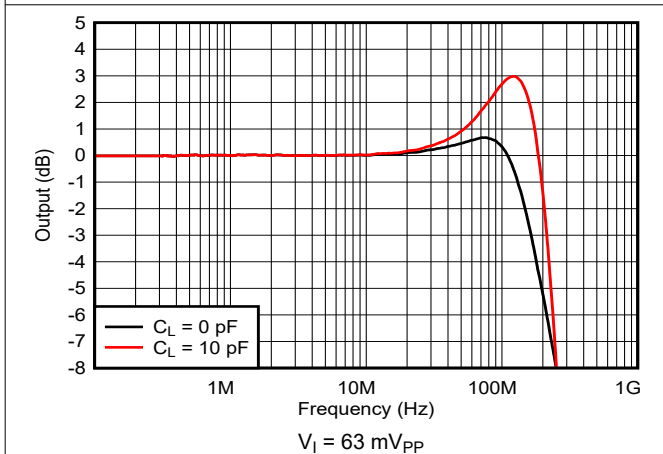

Figure 7-5. Small-Signal Frequency Response

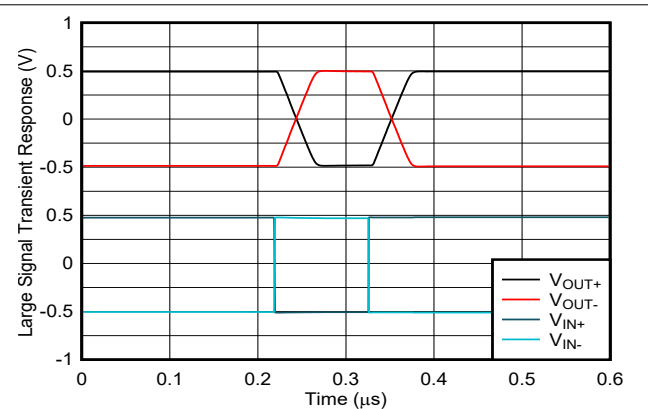

Figure 7-6. Large-Signal Transient Response (Differential In/Single Out)

7.7 Typical Characteristics: THS413xD, THS413xDGK (continued)

at $T_A = 25^\circ\text{C}$, $V_{CC} = \pm 5\text{ V}$, $R_F = 390\ \Omega$, $G = +1\text{ V/V}$, differential input, differential output and $R_L = 800\ \Omega$ (unless otherwise noted)

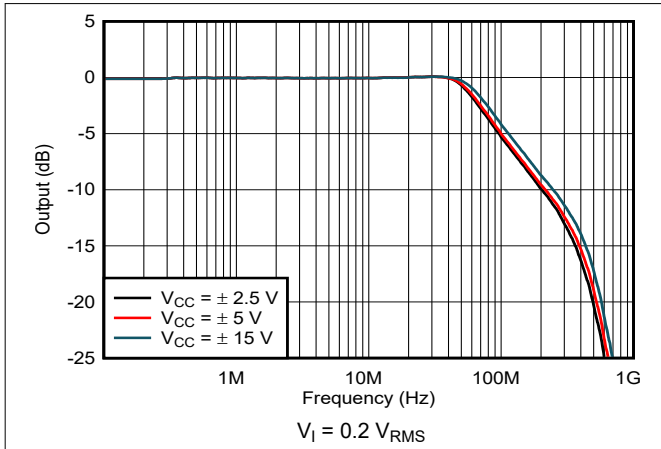

Figure 7-7. Large-Signal Frequency Response

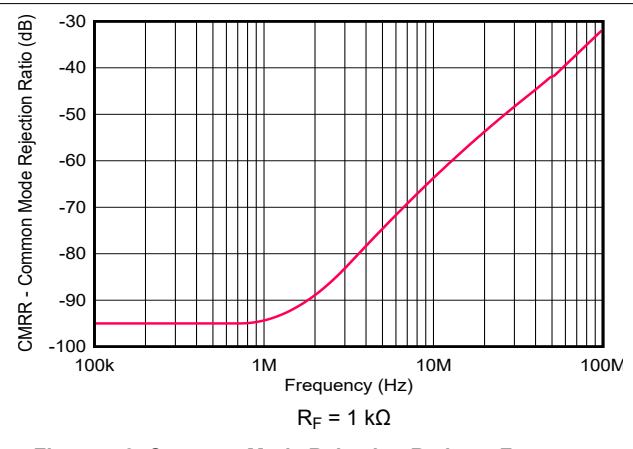

Figure 7-8. Common-Mode Rejection Ratio vs Frequency

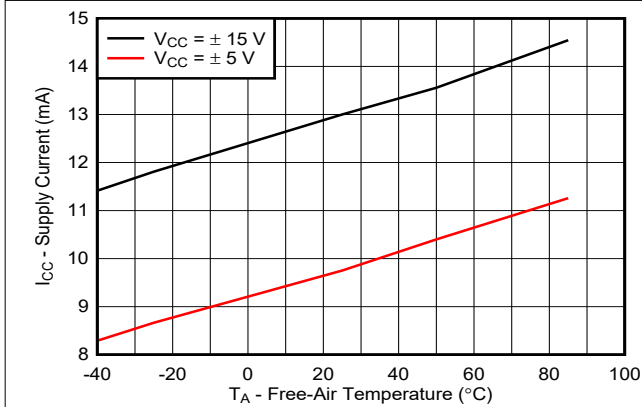

Figure 7-9. Supply Current vs Free-Air Temperature

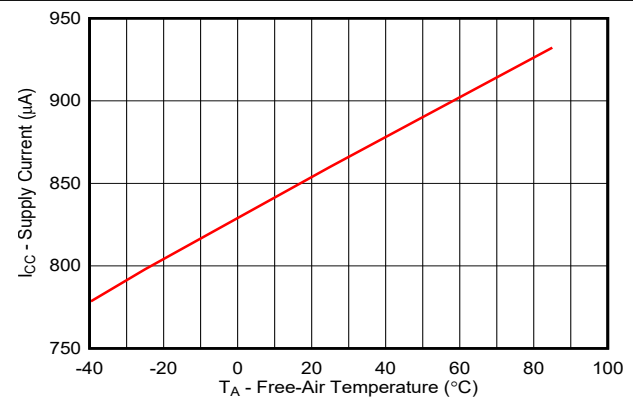

Figure 7-10. Supply Current vs Free-Air Temperature (Shutdown State)

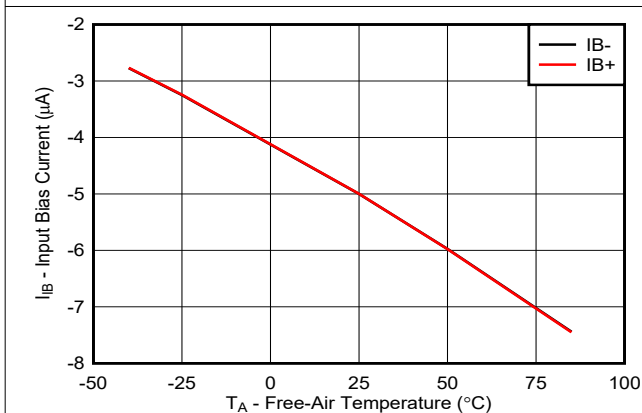

Figure 7-11. Input Bias Current vs Free-Air Temperature

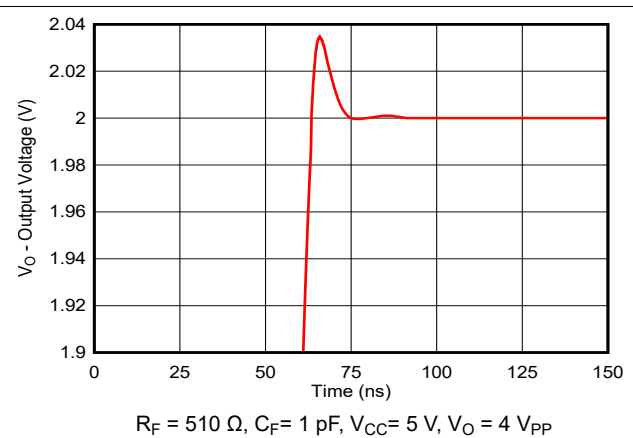

Figure 7-12. Settling Time

7.7 Typical Characteristics: THS413xD, THS413xDGK (continued)

at $T_A = 25^\circ\text{C}$, $V_{CC} = \pm 5\text{ V}$, $R_F = 390\ \Omega$, $G = +1\text{ V/V}$, differential input, differential output and $R_L = 800\ \Omega$ (unless otherwise noted)

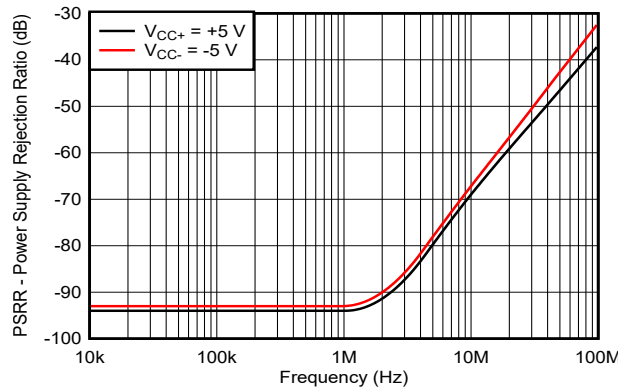

Figure 7-13. Power-Supply Rejection Ratio vs Frequency (Differential Out)

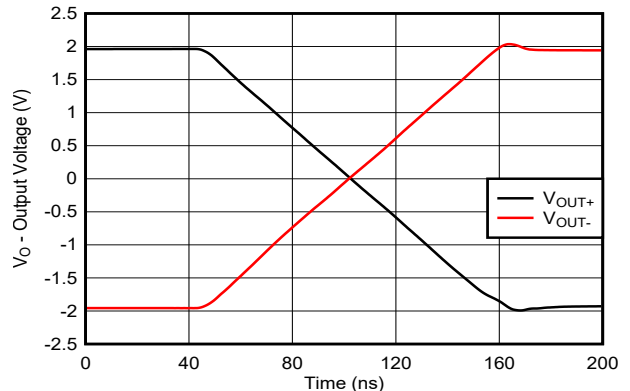

Figure 7-14. Large-Signal Transient Response

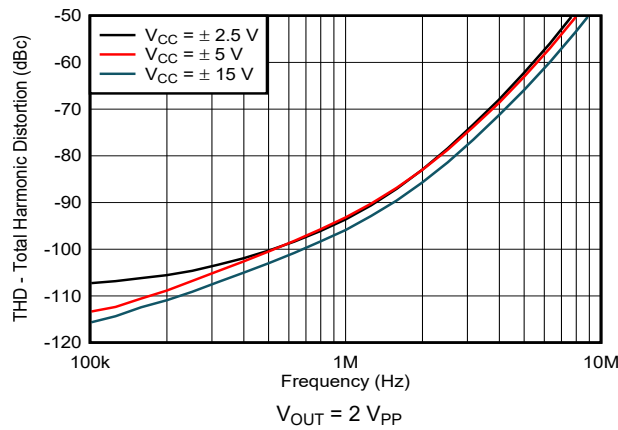

Figure 7-15. Total Harmonic Distortion vs Frequency

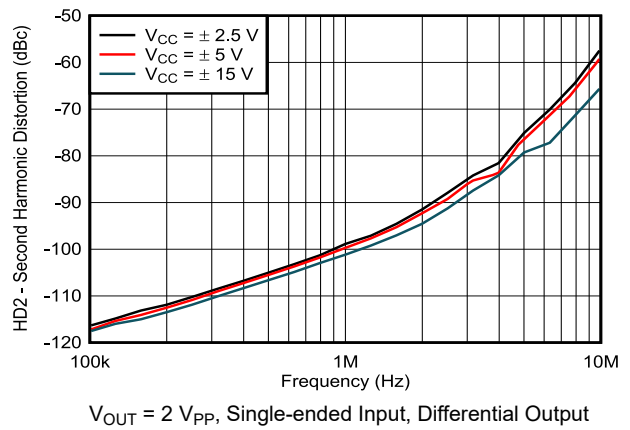

Figure 7-16. Second-Harmonic Distortion vs Frequency

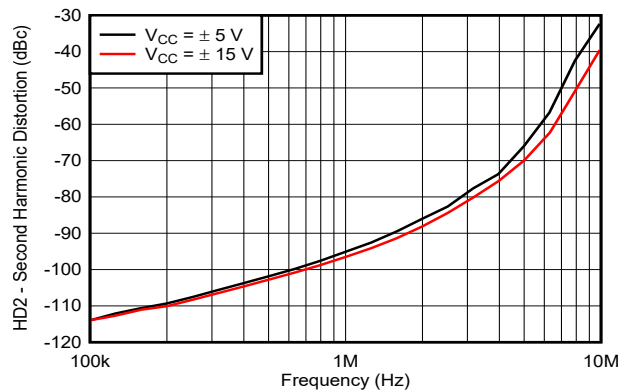

Figure 7-17. Second-Harmonic Distortion vs Frequency

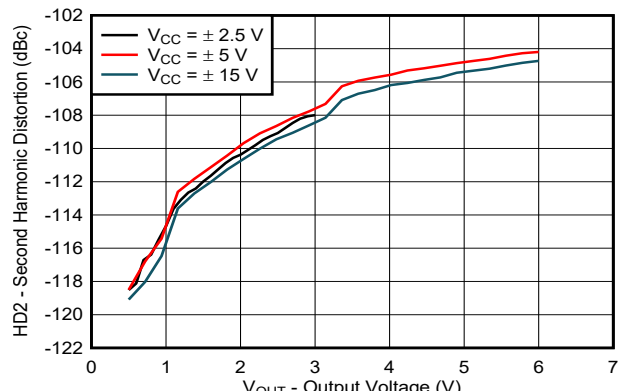
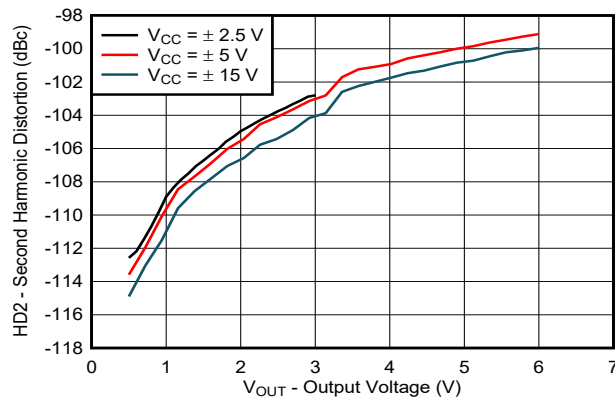

Figure 7-18. Second-Harmonic Distortion vs Output Voltage

7.7 Typical Characteristics: THS413xD, THS413xDGK (continued)

at $T_A = 25^\circ\text{C}$, $V_{CC} = \pm 5\text{ V}$, $R_F = 390\ \Omega$, $G = +1\text{ V/V}$, differential input, differential output and $R_L = 800\ \Omega$ (unless otherwise noted)



$f = 500\text{ kHz}$, Single-ended Input, Differential Output

Figure 7-19. Second-Harmonic Distortion vs Output Voltage

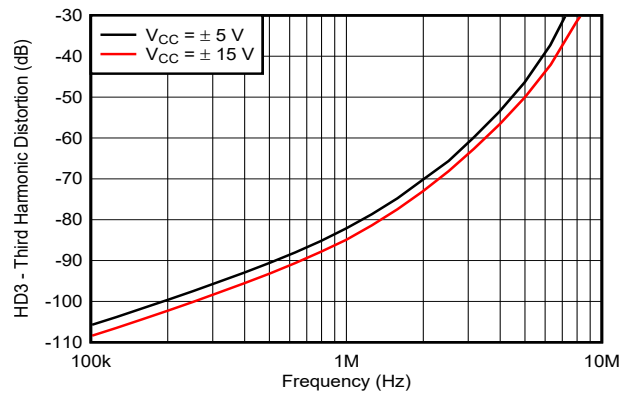

$V_{OUT} = 4\text{ V}_{PP}$, Single-ended Input, Differential Output

Figure 7-20. Third-Harmonic Distortion vs Frequency

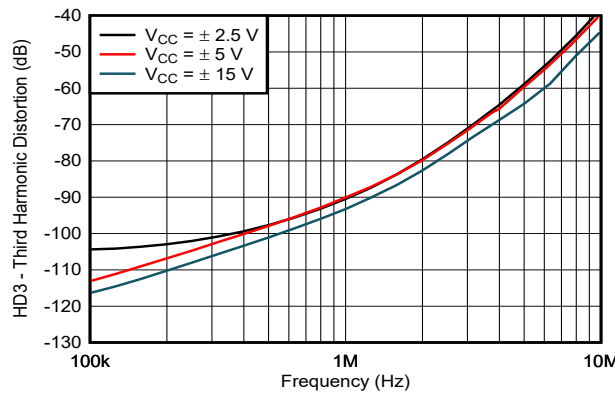

$V_{OUT} = 2\text{ V}_{PP}$, Single-ended Input, Differential Output

Figure 7-21. Third-Harmonic Distortion vs Frequency

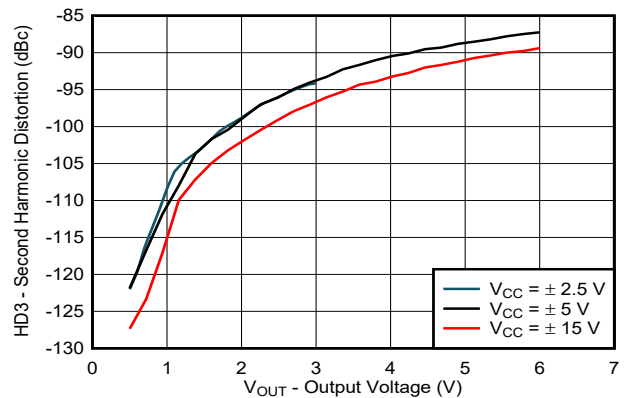

$f = 500\text{ kHz}$, Single-ended Input, Differential Output

Figure 7-22. Third-Harmonic Distortion vs Output Voltage

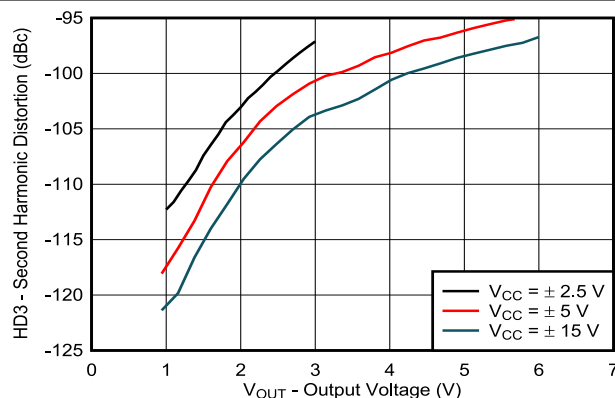

$f = 250\text{ kHz}$, Single-ended Input, Differential Output

Figure 7-23. Third-Harmonic Distortion vs Output Voltage

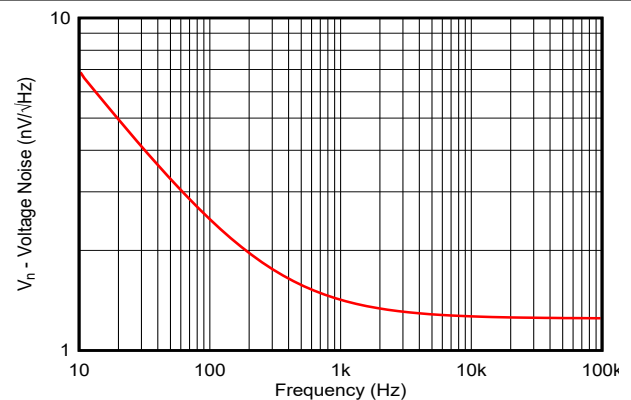
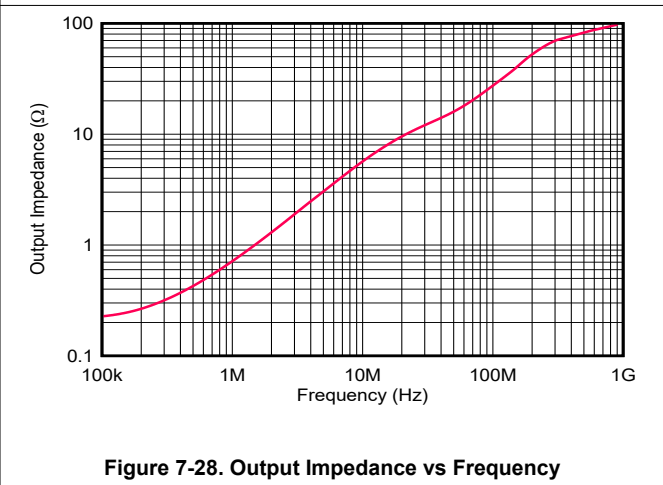
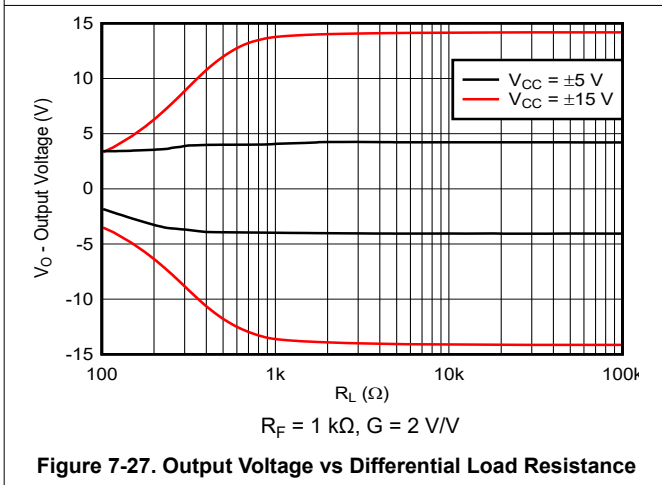
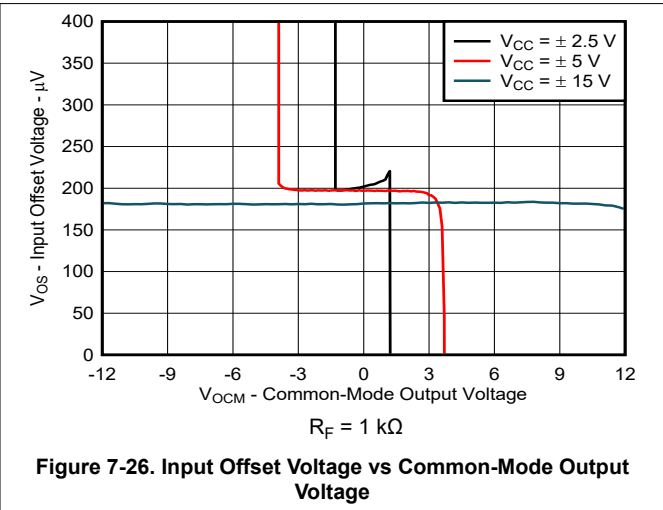
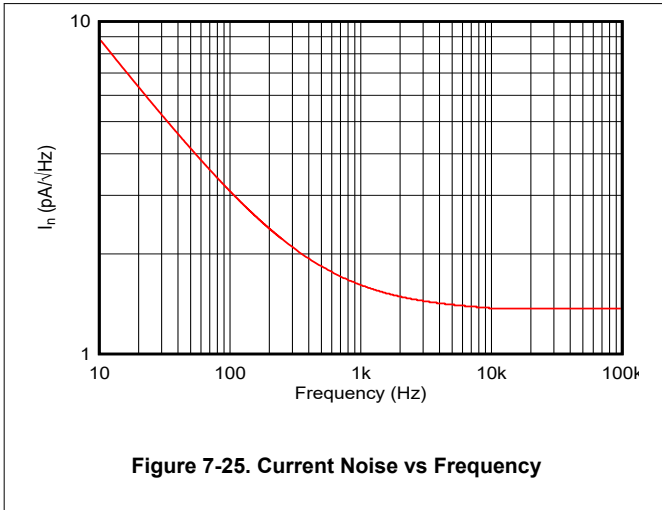

Figure 7-24. Voltage Noise vs Frequency

7.7 Typical Characteristics: THS413xD, THS413xDGK (continued)

at $T_A = 25^\circ\text{C}$, $V_{CC} = \pm 5\text{ V}$, $R_F = 390\ \Omega$, $G = +1\text{ V/V}$, differential input, differential output and $R_L = 800\ \Omega$ (unless otherwise noted)



7.8 Typical Characteristics: THS413xDGN

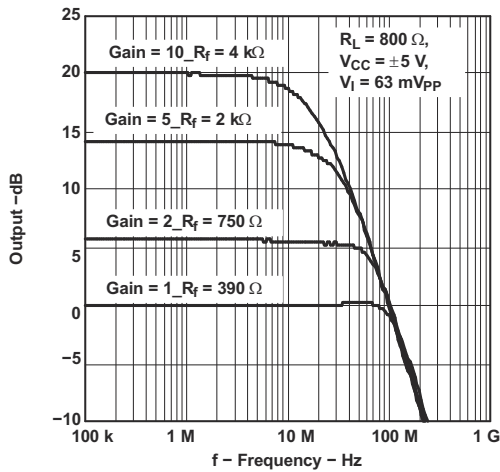

Figure 7-29. Small-Signal Frequency Response

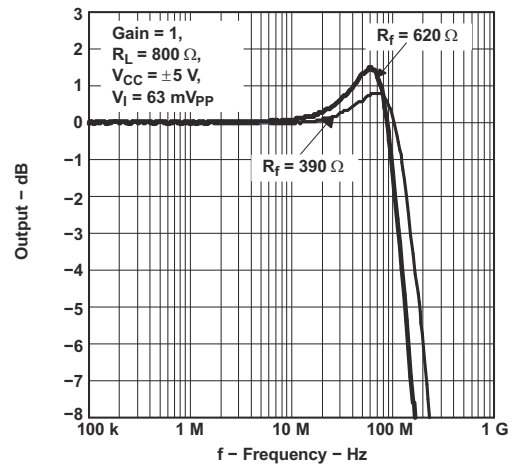

Figure 7-30. Small-Signal Frequency Response

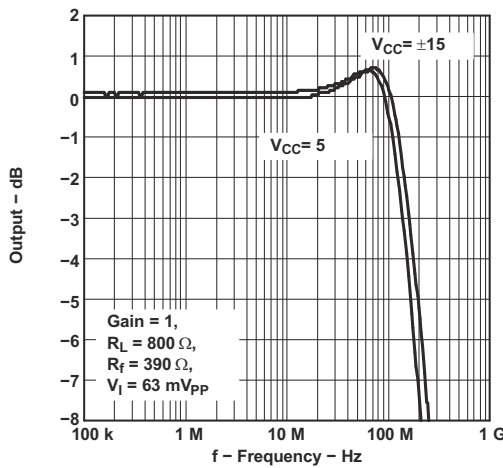

Figure 7-31. Small-Signal Frequency Response (Various Supplies)

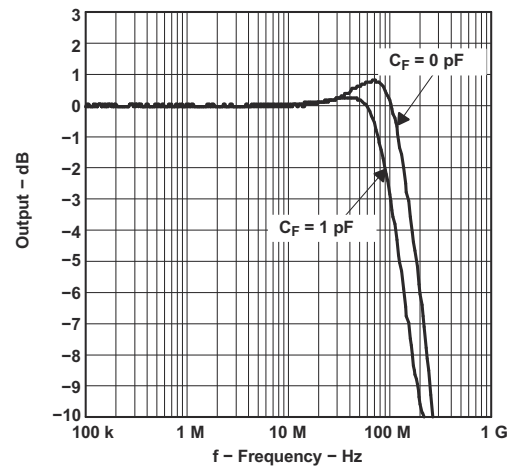

Figure 7-32. Small-Signal Frequency Response (Various C_F)

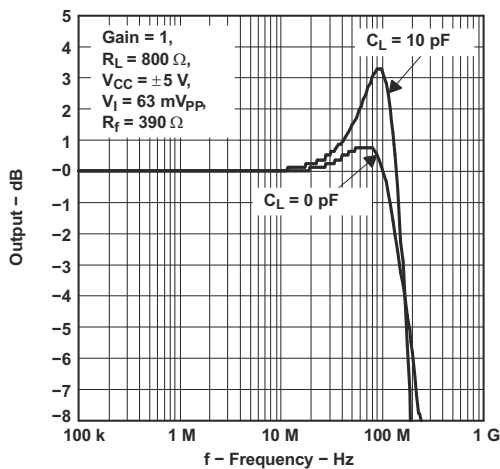

Figure 7-33. Small-Signal Frequency Response (Various C_L)

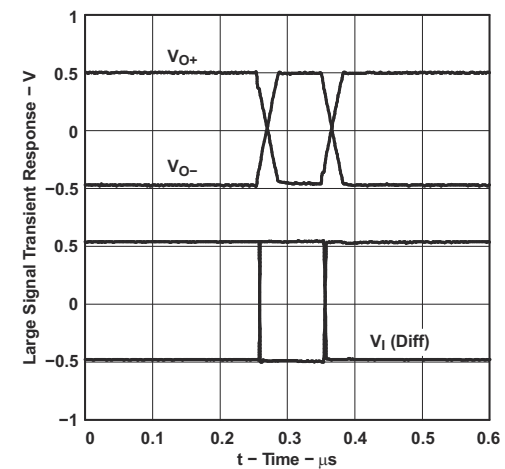

Figure 7-34. Large-Signal Transient Response (Differential In/Single Out)

7.8 Typical Characteristics: THS413xDGN (continued)

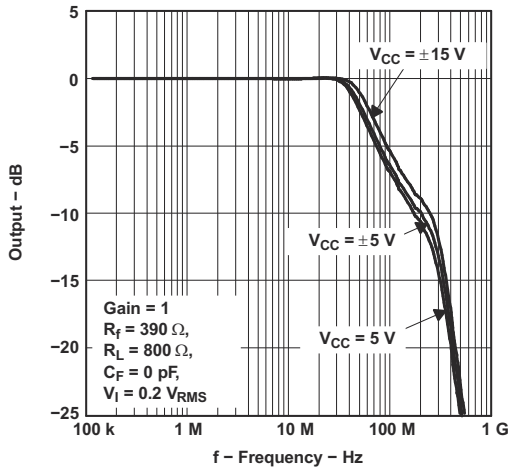

Figure 7-35. Large-Signal Frequency Response

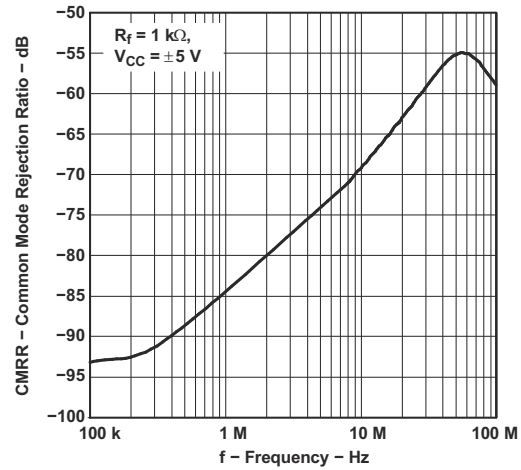

Figure 7-36. Common-Mode Rejection Ratio vs Frequency

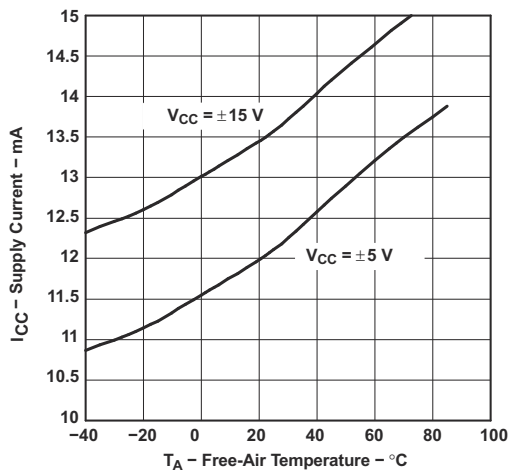

Figure 7-37. Supply Current vs Free-Air Temperature

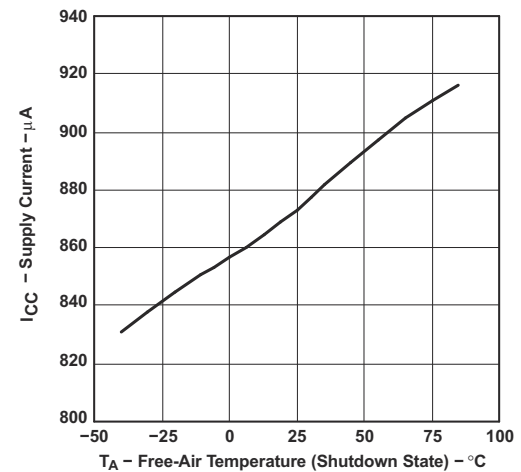

Figure 7-38. Supply Current vs Free-Air Temperature (Shutdown State)

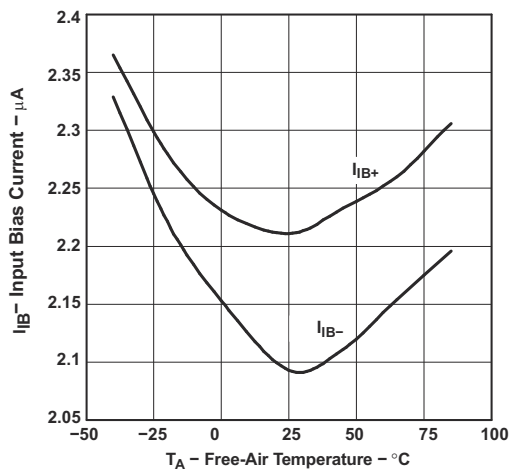

Figure 7-39. Input Bias Current vs Free-Air Temperature

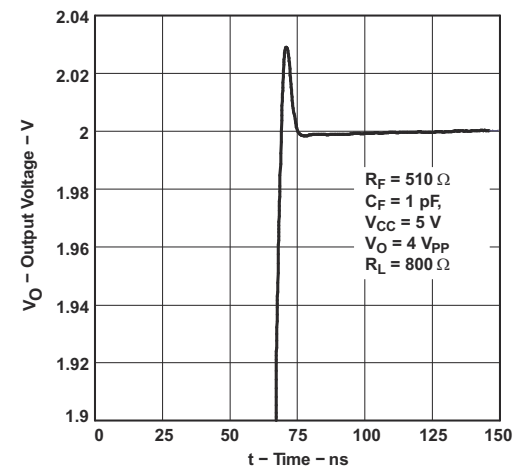

Figure 7-40. Settling Time

7.8 Typical Characteristics: THS413xDGN (continued)

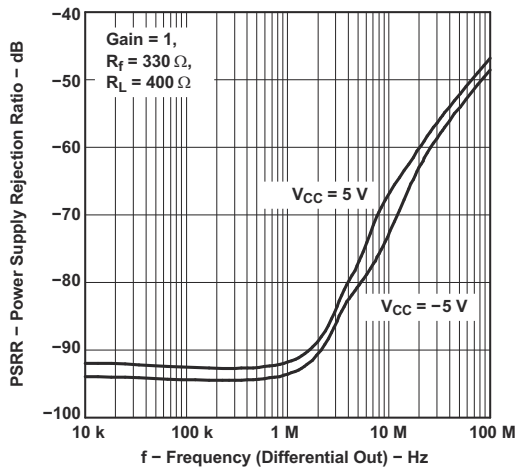

Figure 7-41. Power-Supply Rejection Ratio vs Frequency (Differential Out)

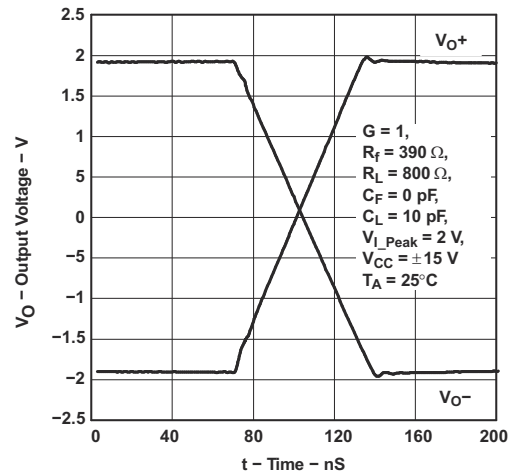

Figure 7-42. Large-Signal Transient Response

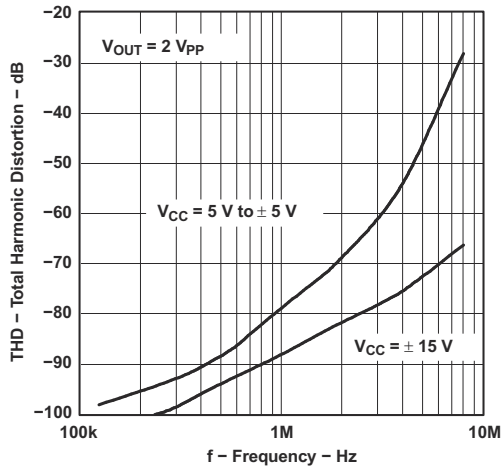

Figure 7-43. Total Harmonic Distortion vs Frequency

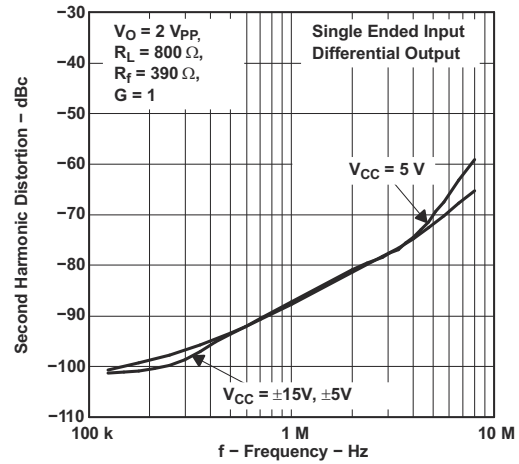

Figure 7-44. Second-Harmonic Distortion vs Frequency

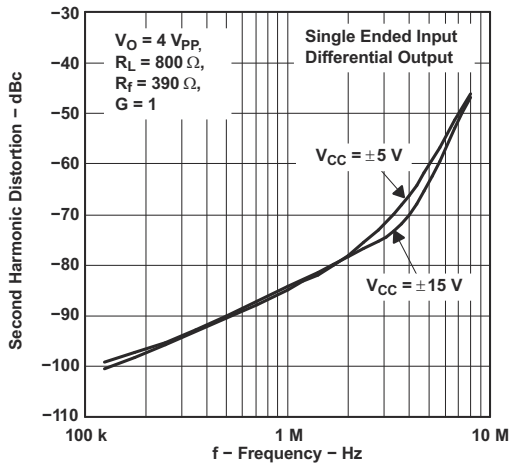

Figure 7-45. Second-Harmonic Distortion vs Frequency

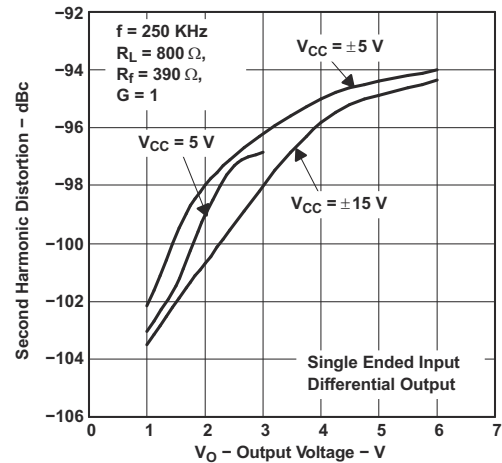

Figure 7-46. Second-Harmonic Distortion vs Output Voltage

7.8 Typical Characteristics: THS413xDGN (continued)

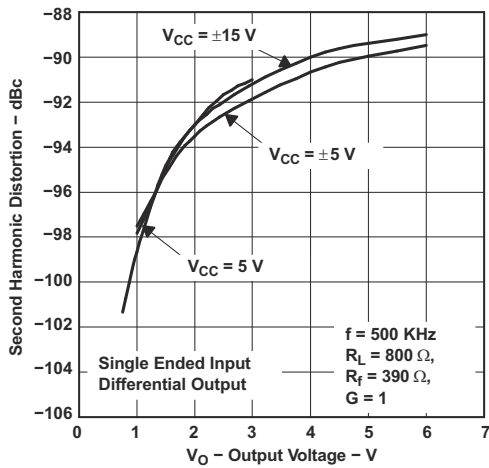

Figure 7-47. Second-Harmonic Distortion vs Output Voltage

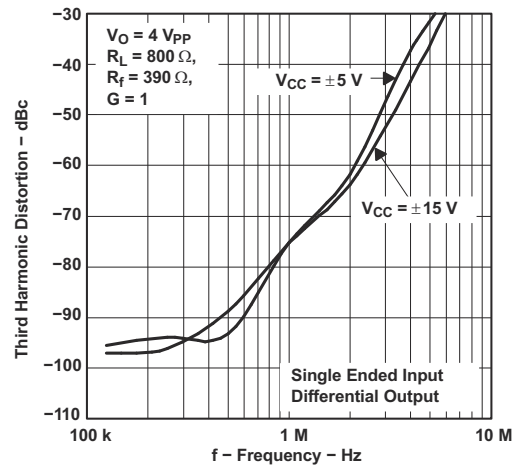

Figure 7-48. Third-Harmonic Distortion vs Frequency

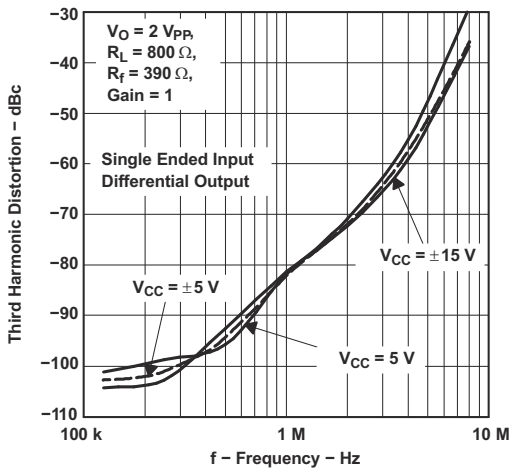

Figure 7-49. Third-Harmonic Distortion vs Frequency

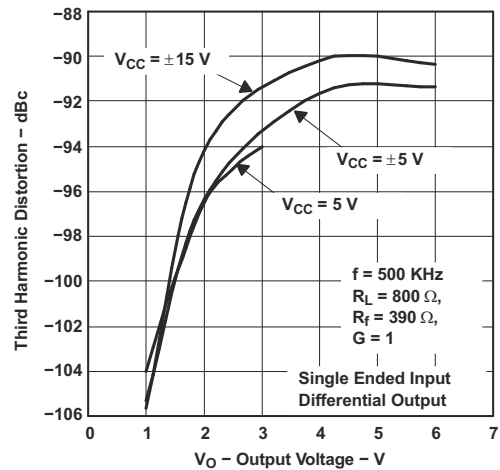

Figure 7-50. Third-Harmonic Distortion vs Output Voltage

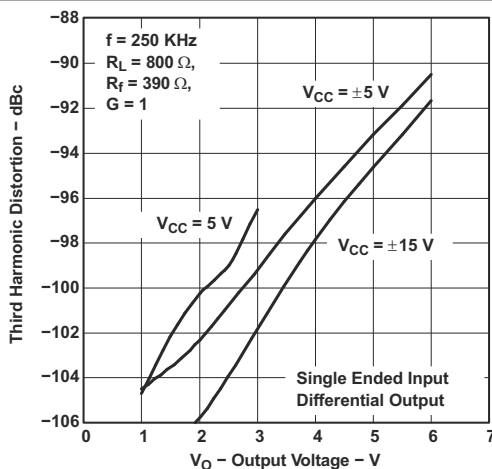

Figure 7-51. Third-Harmonic Distortion vs Output Voltage

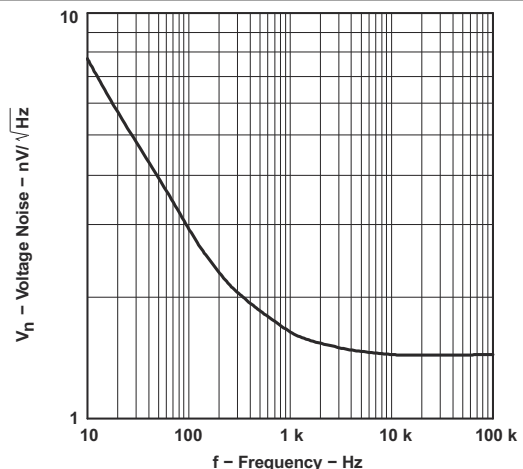

Figure 7-52. Voltage Noise vs Frequency

7.8 Typical Characteristics: THS413xDGN (continued)

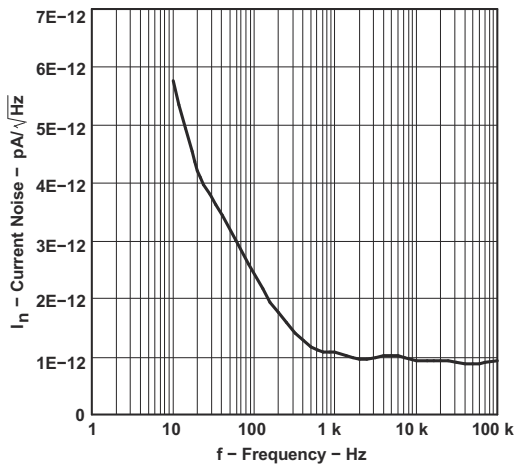

Figure 7-53. Current Noise vs Frequency

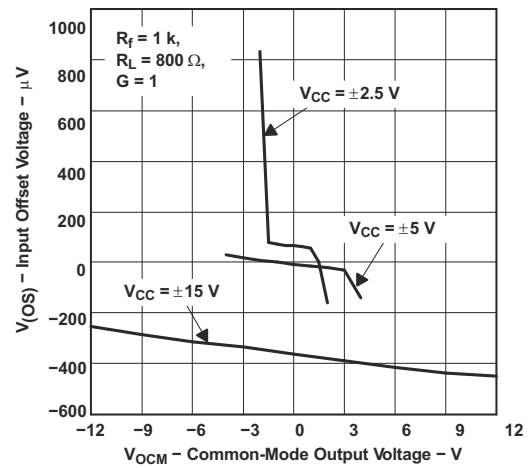

Figure 7-54. Input Offset Voltage vs Common-Mode Output Voltage

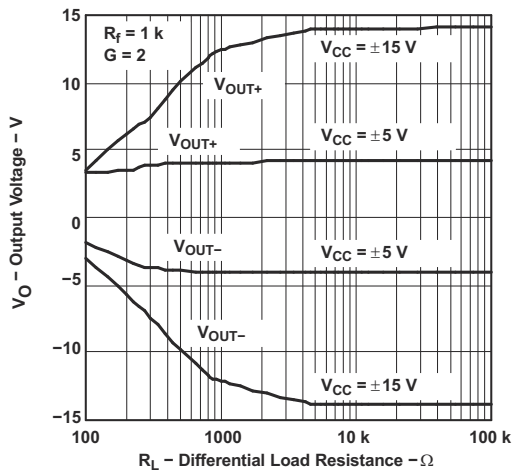

Figure 7-55. Output Voltage vs Differential Load Resistance

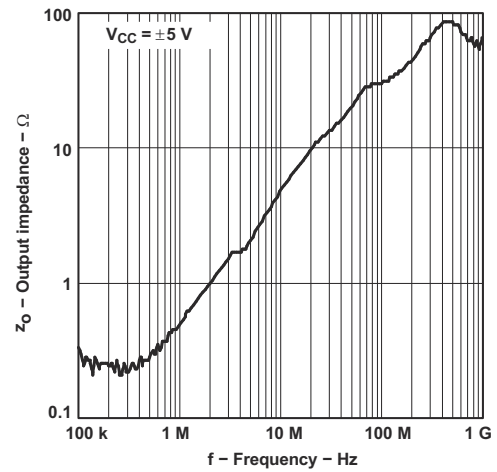

Figure 7-56. Output Impedance vs Frequency

8 Detailed Description

8.1 Overview

8.1.1 Fully-Differential Amplifiers

The THS413x is a fully differential amplifier (FDA). Differential signal processing offers a number of performance advantages in high-speed analog signal processing systems, including immunity to external common-mode noise, suppression of even-order non-linearities, and increased dynamic range. FDAs not only serve as the primary means of providing gain to a differential signal chain, but also provide a monolithic solution for converting single-ended signals into differential signals allowing for easy, high-performance processing. For more information on the basic theory of operation for FDAs, refer to the [Fully Differential Amplifiers application note](#).

8.2 Functional Block Diagram

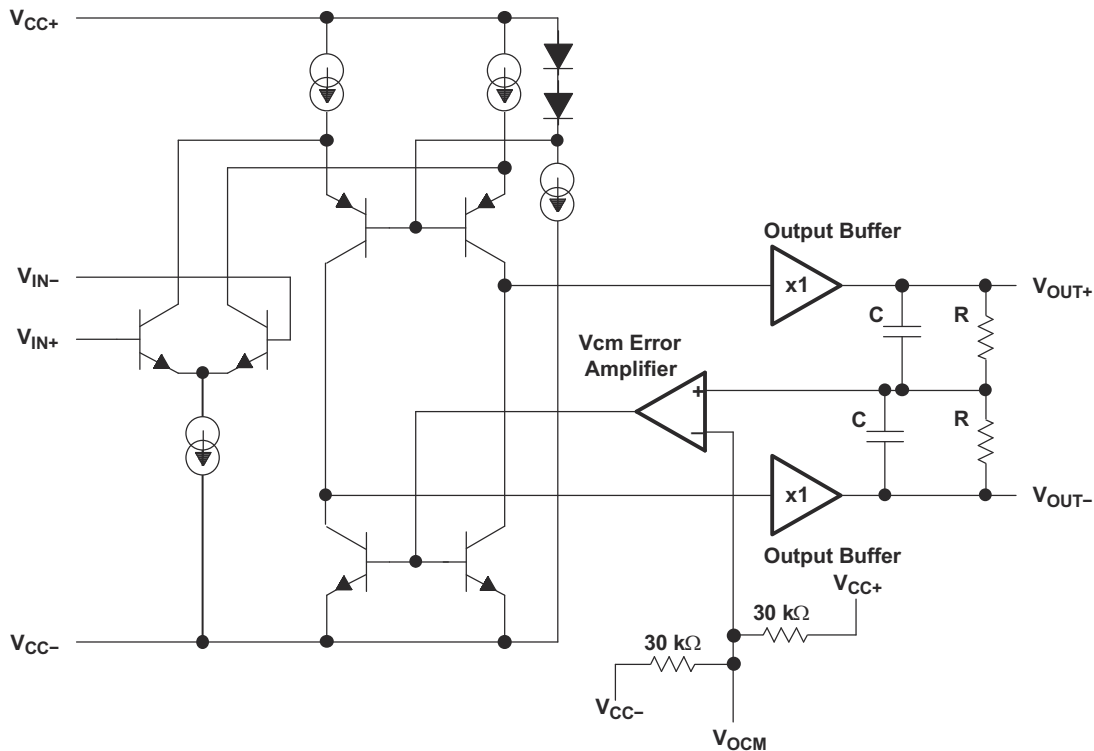

8.3 Feature Description

Figure 8-1 and Figure 8-2 depict the differences between the operation of the THS413x in two different modes. FDAs can work with either differential or single-ended inputs.

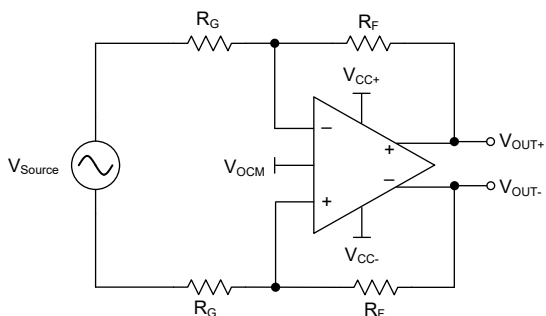

Figure 8-1. Amplifying Differential Input Signals

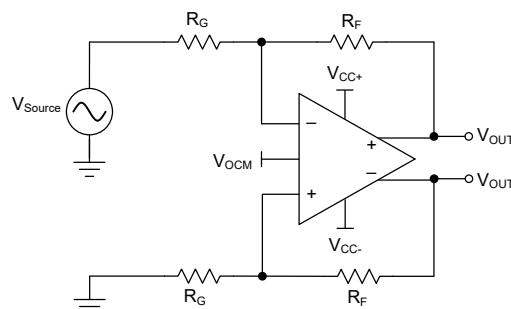

Figure 8-2. Amplifying Single-ended Input Signals

8.4 Device Functional Modes

8.4.1 Power-Down Mode

The Power-Down mode is used when power saving is required. The power-down terminal (\overline{PD}) found on the THS4130 is an active low input. If left unconnected, an internal 250 k Ω resistor to V_{CC+} keeps the device turned on. The threshold voltage for the power-down function is approximately 1.4 V above V_{CC-} . This means that if the \overline{PD} terminal is 1.4 V above V_{CC-} , then the device is active. If the \overline{PD} terminal is less than 1.4 V above V_{CC-} , then the device is off. It is recommended to pull the terminal to V_{CC-} to turn the device off. Figure 8-3 shows the simplified version of the power-down circuit. While in the Power-Down mode, the amplifier goes into a high-impedance state. The amplifier's output impedance is typically greater than 1 M Ω in the Power-Down mode.

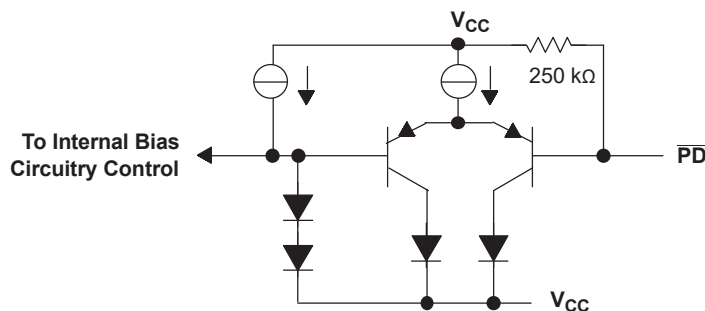

Figure 8-3. Simplified Power-Down Circuit

Similar to an opamp in an inverting configuration, the output impedance of an FDA is determined by its feedback network configuration. In addition, the THS4130 has an internal 10 k Ω resistor at each output that is tied to the V_{CM} error amplifier (see Section 8.2). The differential output impedance is equal to $[(2 \cdot R_F + 2 \cdot R_G) \parallel 20 \text{ k}\Omega]$. Figure 8-4 shows the closed loop output impedance of the THS4130 when in power-down.

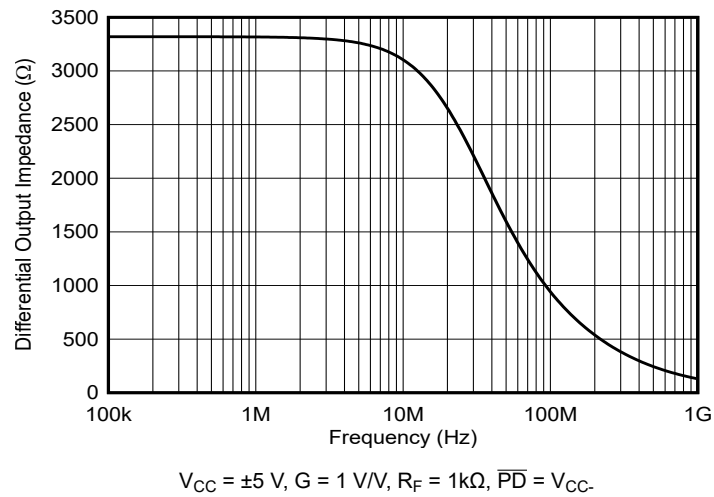

Figure 8-4. Output Impedance (in Power-Down) vs Frequency

9 Application and Implementation

Note

Information in the following applications sections is not part of the TI component specification, and TI does not warrant its accuracy or completeness. TI's customers are responsible for determining suitability of components for their purposes, as well as validating and testing their design implementation to confirm system functionality.

9.1 Application Information

9.1.1 Output Common-Mode Voltage

The output common-mode voltage pin sets the dc output voltage of the THS413x. A voltage applied to the V_{OCM} pin from a low-impedance source can be used to directly set the output common-mode voltage. If the V_{OCM} pin is left floating, then it defaults to the mid-rail voltage, defined as:

$$\frac{(V_{CC+}) + (V_{CC-})}{2} \quad (1)$$

To minimize common-mode noise, connect a 0.1- μ F bypass capacitor to the V_{OCM} pin. Output common-mode voltage causes additional current to flow in the feedback resistor network. Since this current is supplied by the output stage of the amplifier, this creates additional power dissipation. For commonly-used feedback resistance values, this current is easily supplied by the amplifier. The additional internal power dissipation created by this current may be significant in some applications and may dictate use of the MSOP PowerPAD package to effectively control self-heating.

9.1.1.1 Resistor Matching

Resistor matching is important in FDAs to maintain good output balance. An ideal differential output signal implies the two outputs of the FDA should be exactly equal in amplitude and shifted 180° in phase. Any imbalance in amplitude or phase between the two output signals results in an undesirable common-mode signal at the output. The output balance error is a measure of how well the outputs are balanced and is defined as the ratio of the output common-mode voltage to the output differential signal.

$$\text{Output Balance Error} = \frac{\left(\frac{V_{OUT+} - V_{OUT-}}{2}\right)}{V_{OUT+} - V_{OUT-}} \quad (2)$$

At low frequencies, resistor mismatch is the primary contributor to output balance errors. Additionally CMRR, PSRR, and HD2 performance diminish if resistor mismatch occurs. Therefore, it is recommended to use 1% tolerance resistors or better to optimize performance. [Table 9-1](#) provides the recommended resistor values to use for a particular gain.

Table 9-1. Recommended Resistor Values

Gain (V/V)	R_G (Ω)	R_F (Ω)
1	390	390
2	374	750
5	402	2010
10	402	4020

9.1.2 Driving a Capacitive Load

Driving capacitive loads with high-performance amplifiers is not a problem as long as certain precautions are taken. The THS413x has been internally compensated to maximize its bandwidth and slew rate performance. When the amplifier is compensated in this manner, capacitive loading directly on the output decreases the device phase margin leading to high-frequency ringing or oscillations. Therefore, for capacitive loads of greater than 10 pF, it is recommended that a resistor be placed in series with the output of the amplifier, as shown in Figure 9-1. A minimum value of 20 Ω should work well for most applications. For example, in 50-Ω transmission systems, setting the series resistor value to 50 Ω both isolates any capacitance loading and provides the proper line impedance matching at the source end.

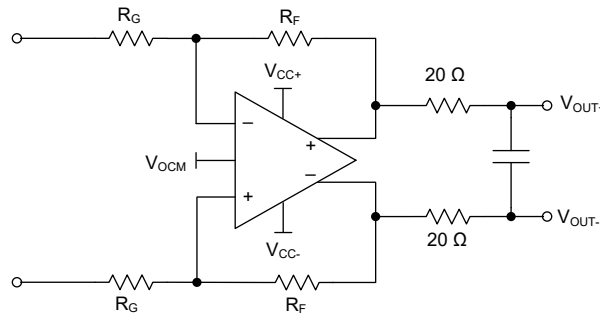

Figure 9-1. Driving a Capacitive Load

9.1.3 Data Converters

Driving data converters are one of the most popular applications for fully-differential amplifiers. Figure 9-2 shows a typical configuration of an FDA attached to a differential analog-to-digital converter (ADC).

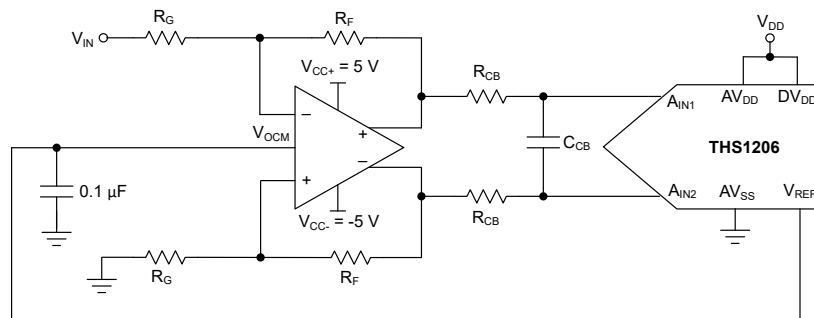

Figure 9-2. Fully-Differential Amplifier Attached to a Differential ADC

FDAs can operate with a single supply. V_{OCM} defaults to the mid-rail voltage, $V_{CC}/2$. The differential output may be fed into a data converter. This method eliminates the use of a transformer in the circuit. If the ADC has a reference voltage output (V_{ref}), then it is recommended to connect it directly to the V_{OCM} of the amplifier using a bypass capacitor to reduce broadband common-mode noise.

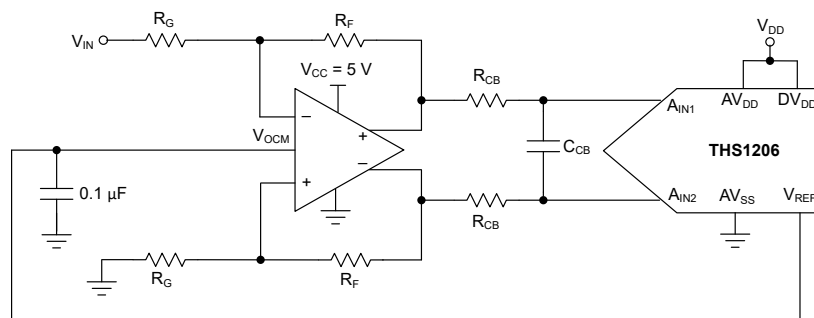

Figure 9-3. Fully-Differential Amplifier Using a Single Supply

9.1.4 Single-Supply Applications

For proper operation, the input common-mode voltage to the input terminal of the amplifier should not exceed the common-mode input voltage range. However, some single-supply applications may require the input voltage to exceed the common-mode input voltage range. In such cases, the circuit configuration of Figure 9-4 is suggested to bring the common-mode input voltage within the specifications of the amplifier.

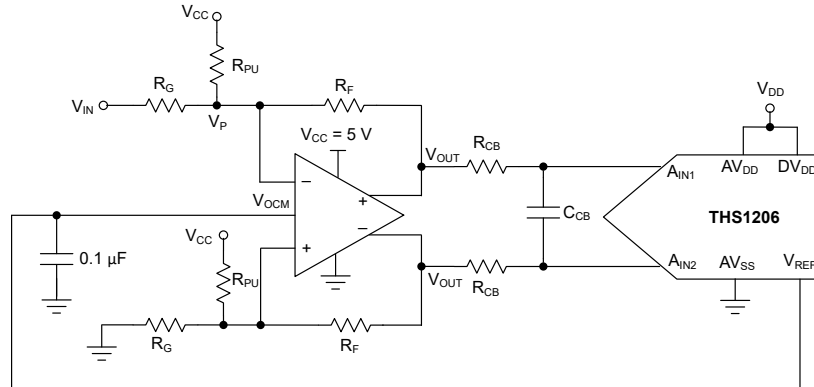

Figure 9-4. Circuit With Improved Common-Mode Input Voltage

Equation 3 is used to calculate R_{PU} :

$$R_{PU} = \frac{V_P - V_{CC}}{(V_{IN} - V_P) \frac{1}{R_G} + (V_{OUT} - V_P) \frac{1}{R_F}} \quad (3)$$

9.2 Typical Application

For signal conditioning in ADC applications, it is important to limit the input frequency to the ADC. Low-pass filters can prevent the aliasing of the high-frequency noise with the frequency of operation. Figure 9-5 shows a method by which the noise may be filtered in the THS413x.

Figure 9-5 shows a typical application design example for the THS413x device in active low-pass filter topology driving and ADC.

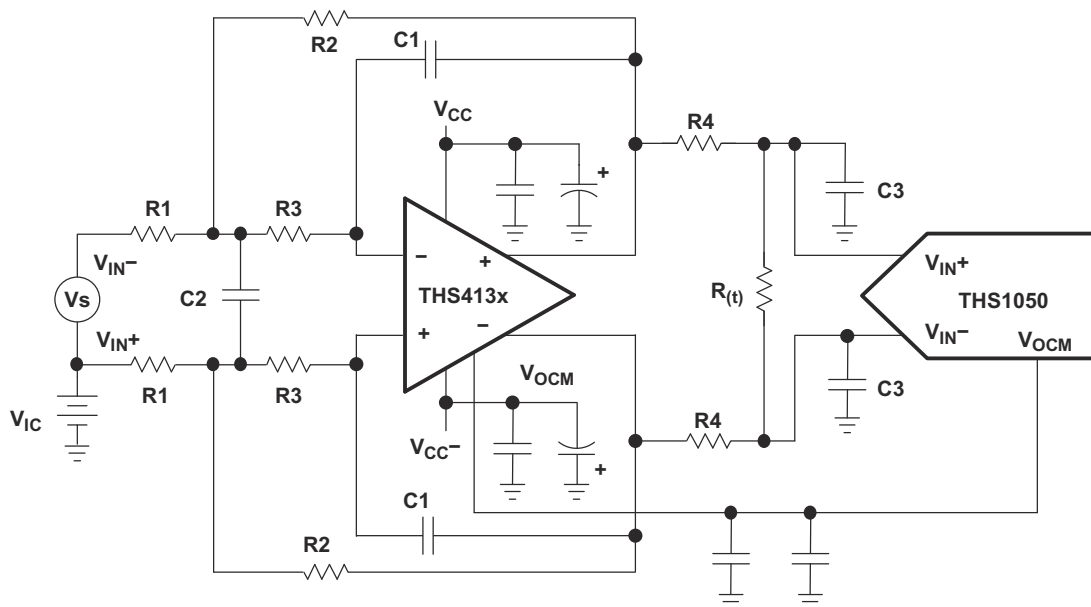

Figure 9-5. Antialias Filtering

9.2.1 Design Requirements

Table 9-2 shows example design parameters and values for the typical application design example in Figure 9-5.

Table 9-2. Design Parameters

DESIGN PARAMETERS	VALUE
Supply voltage	±2.5 V to ±15 V
Amplifier topology	Voltage feedback
Output control	DC coupled with output common mode control capability
Filter requirement	500 kHz, Multiple feedback low pass filter

9.2.2 Detailed Design Procedure

9.2.2.1 Active Antialias Filtering

Figure 9-5 shows a multiple-feedback (MFB) lowpass filter. The transfer function for this filter circuit is:

$$H_d(f) = \left(\frac{K}{-\left(\frac{f}{\text{FSF} \times f_c}\right)^2 + \frac{1}{Q} \frac{jf}{\text{FSF} \times f_c} + 1} \right) \times \left(\frac{\frac{R_t}{2R_4 + R_t}}{1 + \frac{j2\pi f R_4 R_t C_3}{2R_4 + R_t}} \right) \text{ Where } K = \frac{R_2}{R_1} \quad (4)$$

$$\text{FSF} \times f_c = \frac{1}{2\pi\sqrt{2 \times R_2 R_3 C_1 C_2}} \text{ and } Q = \frac{\sqrt{2 \times R_2 R_3 C_1 C_2}}{R_3 C_1 + R_2 C_1 + K R_3 C_1} \quad (5)$$

K sets the pass band gain, f_c is the cutoff frequency for the filter, FSF is a frequency scaling factor, and Q is the quality factor.

$$\text{FSF} = \sqrt{\text{Re}^2 + |\text{Im}|^2} \text{ and } Q = \frac{\sqrt{\text{Re}^2 + |\text{Im}|^2}}{2\text{Re}} \quad (6)$$

where Re is the real part, and Im is the imaginary part of the complex pole pair. Setting $R_2 = R$, $R_3 = mR$, $C_1 = C$, and $C_2 = nC$ results in:

$$\text{FSF} \times f_c = \frac{1}{2\pi RC\sqrt{2 \times mn}} \text{ and } Q = \frac{\sqrt{2 \times mn}}{1 + m(1 + K)} \quad (7)$$

Start by determining the ratios, m and n, required for the gain and Q of the filter type being designed, then select C and calculate R for the desired f_c .

9.2.3 Application Curve

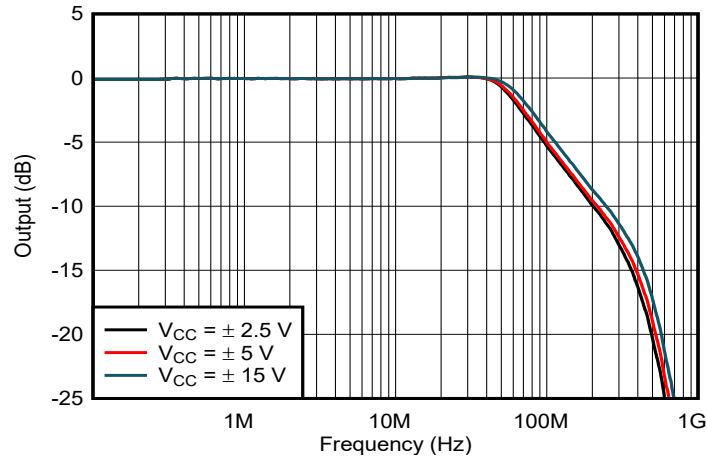

Figure 9-6. Large-Signal Frequency Response

10 Power Supply Recommendations

The THS413x device was designed to operate on power supplies ranging from $\pm 2.5\text{ V}$ to $\pm 15\text{ V}$ (single-ended supplies of 5 V to 30 V). TI recommends using a power-supply accuracy of 5% or better. When operated on a board with high-speed digital signals, it is important to provide isolation between digital signal noise and the analog input pins. The THS413x is connected to power supplies through pin 3 (V_{CC+}) and pin 6 (V_{CC-}). Each supply pin should be decoupled to GND as close to the device as possible with a low-inductance, surface-mount ceramic capacitor of approximately 10 nF. When vias are used to connect the bypass capacitors to a ground plane the vias should be configured for minimal parasitic inductance. One method of reducing via inductance is to use multiple vias. For broadband systems, two capacitors per supply pin are advised.

To avoid undesirable signal transients, the THS413x device should not be powered on with large inputs signals present. Careful planning of system power on sequencing is especially important to avoid damage to ADC inputs when an ADC is used in the application.

11 Layout

11.1 Layout Guidelines

To achieve the levels of high-frequency performance of the THS413x device, follow proper printed-circuit board (PCB) high-frequency design techniques. The following is a general set of guidelines. In addition, a THS413x device evaluation board is available to use as a guide for layout or for evaluating the device performance.

- Ground planes—it is highly recommended that a ground plane be used on the board to provide all components with a low inductive ground connection. However, in the areas of the amplifier inputs and output, the ground plane can be removed to minimize the stray capacitance.
- Proper power-supply decoupling—use a 6.8- μF tantalum capacitor in parallel with a 0.1- μF ceramic capacitor on each supply terminal. It may be possible to share the tantalum among several amplifiers depending on the application, but a 0.1- μF ceramic capacitor should always be used on the supply terminal of every amplifier. In addition, the 0.1- μF capacitor should be placed as close as possible to the supply terminal. As this distance increases, the inductance in the connecting trace makes the capacitor less effective. The designer should strive for distances of less than 0.1 inches between the device power terminals and the ceramic capacitors.
- Short trace runs or compact part placements—optimum high-frequency performance is achieved when stray series inductance has been minimized. To realize this, the circuit layout should be made as compact as possible, thereby minimizing the length of all trace runs. Particular attention should be paid to the inputs of the amplifier. Its length should be kept as short as possible. This helps to minimize stray capacitance at the input of the amplifier.

11.2 Layout Example

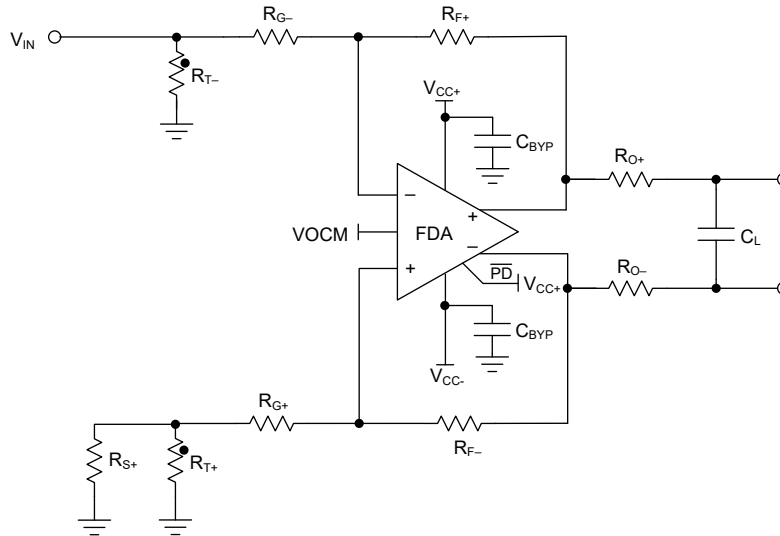

Figure 11-1. Representative Schematic for Layout

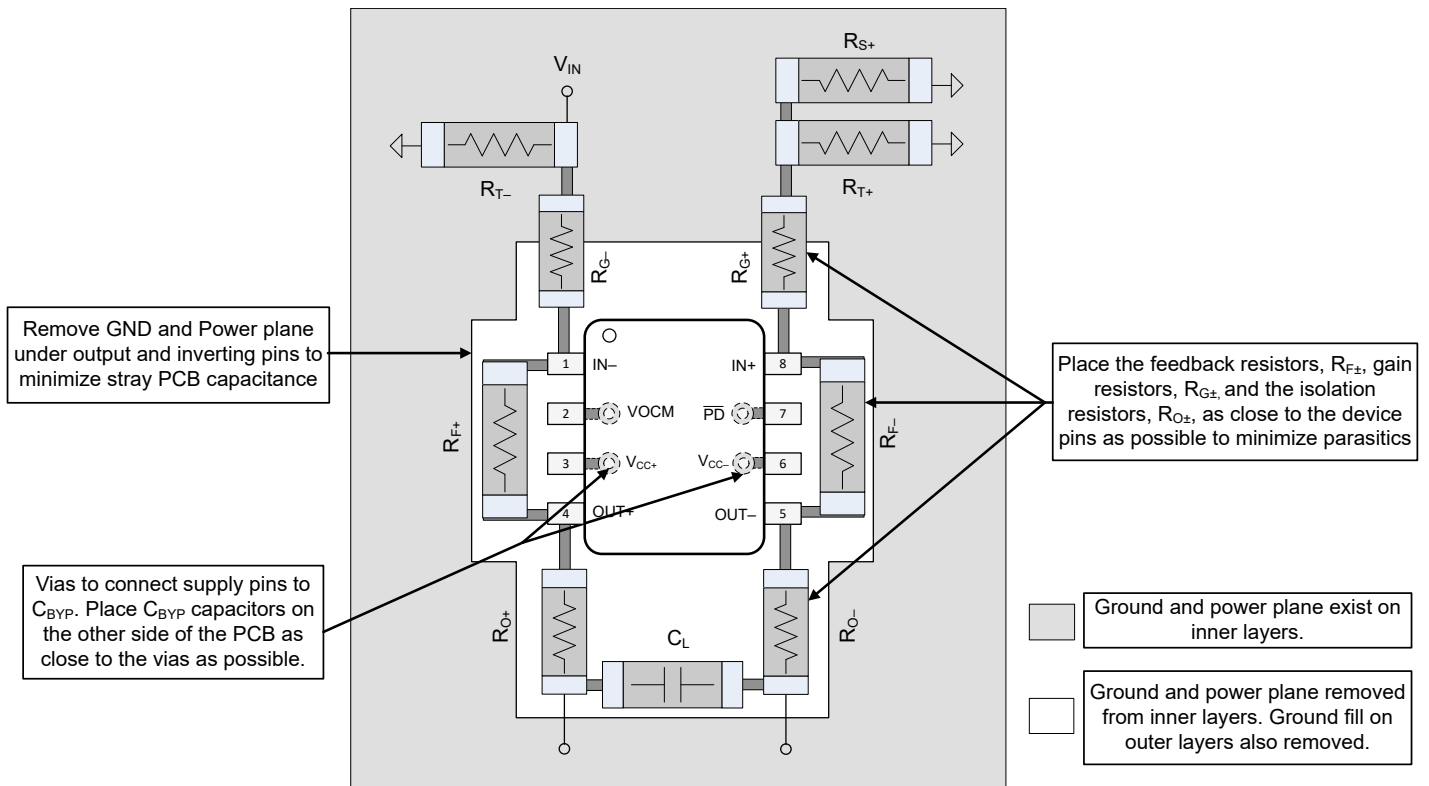

Figure 11-2. Layout Recommendations

11.3 General PowerPAD Design Considerations

The THS413x is available in a thermally-enhanced DGN package, which is a member of the PowerPAD family of packages. This package is constructed using a downset leadframe upon which the die is mounted (see [Figure 11-3 a](#) and [Figure 11-3 b](#)). This arrangement results in the lead frame being exposed as a thermal pad on the underside of the package (see [Figure 11-3 c](#)). Because this thermal pad has direct thermal contact with the die, excellent thermal performance can be achieved by providing a good thermal path away from the thermal pad.

The PowerPAD package allows for both assembly and thermal management in one manufacturing operation. During the surface-mount solder operation (when the leads are being soldered), the thermal pad can also be soldered to a copper area underneath the package. Through the use of thermal paths within this copper area, heat can be conducted away from the package into either a ground plane or other heat dissipating device.

The PowerPAD package represents a breakthrough in combining the small area and ease of assembly of the surface mount with the previously awkward mechanical methods of heatsinking.

More complete details of the PowerPAD installation process and thermal management techniques can be found in [PowerPAD Thermally-Enhanced Package](#). This document can be found on the TI website (www.ti.com) by searching on the key word PowerPAD. The document can also be ordered through your local TI sales office. Refer to SLMA002 when ordering.

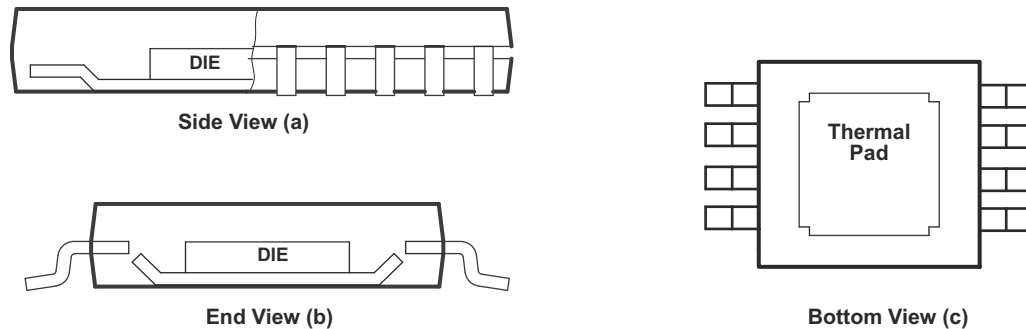

- A. The thermal pad (PowerPAD) is electrically isolated from all other pins and can be connected to any potential from V_{CC-} to V_{CC+} . Typically, the thermal pad is connected to the ground plane because this plane tends to physically be the largest and is able to dissipate the most amount of heat.

Figure 11-3. Views of Thermally-Enhanced DGN Package

12 Device and Documentation Support

12.1 Documentation Support

12.1.1 Related Documentation

For related documentation, see the following:

- Texas Instruments, [Design Guide for 2.3 nV/√Hz, Differential, Time Gain Control \(TGC\) DAC Reference Design for Ultrasound design guide](#)
- Texas Instruments, [EVM User's Guide for High-Speed Fully-Differential Amplifier user's guide](#)
- Texas Instruments, [Fully Differential Amplifiers application note](#)
- Texas Instruments, [Maximizing Signal Chain Distortion Performance Using High Speed Amplifiers application note](#)
- Texas Instruments, [PowerPAD Thermally-Enhanced Package application report](#)
- Texas Instruments, [PowerPAD™ Made Easy application report](#)
- Texas Instruments, [TI Precision Labs - Fully Differential Amplifiers video series](#)

12.2 Receiving Notification of Documentation Updates

To receive notification of documentation updates, navigate to the device product folder on ti.com. Click on *Subscribe to updates* to register and receive a weekly digest of any product information that has changed. For change details, review the revision history included in any revised document.

12.3 Support Resources

[TI E2E™ support forums](#) are an engineer's go-to source for fast, verified answers and design help — straight from the experts. Search existing answers or ask your own question to get the quick design help you need.

Linked content is provided "AS IS" by the respective contributors. They do not constitute TI specifications and do not necessarily reflect TI's views; see TI's [Terms of Use](#).

12.4 Trademarks

PowerPAD™ are trademarks of Texas Instruments.

TI E2E™ is a trademark of Texas Instruments.

All trademarks are the property of their respective owners.

12.5 Electrostatic Discharge Caution



This integrated circuit can be damaged by ESD. Texas Instruments recommends that all integrated circuits be handled with appropriate precautions. Failure to observe proper handling and installation procedures can cause damage.

ESD damage can range from subtle performance degradation to complete device failure. Precision integrated circuits may be more susceptible to damage because very small parametric changes could cause the device not to meet its published specifications.

12.6 Glossary

[TI Glossary](#) This glossary lists and explains terms, acronyms, and definitions.

13 Mechanical, Packaging, and Orderable Information

The following pages include mechanical, packaging, and orderable information. This information is the most current data available for the designated devices. This data is subject to change without notice and revision of this document. For browser-based versions of this data sheet, refer to the left-hand navigation.

PACKAGING INFORMATION

Orderable Device	Status (1)	Package Type	Package Drawing	Pins	Package Qty	Eco Plan (2)	Lead finish/ Ball material (6)	MSL Peak Temp (3)	Op Temp (°C)	Device Marking (4/5)	Samples
THS4130CD	ACTIVE	SOIC	D	8	75	RoHS & Green	NIPDAU	Level-1-260C-UNLIM	0 to 70	4130C	Samples
THS4130CDG4	ACTIVE	SOIC	D	8	75	RoHS & Green	NIPDAU	Level-1-260C-UNLIM	0 to 70	4130C	Samples
THS4130CDGK	NRND	VSSOP	DGK	8	80	RoHS & Green	Call TI NIPDAU	Level-1-260C-UNLIM	0 to 70	ATP	
THS4130CDGN	LIFEBUY	HVSSOP	DGN	8	80	RoHS & Green	NIPDAU	Level-1-260C-UNLIM	0 to 70	AOB	
THS4130CDGNR	LIFEBUY	HVSSOP	DGN	8	2500	RoHS & Green	NIPDAU	Level-1-260C-UNLIM	0 to 70	AOB	
THS4130CDGNRG4	LIFEBUY	HVSSOP	DGN	8	2500	RoHS & Green	NIPDAU	Level-1-260C-UNLIM	0 to 70	AOB	
THS4130ID	LIFEBUY	SOIC	D	8	75	RoHS & Green	NIPDAU	Level-1-260C-UNLIM	-40 to 85	4130I	
THS4130IDGK	NRND	VSSOP	DGK	8	80	RoHS & Green	Call TI NIPDAU	Level-1-260C-UNLIM	-40 to 85	ASO	
THS4130IDGKR	ACTIVE	VSSOP	DGK	8	2500	RoHS & Green	Call TI NIPDAU	Level-1-260C-UNLIM	-40 to 85	ASO	Samples
THS4130IDGN	LIFEBUY	HVSSOP	DGN	8	80	RoHS & Green	NIPDAU	Level-1-260C-UNLIM	-40 to 85	AOC	
THS4130IDGNR	ACTIVE	HVSSOP	DGN	8	2500	RoHS & Green	NIPDAU	Level-1-260C-UNLIM	-40 to 85	AOC	Samples
THS4130IDR	ACTIVE	SOIC	D	8	2500	RoHS & Green	NIPDAU	Level-1-260C-UNLIM	-40 to 85	4130I	Samples
THS4131CD	LIFEBUY	SOIC	D	8	75	RoHS & Green	NIPDAU	Level-1-260C-UNLIM	0 to 70	4131C	
THS4131CDG4	LIFEBUY	SOIC	D	8	75	RoHS & Green	NIPDAU	Level-1-260C-UNLIM	0 to 70	4131C	
THS4131CDGK	NRND	VSSOP	DGK	8	80	RoHS & Green	Call TI NIPDAU	Level-1-260C-UNLIM	0 to 70	ATQ	
THS4131CDGKG4	NRND	VSSOP	DGK	8	80	RoHS & Green	NIPDAU	Level-1-260C-UNLIM	0 to 70	ATQ	
THS4131CDGKR	LIFEBUY	VSSOP	DGK	8	2500	RoHS & Green	Call TI NIPDAU	Level-1-260C-UNLIM	0 to 70	ATQ	
THS4131CDGN	LIFEBUY	HVSSOP	DGN	8	80	RoHS & Green	NIPDAU	Level-1-260C-UNLIM	0 to 70	AOD	
THS4131CDGNG4	LIFEBUY	HVSSOP	DGN	8	80	RoHS & Green	NIPDAU	Level-1-260C-UNLIM	0 to 70	AOD	
THS4131CDGNR	LIFEBUY	HVSSOP	DGN	8	2500	RoHS & Green	NIPDAU	Level-1-260C-UNLIM	0 to 70	AOD	
THS4131CDR	LIFEBUY	SOIC	D	8	2500	RoHS & Green	NIPDAU	Level-1-260C-UNLIM	0 to 70	4131C	
THS4131ID	LIFEBUY	SOIC	D	8	75	RoHS & Green	NIPDAU	Level-1-260C-UNLIM	-40 to 85	4131I	
THS4131IDG4	LIFEBUY	SOIC	D	8	75	RoHS & Green	NIPDAU	Level-1-260C-UNLIM	-40 to 85	4131I	
THS4131IDGK	NRND	VSSOP	DGK	8	80	RoHS & Green	Call TI NIPDAU	Level-1-260C-UNLIM	-40 to 85	ASP	
THS4131IDGKG4	NRND	VSSOP	DGK	8	80	RoHS & Green	NIPDAU	Level-1-260C-UNLIM	-40 to 85	ASP	
THS4131IDGKR	ACTIVE	VSSOP	DGK	8	2500	RoHS & Green	NIPDAU	Level-1-260C-UNLIM	-40 to 85	ASP	Samples

Orderable Device	Status (1)	Package Type	Package Drawing	Pins	Package Qty	Eco Plan (2)	Lead finish/ Ball material (6)	MSL Peak Temp (3)	Op Temp (°C)	Device Marking (4/5)	Samples
THS4131IDGN	LIFEBUY	HVSSOP	DGN	8	80	RoHS & Green	NIPDAU	Level-1-260C-UNLIM	-40 to 85	AOE	
THS4131IDGNG4	LIFEBUY	HVSSOP	DGN	8	80	RoHS & Green	NIPDAU	Level-1-260C-UNLIM	-40 to 85	AOE	
THS4131IDGNR	ACTIVE	HVSSOP	DGN	8	2500	RoHS & Green	NIPDAU	Level-1-260C-UNLIM	-40 to 85	AOE	Samples
THS4131IDR	ACTIVE	SOIC	D	8	2500	RoHS & Green	NIPDAU	Level-1-260C-UNLIM	-40 to 85	4131I	Samples

(1) The marketing status values are defined as follows:

ACTIVE: Product device recommended for new designs.

LIFEBUY: TI has announced that the device will be discontinued, and a lifetime-buy period is in effect.

NRND: Not recommended for new designs. Device is in production to support existing customers, but TI does not recommend using this part in a new design.

PREVIEW: Device has been announced but is not in production. Samples may or may not be available.

OBSOLETE: TI has discontinued the production of the device.

(2) **RoHS:** TI defines "RoHS" to mean semiconductor products that are compliant with the current EU RoHS requirements for all 10 RoHS substances, including the requirement that RoHS substance do not exceed 0.1% by weight in homogeneous materials. Where designed to be soldered at high temperatures, "RoHS" products are suitable for use in specified lead-free processes. TI may reference these types of products as "Pb-Free".

RoHS Exempt: TI defines "RoHS Exempt" to mean products that contain lead but are compliant with EU RoHS pursuant to a specific EU RoHS exemption.

Green: TI defines "Green" to mean the content of Chlorine (Cl) and Bromine (Br) based flame retardants meet JS709B low halogen requirements of <=1000ppm threshold. Antimony trioxide based flame retardants must also meet the <=1000ppm threshold requirement.

(3) MSL, Peak Temp. - The Moisture Sensitivity Level rating according to the JEDEC industry standard classifications, and peak solder temperature.

(4) There may be additional marking, which relates to the logo, the lot trace code information, or the environmental category on the device.

(5) Multiple Device Markings will be inside parentheses. Only one Device Marking contained in parentheses and separated by a "~" will appear on a device. If a line is indented then it is a continuation of the previous line and the two combined represent the entire Device Marking for that device.

(6) Lead finish/Ball material - Orderable Devices may have multiple material finish options. Finish options are separated by a vertical ruled line. Lead finish/Ball material values may wrap to two lines if the finish value exceeds the maximum column width.

Important Information and Disclaimer: The information provided on this page represents TI's knowledge and belief as of the date that it is provided. TI bases its knowledge and belief on information provided by third parties, and makes no representation or warranty as to the accuracy of such information. Efforts are underway to better integrate information from third parties. TI has taken and continues to take reasonable steps to provide representative and accurate information but may not have conducted destructive testing or chemical analysis on incoming materials and chemicals. TI and TI suppliers consider certain information to be proprietary, and thus CAS numbers and other limited information may not be available for release.

In no event shall TI's liability arising out of such information exceed the total purchase price of the TI part(s) at issue in this document sold by TI to Customer on an annual basis.

TAPE AND REEL INFORMATION

QUADRANT ASSIGNMENTS FOR PIN 1 ORIENTATION IN TAPE

*All dimensions are nominal

Device	Package Type	Package Drawing	Pins	SPQ	Reel Diameter (mm)	Reel Width W1 (mm)	A0 (mm)	B0 (mm)	K0 (mm)	P1 (mm)	W (mm)	Pin1 Quadrant
THS4130CDGNR	HVSSOP	DGN	8	2500	330.0	12.4	5.3	3.4	1.4	8.0	12.0	Q1
THS4130IDGKR	VSSOP	DGK	8	2500	330.0	12.4	5.3	3.4	1.4	8.0	12.0	Q1
THS4130IDGNR	HVSSOP	DGN	8	2500	330.0	12.4	5.3	3.4	1.4	8.0	12.0	Q1
THS4130IDR	SOIC	D	8	2500	330.0	12.4	6.4	5.2	2.1	8.0	12.0	Q1
THS4131CDGKR	VSSOP	DGK	8	2500	330.0	12.4	5.3	3.4	1.4	8.0	12.0	Q1
THS4131CDGNR	HVSSOP	DGN	8	2500	330.0	12.4	5.3	3.4	1.4	8.0	12.0	Q1
THS4131CDR	SOIC	D	8	2500	330.0	12.4	6.4	5.2	2.1	8.0	12.0	Q1
THS4131IDGKR	VSSOP	DGK	8	2500	330.0	12.4	5.3	3.4	1.4	8.0	12.0	Q1
THS4131IDGNR	HVSSOP	DGN	8	2500	330.0	12.4	5.3	3.4	1.4	8.0	12.0	Q1
THS4131IDR	SOIC	D	8	2500	330.0	12.4	6.4	5.2	2.1	8.0	12.0	Q1

TAPE AND REEL BOX DIMENSIONS

*All dimensions are nominal

Device	Package Type	Package Drawing	Pins	SPQ	Length (mm)	Width (mm)	Height (mm)
THS4130CDGNR	HVSSOP	DGN	8	2500	358.0	335.0	35.0
THS4130IDGKR	VSSOP	DGK	8	2500	358.0	335.0	35.0
THS4130IDGNR	HVSSOP	DGN	8	2500	358.0	335.0	35.0
THS4130IDR	SOIC	D	8	2500	350.0	350.0	43.0
THS4131CDGKR	VSSOP	DGK	8	2500	358.0	335.0	35.0
THS4131CDGNR	HVSSOP	DGN	8	2500	358.0	335.0	35.0
THS4131CDR	SOIC	D	8	2500	350.0	350.0	43.0
THS4131IDGKR	VSSOP	DGK	8	2500	358.0	335.0	35.0
THS4131IDGNR	HVSSOP	DGN	8	2500	358.0	335.0	35.0
THS4131IDR	SOIC	D	8	2500	350.0	350.0	43.0

TUBE

*All dimensions are nominal

Device	Package Name	Package Type	Pins	SPQ	L (mm)	W (mm)	T (μm)	B (mm)
THS4130CD	D	SOIC	8	75	505.46	6.76	3810	4
THS4130CDG4	D	SOIC	8	75	505.46	6.76	3810	4
THS4130CDGK	DGK	VSSOP	8	80	330	6.55	500	2.88
THS4130ID	D	SOIC	8	75	505.46	6.76	3810	4
THS4130IDGK	DGK	VSSOP	8	80	330	6.55	500	2.88
THS4131CD	D	SOIC	8	75	505.46	6.76	3810	4
THS4131CDG4	D	SOIC	8	75	505.46	6.76	3810	4
THS4131CDGK	DGK	VSSOP	8	80	330	6.55	500	2.88
THS4131CDGKG4	DGK	VSSOP	8	80	330	6.55	500	2.88
THS4131ID	D	SOIC	8	75	505.46	6.76	3810	4
THS4131IDG4	D	SOIC	8	75	505.46	6.76	3810	4
THS4131IDGK	DGK	VSSOP	8	80	330	6.55	500	2.88
THS4131IDGKG4	DGK	VSSOP	8	80	330	6.55	500	2.88

GENERIC PACKAGE VIEW

DGN 8

PowerPAD VSSOP - 1.1 mm max height

3 x 3, 0.65 mm pitch

SMALL OUTLINE PACKAGE

This image is a representation of the package family, actual package may vary.
Refer to the product data sheet for package details.

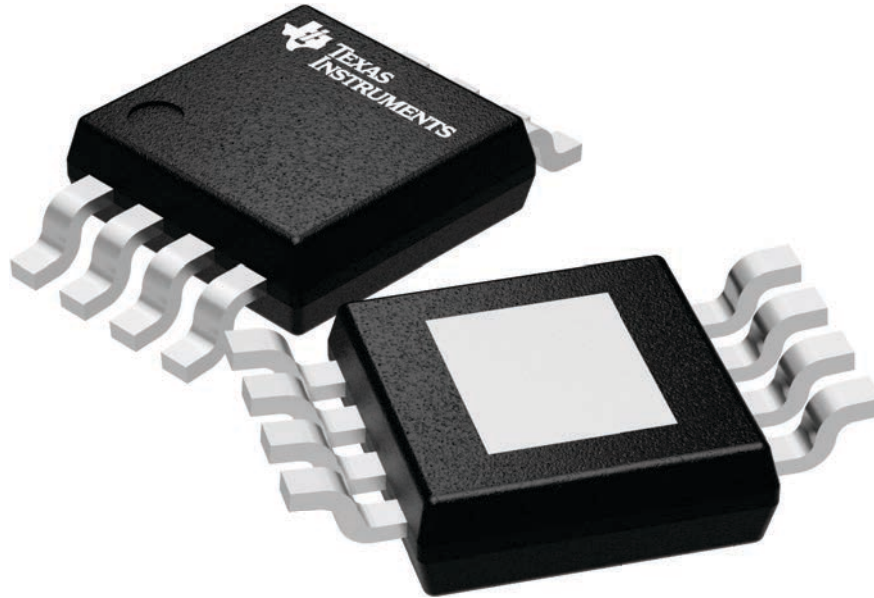

4225482/A



4225481/A 11/2019

PowerPAD is a trademark of Texas Instruments.

NOTES:

1. All linear dimensions are in millimeters. Any dimensions in parenthesis are for reference only. Dimensioning and tolerancing per ASME Y14.5M.
2. This drawing is subject to change without notice.
3. This dimension does not include mold flash, protrusions, or gate burrs. Mold flash, protrusions, or gate burrs shall not exceed 0.15 mm per side.
4. This dimension does not include interlead flash. Interlead flash shall not exceed 0.25 mm per side.
5. Reference JEDEC registration MO-187.

EXAMPLE BOARD LAYOUT

DGN0008D

PowerPAD™ VSSOP - 1.1 mm max height

SMALL OUTLINE PACKAGE



LAND PATTERN EXAMPLE
EXPOSED METAL SHOWN
SCALE: 15X



SOLDER MASK DETAILS

4225481/A 11/2019

NOTES: (continued)

- 6. Publication IPC-7351 may have alternate designs.
- 7. Solder mask tolerances between and around signal pads can vary based on board fabrication site.
- 8. Vias are optional depending on application, refer to device data sheet. If any vias are implemented, refer to their locations shown on this view. It is recommended that vias under paste be filled, plugged or tented.
- 9. Size of metal pad may vary due to creepage requirement.

EXAMPLE STENCIL DESIGN

DGN0008D

PowerPAD™ VSSOP - 1.1 mm max height

SMALL OUTLINE PACKAGE

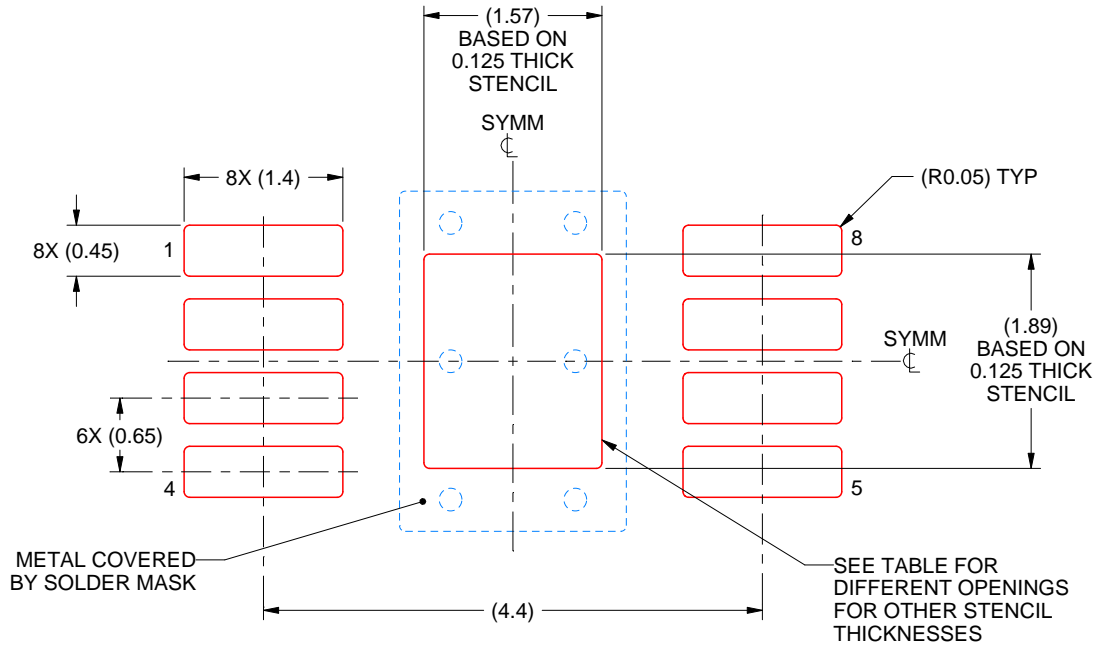

SOLDER PASTE EXAMPLE
EXPOSED PAD 9:
100% PRINTED SOLDER COVERAGE BY AREA
SCALE: 15X

STENCIL THICKNESS	SOLDER STENCIL OPENING
0.1	1.76 X 2.11
0.125	1.57 X 1.89 (SHOWN)
0.15	1.43 X 1.73
0.175	1.33 X 1.60

4225481/A 11/2019

NOTES: (continued)

10. Laser cutting apertures with trapezoidal walls and rounded corners may offer better paste release. IPC-7525 may have alternate design recommendations.
11. Board assembly site may have different recommendations for stencil design.



D0008A

PACKAGE OUTLINE

SOIC - 1.75 mm max height

SMALL OUTLINE INTEGRATED CIRCUIT



4214825/C 02/2019

NOTES:

- Linear dimensions are in inches [millimeters]. Dimensions in parenthesis are for reference only. Controlling dimensions are in inches. Dimensioning and tolerancing per ASME Y14.5M.
- This drawing is subject to change without notice.
- This dimension does not include mold flash, protrusions, or gate burrs. Mold flash, protrusions, or gate burrs shall not exceed $.006$ [0.15] per side.
- This dimension does not include interlead flash.
- Reference JEDEC registration MS-012, variation AA.

EXAMPLE BOARD LAYOUT

D0008A

SOIC - 1.75 mm max height

SMALL OUTLINE INTEGRATED CIRCUIT



LAND PATTERN EXAMPLE
 EXPOSED METAL SHOWN
 SCALE:8X



SOLDER MASK DETAILS

4214825/C 02/2019

NOTES: (continued)

- 6. Publication IPC-7351 may have alternate designs.
- 7. Solder mask tolerances between and around signal pads can vary based on board fabrication site.

EXAMPLE STENCIL DESIGN

D0008A

SOIC - 1.75 mm max height

SMALL OUTLINE INTEGRATED CIRCUIT



SOLDER PASTE EXAMPLE
BASED ON .005 INCH [0.125 MM] THICK STENCIL
SCALE:8X

4214825/C 02/2019

NOTES: (continued)

8. Laser cutting apertures with trapezoidal walls and rounded corners may offer better paste release. IPC-7525 may have alternate design recommendations.
9. Board assembly site may have different recommendations for stencil design.

DGK (S-PDSO-G8)

PLASTIC SMALL-OUTLINE PACKAGE



- NOTES:
- A. All linear dimensions are in millimeters.
 - B. This drawing is subject to change without notice.
 - C. Body length does not include mold flash, protrusions, or gate burrs. Mold flash, protrusions, or gate burrs shall not exceed 0.15 per end.
 - D. Body width does not include interlead flash. Interlead flash shall not exceed 0.50 per side.
 - E. Falls within JEDEC MO-187 variation AA, except interlead flash.



- NOTES:
- A. All linear dimensions are in millimeters.
 - B. This drawing is subject to change without notice.
 - C. Publication IPC-7351 is recommended for alternate designs.
 - D. Laser cutting apertures with trapezoidal walls and also rounding corners will offer better paste release. Customers should contact their board assembly site for stencil design recommendations. Refer to IPC-7525 for other stencil recommendations.
 - E. Customers should contact their board fabrication site for solder mask tolerances between and around signal pads.

IMPORTANT NOTICE AND DISCLAIMER

TI PROVIDES TECHNICAL AND RELIABILITY DATA (INCLUDING DATA SHEETS), DESIGN RESOURCES (INCLUDING REFERENCE DESIGNS), APPLICATION OR OTHER DESIGN ADVICE, WEB TOOLS, SAFETY INFORMATION, AND OTHER RESOURCES "AS IS" AND WITH ALL FAULTS, AND DISCLAIMS ALL WARRANTIES, EXPRESS AND IMPLIED, INCLUDING WITHOUT LIMITATION ANY IMPLIED WARRANTIES OF MERCHANTABILITY, FITNESS FOR A PARTICULAR PURPOSE OR NON-INFRINGEMENT OF THIRD PARTY INTELLECTUAL PROPERTY RIGHTS.

These resources are intended for skilled developers designing with TI products. You are solely responsible for (1) selecting the appropriate TI products for your application, (2) designing, validating and testing your application, and (3) ensuring your application meets applicable standards, and any other safety, security, regulatory or other requirements.

These resources are subject to change without notice. TI grants you permission to use these resources only for development of an application that uses the TI products described in the resource. Other reproduction and display of these resources is prohibited. No license is granted to any other TI intellectual property right or to any third party intellectual property right. TI disclaims responsibility for, and you will fully indemnify TI and its representatives against, any claims, damages, costs, losses, and liabilities arising out of your use of these resources.

TI's products are provided subject to [TI's Terms of Sale](#) or other applicable terms available either on [ti.com](https://www.ti.com) or provided in conjunction with such TI products. TI's provision of these resources does not expand or otherwise alter TI's applicable warranties or warranty disclaimers for TI products.

TI objects to and rejects any additional or different terms you may have proposed.

Mailing Address: Texas Instruments, Post Office Box 655303, Dallas, Texas 75265
Copyright © 2023, Texas Instruments Incorporated