



MP28167

2.8V-22V V_{IN} , 3A I_{OUT} , 4-Switch Integrated Buck-Boost Converter with Fixed 5V Output

DESCRIPTION

The MP28167 is a synchronous, 4-switch, integrated buck-boost converter, capable of regulating the output voltage across a 2.8V to 22V wide input voltage range with high efficiency.

The MP28167 uses constant-on-time control in buck mode and constant-off-time control in boost mode, providing fast load transient response as well as smooth buck-boost mode transient. The MP28167 provides forced PWM switching mode and programmable output CC (constant current) limit, which supports flexible design for different applications.

Full protection features include over-current protection (OCP), over-voltage protection (OVP), under-voltage protection (UVP), and thermal shutdown.

The MP28167 is available in a 16-pin QFN (3mmx3mm) package.

FEATURES

- Wide 2.8V to 22V Operating Input Voltage Range
- Fixed 5V Output Voltage
- 3A Output Current or 4A Input Current
- 130mV Line Drop Compensation
- 500kHz Fixed Switching Frequency
- Forced PWM Switching Mode
- Four Low $R_{DS(ON)}$ Internal Buck Power MOSFETs
- Adjustable Accurate CC Output Current Limit with Internal Sensing FET
- Output Over-Voltage Hiccup Protection
- Output Short-Circuitry Hiccup Protection
- Over-Temperature Shutdown
- EN Shutdown Discharge Function
- Available in a QFN-16 (3mmx3mm) Package

APPLICATIONS

- Buck-Boost Bus Supply

All MPS parts are lead-free, halogen free, and adhere to the RoHS directive. For MPS green status, please visit the MPS website under Quality Assurance. "MPS," the MPS logo, and "Simple, Easy Solutions" are registered trademarks of Monolithic Power Systems, Inc. or its subsidiaries.

TYPICAL APPLICATION

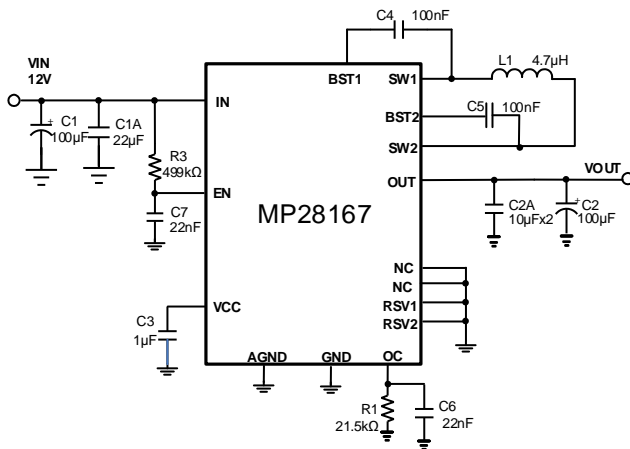

Efficiency vs. Output Current

$V_{IN} = 12V$, $V_{OUT} = 5V$, $L = 4.7\mu H$, $R_{DC} = 19.7m\Omega$

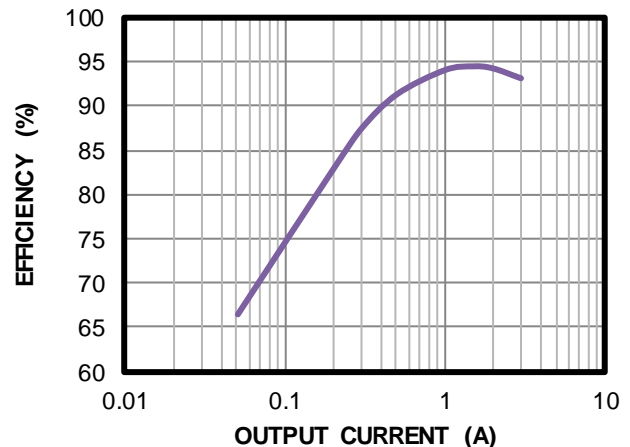

ORDERING INFORMATION

Part Number*	Package	Top Marking
MP28167GQ	QFN-16 (3mmx3mm)	See Below

* For Tape & Reel, add suffix -Z (e.g. MP28167GQ-Z).

TOP MARKING

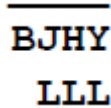
BJHY
LLL

BJH: Product code of MP28167GQ
 Y: Year code
 LLL: Lot number

PACKAGE REFERENCE

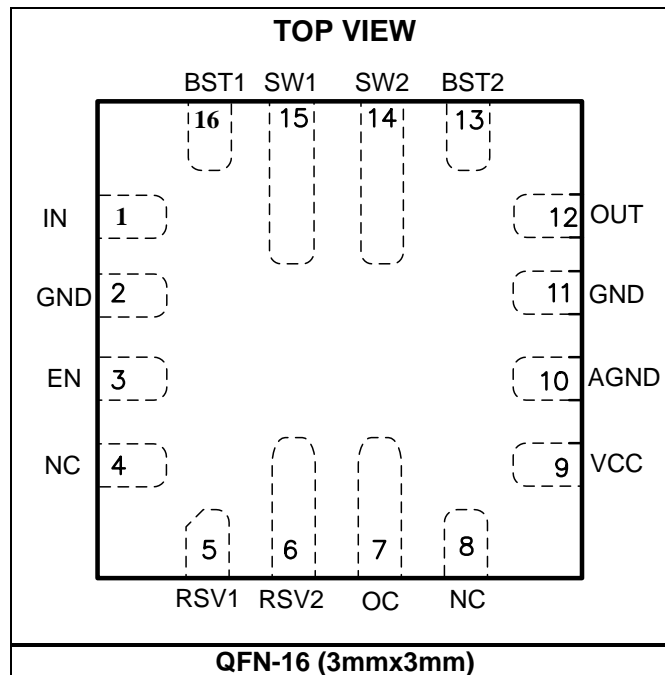

PIN FUNCTIONS

Pin #	Name	Description
1	IN	Supply voltage. IN is the drain of the internal power device and provides power to the entire chip. The MP28167 operates from a 2.8V to 22V input voltage. A capacitor (C _{IN}) is required to prevent large voltage spikes from appearing at the input. Place C _{IN} as close to the IC as possible.
2, 11	GND	Power ground. GND is the reference ground of the regulated output voltage. GND requires extra care during PCB layout. Connect GND with copper traces and vias.
3	EN	On/off control for entire chip. Drive EN high to turn on the chip. Drive EN low or float EN to turn off the device. EN has an internal 2MΩ pull-down resistor to ground.
4, 8	NC	No connection. These pins should be connected to GND.
5	RSV1	Reserved pin. This pin cannot be floated. It can be tied to GND or VCC.
6	RSV2	Reserved pin. This pin cannot be floated. It can be tied to GND or VCC.
7	OC	Output constant current limit set pin.
9	VCC	Internal 3.65V LDO regulator output. Decouple VCC with a 1μF capacitor.
10	AGND	Analog ground. Connect AGND to GND.
12	OUT	Output power pin. Place the output capacitor close to OUT and GND.
13	BST2	Bootstrap. Connect a 0.1μF capacitor between SW2 and BST2 to form a floating supply across the high-side switch driver.
14	SW2	Switching node of the second half-bridge. Connect one end of the inductor to SW2 for the current to run through the bridge.
15	SW1	Switching node of the first half-bridge. Connect one end of the inductor to SW1 for the current to run through the bridge.
16	BST1	Bootstrap. Connect a 0.1μF capacitor between SW1 and BST1 to form a floating supply across the high-side switch driver.

ABSOLUTE MAXIMUM RATINGS ⁽¹⁾

Supply voltage (V_{IN} , V_{OUT})	24V
$V_{SW1, SW2}$	$V_{SWx} + 4V$
-0.3V (-7V for <10ns) to $V_{IN} + 0.3V$ (26V for <10ns)	
$V_{BST1, BST2}$	$V_{SWx} + 4V$
V_{EN}	-0.3V to +24V
All other pins	-0.3V to +4V
Continuous power dissipation ($T_A = +25^\circ C$) ^{(2) (4)}	4.8W
Junction temperature	150°C
Lead temperature	260°C
Storage temperature	-65°C to +150°C

Recommended Operating Conditions ⁽³⁾

Operation input voltage range	2.8V to 22V
Output voltage range	Fixed 5V
Output current	3A continuous current or 4A input current
Operating junction temp (T_J)	-40°C to +125°C

Thermal Resistance	θ_{JA}	θ_{JC}
QFN-16 (3mmx3mm)		
EV28167-Q-00A ⁽⁴⁾	26	3... °C/W
JESD51-7 ⁽⁵⁾	50	12... °C/W

Notes:

- 1) Exceeding these ratings may damage the device.
- 2) The maximum allowable power dissipation is a function of the maximum junction temperature T_J (MAX), the junction-to-ambient thermal resistance θ_{JA} , and the ambient temperature T_A . The maximum allowable continuous power dissipation at any ambient temperature is calculated by P_D (MAX) = $(T_J$ (MAX) - T_A) / θ_{JA} . Exceeding the maximum allowable power dissipation will cause excessive die temperature, and the regulator will go into thermal shutdown. Internal thermal shutdown circuitry protects the device from permanent damage.
- 3) The device is not guaranteed to function outside of its operating conditions.
- 4) Measured on EV28167-Q-00A, 4-layer-PCB, 64mmx64mm.
- 5) Measured on JESD51-7, 4-layer PCB. The value of θ_{JA} given in this table is only valid for comparison with other packages and cannot be used for design purposes. These values were calculated in accordance with JESD51-7, and simulated on a specified JEDEC board. They do not represent the performance obtained in an actual application.

ELECTRICAL CHARACTERISTICS

V_{IN} = 12V, V_{EN} = 5V, T_J = -40°C to +125°C ⁽⁶⁾, typical value is tested at T_J = +25°C, unless otherwise noted.

Parameter	Symbol	Condition	Min	Typ	Max	Units
Supply current (shutdown)	I _{IN}	V _{EN} = 0V		0	3	μA
Supply current (quiescent)	I _Q	Remove inductor, add 5.8V to V _{OUT}		1		mA
EN rising threshold	V _{EN_Rising}		1.0	1.10	1.2	V
EN hysteresis	V _{EN_Falling}		65	110	160	mV
EN to ground resistance	R _{EN}	V _{EN} = 2V		2		MΩ
EN on to V _{OUT} > 90% delay	T _{Delay}	See Figure 7			500	μs
VCC regulator	V _{CC}		3.3	3.65	4	V
VCC load regulation	V _{CC_LOG}	I _{CC} = 10mA		1		%
V _{IN} under-voltage lockout threshold rising	V _{IN_UVLO}		2.50	2.65	2.8	V
V _{IN} under-voltage lockout threshold hysteresis	V _{UVLO_HYS}		95	160	205	mV
Power Converter						
HS switch on resistance	R _{DSON_HS}	Switch A, D		25	40	mΩ
LS switch on resistance	R _{DSON_LSB}	Switch B, C		21	35	mΩ
Output voltage	V _{OUT}		-1.5%	5.0	+1.5%	V
Output discharge resistance	R _{DIS}			60	100	Ω
Switch leakage	SW _{LKG}	V _{EN} = 0V, V _{SW1, SW2} = 22V, T _J = +25°C			1	μA
		V _{EN} = 0V, V _{SW1, SW2} = 22V, T _J = -40°C to +125°C			5	
Oscillator frequency	f _S	T _J = +25°C	-20%	530	20%	kHz
Minimum on time ⁽⁷⁾	t _{ON_MIN1}	Switch A, B, C, D		160		ns
Maximum duty cycle	D _{MAX}	Buck mode, F _{REQ} = 500kHz		85		%
Minimum duty cycle ⁽⁸⁾	D _{MIN}	Boost mode, F _{REQ} = 500kHz		15		%
Protection						
Output over-voltage protection	V _{OVP_R}		150	160	170	%
Output OVP recovery	V _{OVP_F}		130	140	150	%
Low-side B valley limit	I _{LIMIT2}	Switch B	6	8	10	A
Low-side C peak current limit	I _{LIMIT3}	Switch C		10		A
Output average current ⁽⁸⁾	I _{OUT_LIM2}	V _{OUT} = 5V, over 0-125°C temp range	-5%	3.5	+5%	A
Output UV threshold	V _{UVP}	20μs deglitch, UV falling	45%	50%	55%	V _{REF}

ELECTRICAL CHARACTERISTICS (continued)

$V_{IN} = 12V$, $V_{EN} = 5V$, $T_J = -40^{\circ}C$ to $+125^{\circ}C$ ⁽⁶⁾, typical value is tested at $T_J = +25^{\circ}C$, unless otherwise noted.

Parameter	Symbol	Condition	Min	Typ	Max	Units
Thermal shutdown rising threshold ⁽⁷⁾	T_{STD}			150		$^{\circ}C$
Thermal hysteresis ⁽⁷⁾	T_{STD_HYS}			20		$^{\circ}C$

Notes:

- 6) All min/max parameters are tested at $T_J = 25^{\circ}C$. Limits over temperature are guaranteed by design, characterization, and correlation.
- 7) Guarantee by engineering sample characterization.
- 8) Guaranteed by characterization.

TYPICAL PERFORMANCE CHARACTERISTICS

$V_{IN} = 12V$, $V_{OUT} = 5V$, $L = 4.7\mu H$, $T_A = 25^\circ C$, unless otherwise noted.

Efficiency vs. Output Current

$V_{IN} = 12V$, $V_{OUT} = 5V$, $L = 4.7\mu H$, $R_{DC} = 19.7m\Omega$

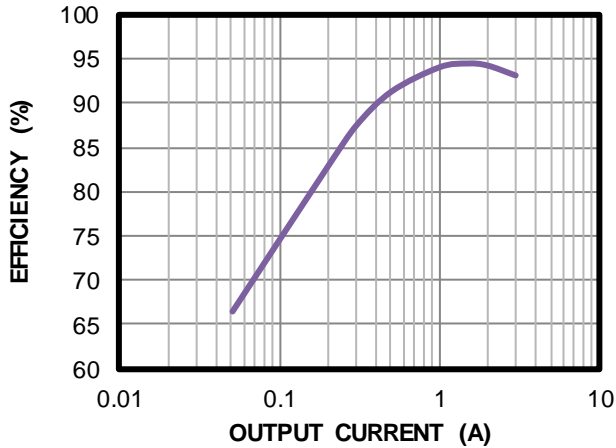

Efficiency vs. Output Current

$V_{IN} = 5V$, $V_{OUT} = 5V$, $L = 4.7\mu H$, $R_{DC} = 19.7m\Omega$

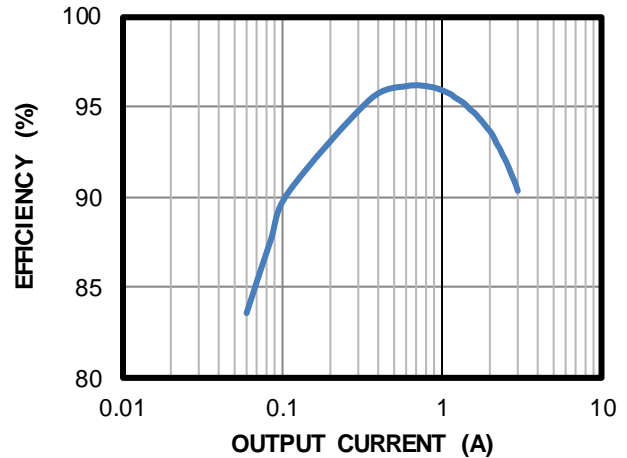

Output Line Drop Compensation vs. Output Current

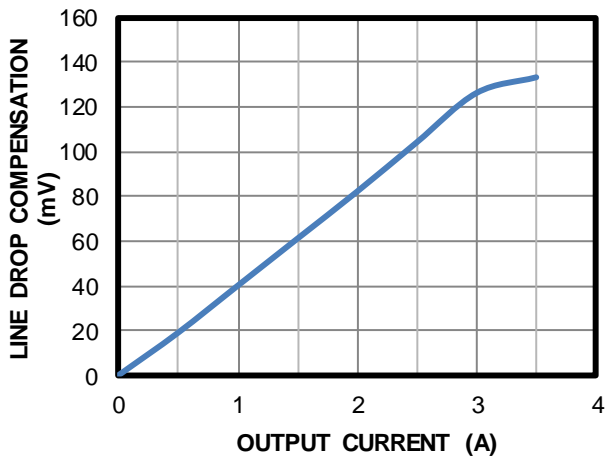

Thermal Rising vs. Output Current

$V_{IN} = 12V$, $V_{OUT} = 5V$, $I_{OUT} = 0A$ to $3A$

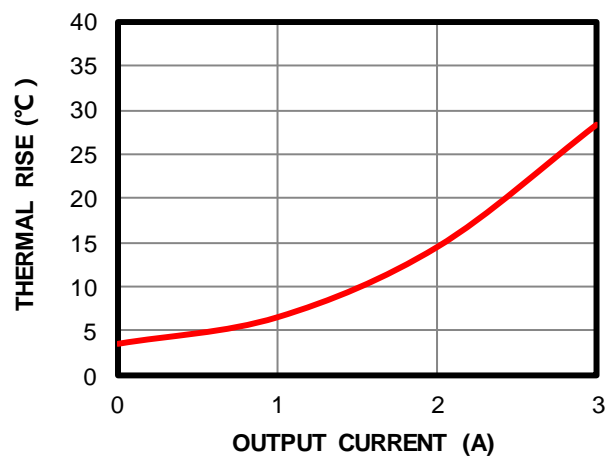

Recommended Maximum I_{OUT} vs. V_{IN} with $120\mu F$ Low-ESR C_{OUT} Capacitor

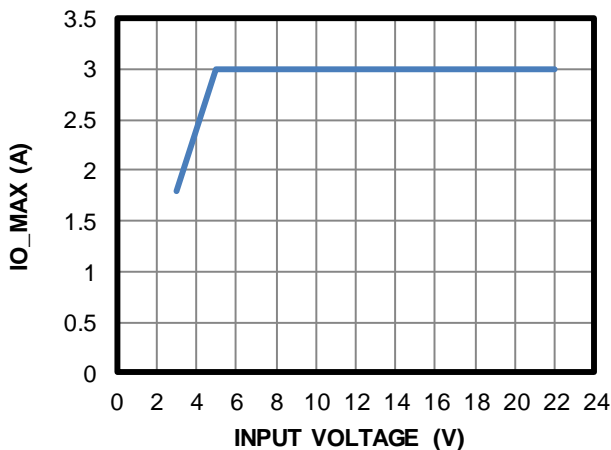

Output Voltage vs. Temperature

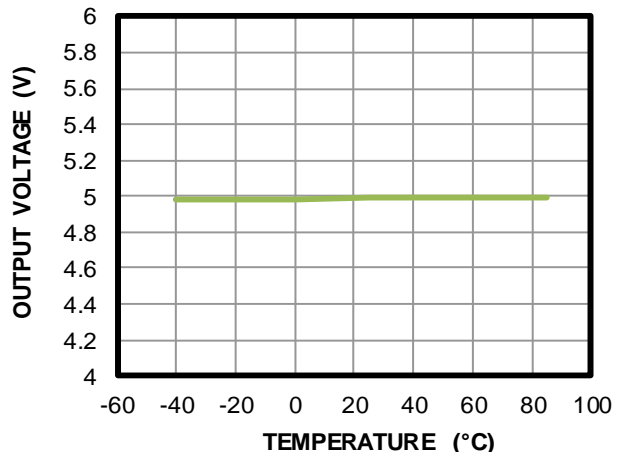

TYPICAL PERFORMANCE CHARACTERISTICS (continued)
 $V_{IN} = 12V$, $V_{OUT} = 5V$, $L = 4.7\mu H$, $T_A = 25^\circ C$, unless otherwise noted.

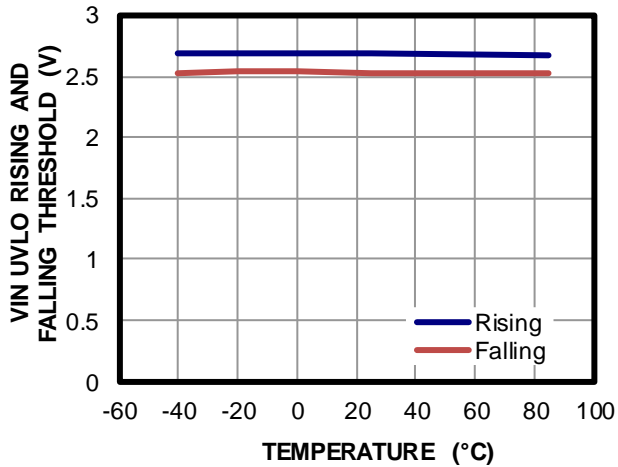
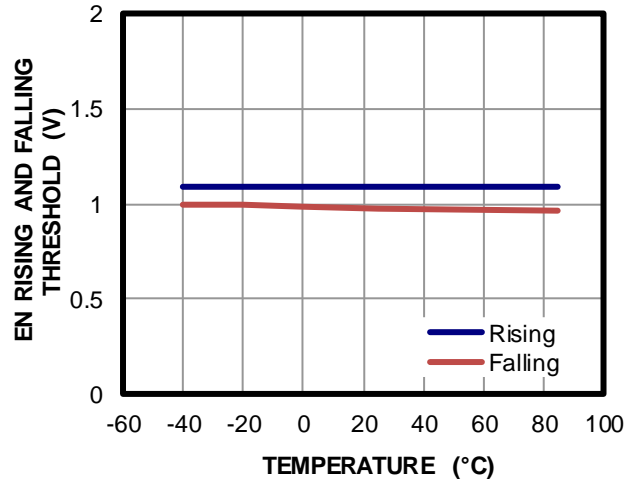
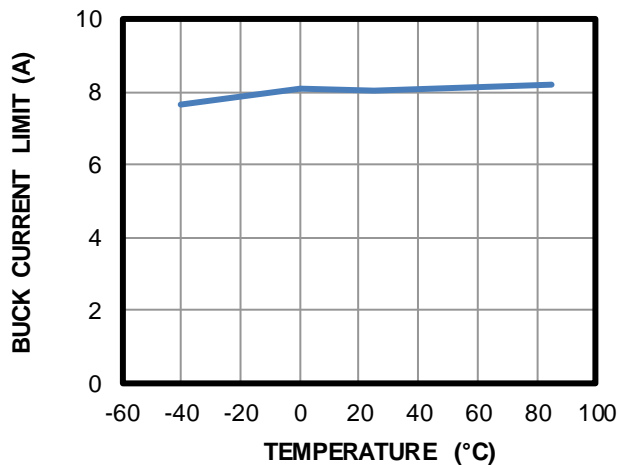
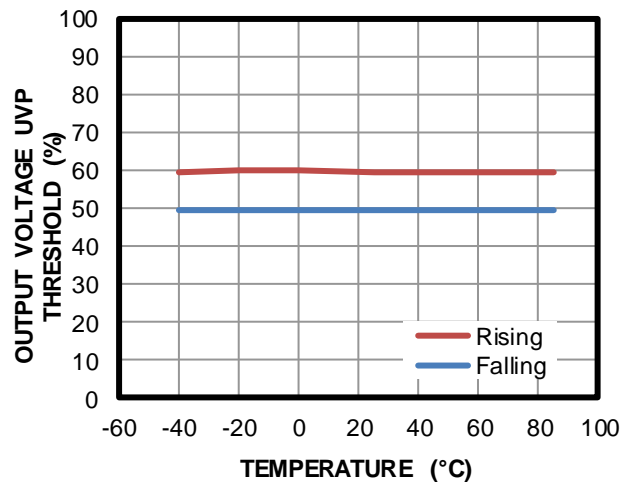
VIN UVLO Rising and Falling Threshold vs. Temperature

EN Rising and Falling Threshold vs. Temperature

Buck Valley Current Limit vs. Temperature

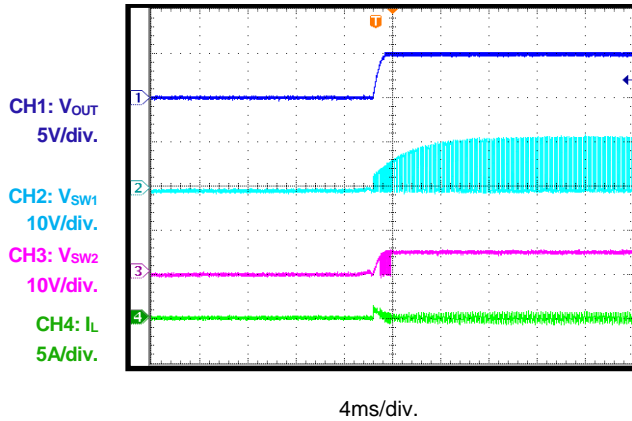
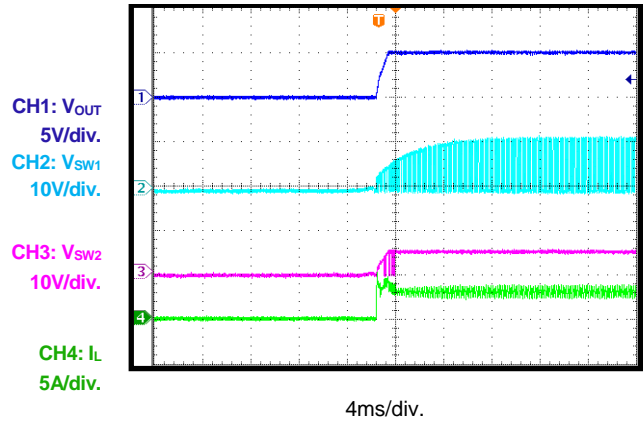
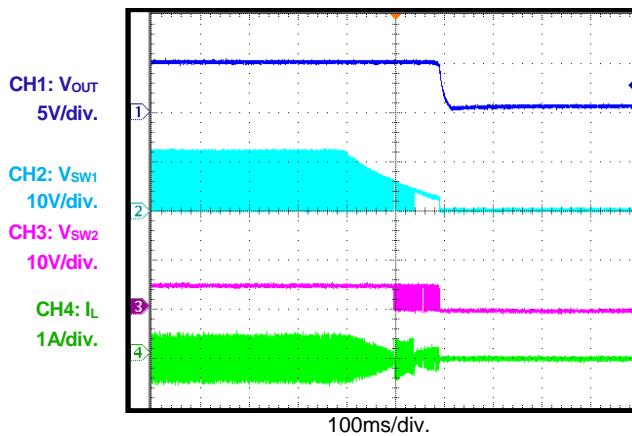
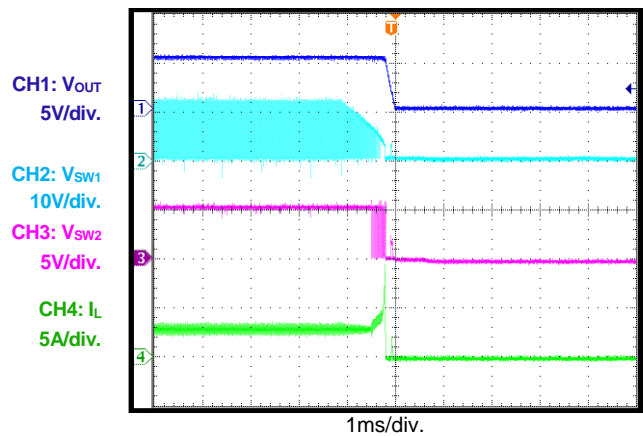
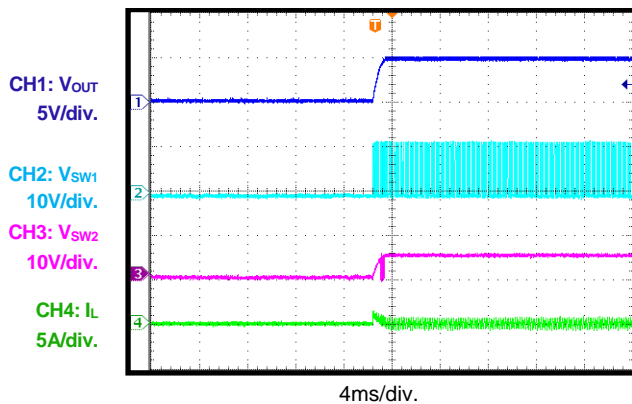
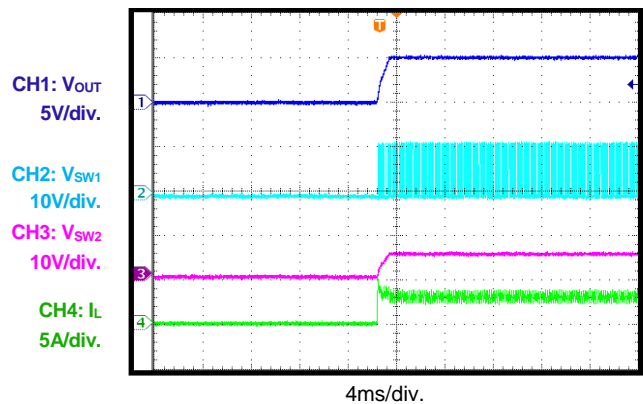
Output Voltage UVP Threshold vs. Temperature

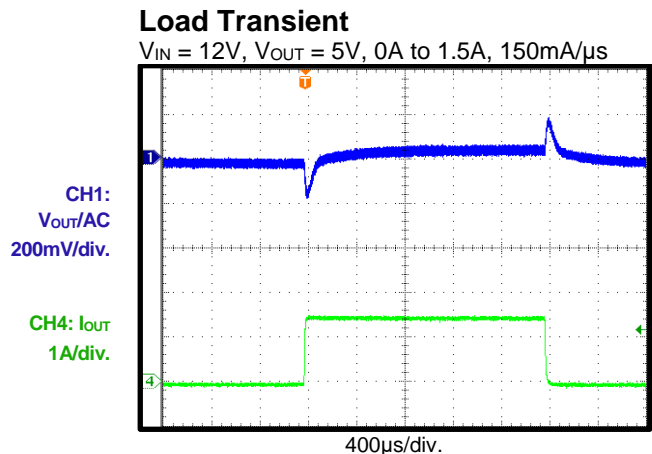
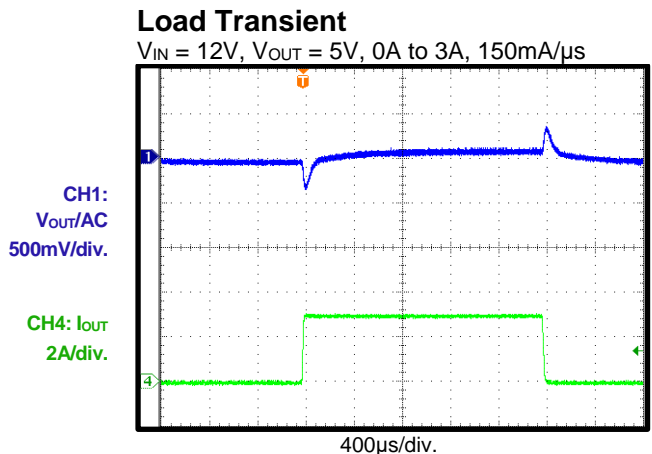
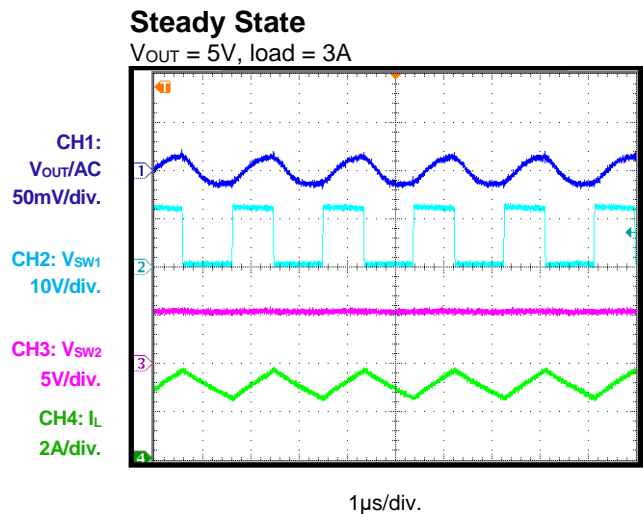
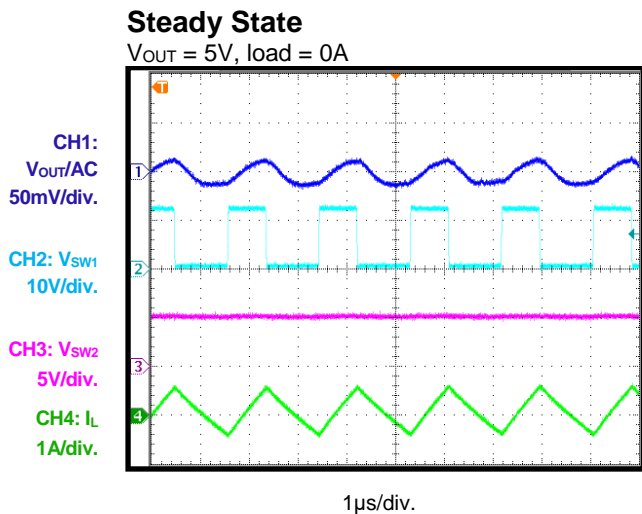
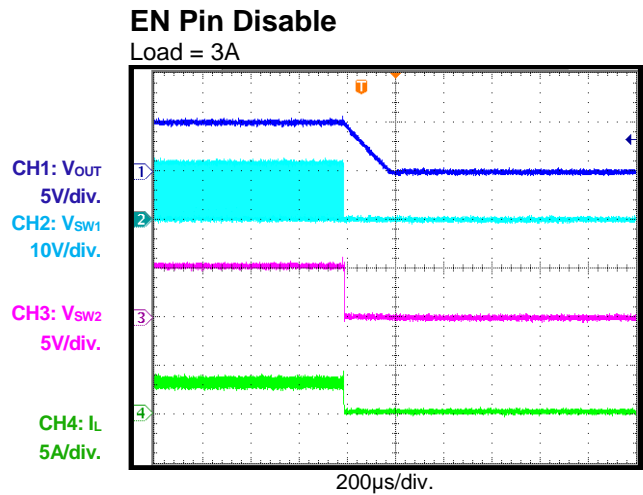
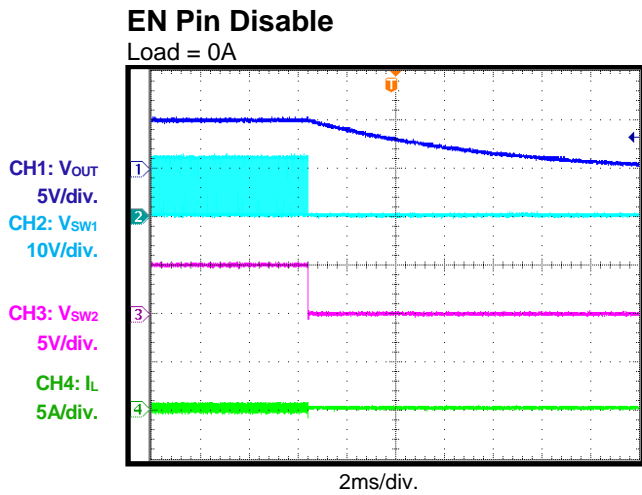
TYPICAL PERFORMANCE CHARACTERISTICS *(continued)*

$V_{IN} = 12V$, $V_{OUT} = 5V$, $L = 4.7\mu H$, $T_A = 25^\circ C$, test waveform is based on Figure 9, unless otherwise noted.

VIN Start-Up
 Load = 0A

VIN Start-Up
 Load = 3A

VIN Power Off
 Load = 0A

VIN Power Off
 Load = 3A

EN Pin Enable
 Load = 0A

EN Pin Enable
 Load = 3A

TYPICAL PERFORMANCE CHARACTERISTICS *(continued)*
 $V_{IN} = 12V$, $V_{OUT} = 5V$, $T_A = 25^\circ C$, $L = 4.7\mu H$, test waveform is based on Figure 9, unless otherwise noted.

TYPICAL PERFORMANCE CHARACTERISTICS *(continued)*

$V_{IN} = 12V$, $V_{OUT} = 5V$, $T_A = 25^\circ C$, $L = 4.7\mu H$, test waveform is based on Figure 9, unless otherwise noted.

Load Transient

$V_{IN} = 12V$, $V_{OUT} = 5V$, 1.5A to 3A, 150mA/ μs

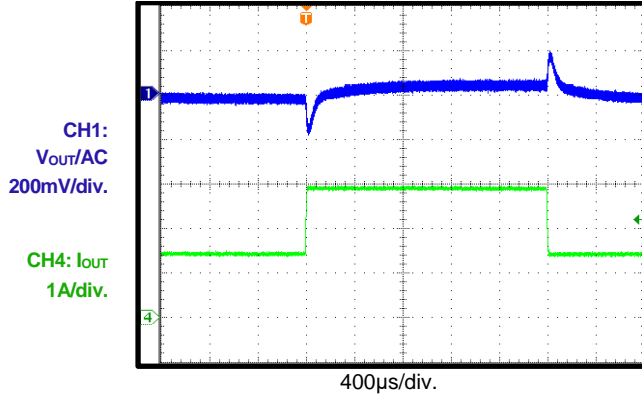
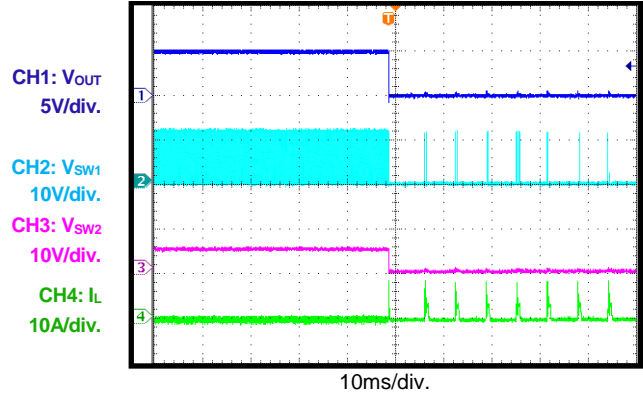
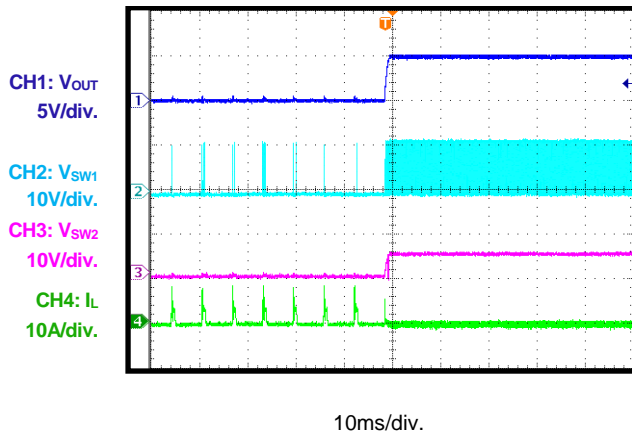
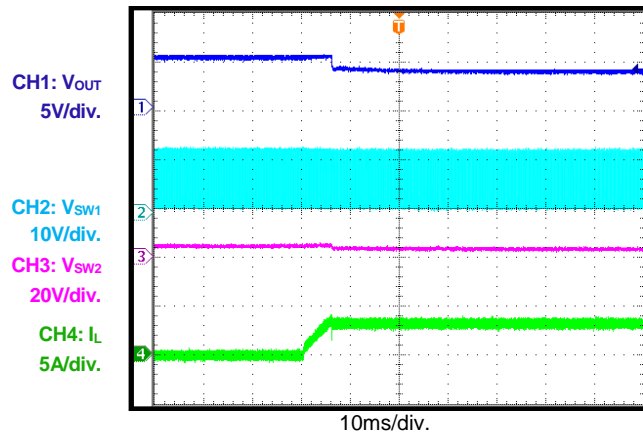
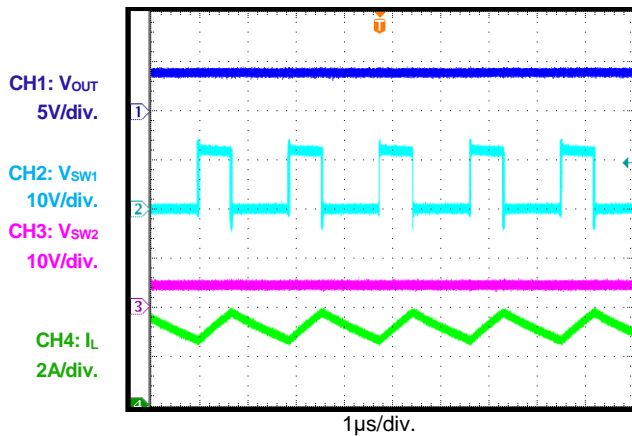
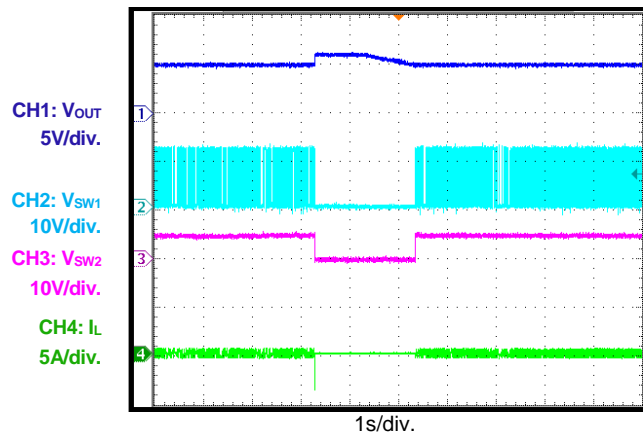
SCP Entry with Hiccup Mode

SCP Recovery with Hiccup Mode

CC Current Limit Entry (Test with CV Mode of Electronic Load)

CC Current Limit Steady State

VOUT OVP with Hiccup Mode

FUNCTIONAL BLOCK DIAGRAM

Figure 1: Functional Block Diagram

OPERATION

The MP28167 is a 4-switch, integrated buck-boost converter that can work in constant-on-time (COT) mode with fixed frequency, which provides fast transient response for buck, boost, and buck-boost modes. One special buck-boost control strategy provides high efficiency over the full input range and smooth transient between different modes.

Figure 1 shows the functional block diagram, and the following sections describe the detail function.

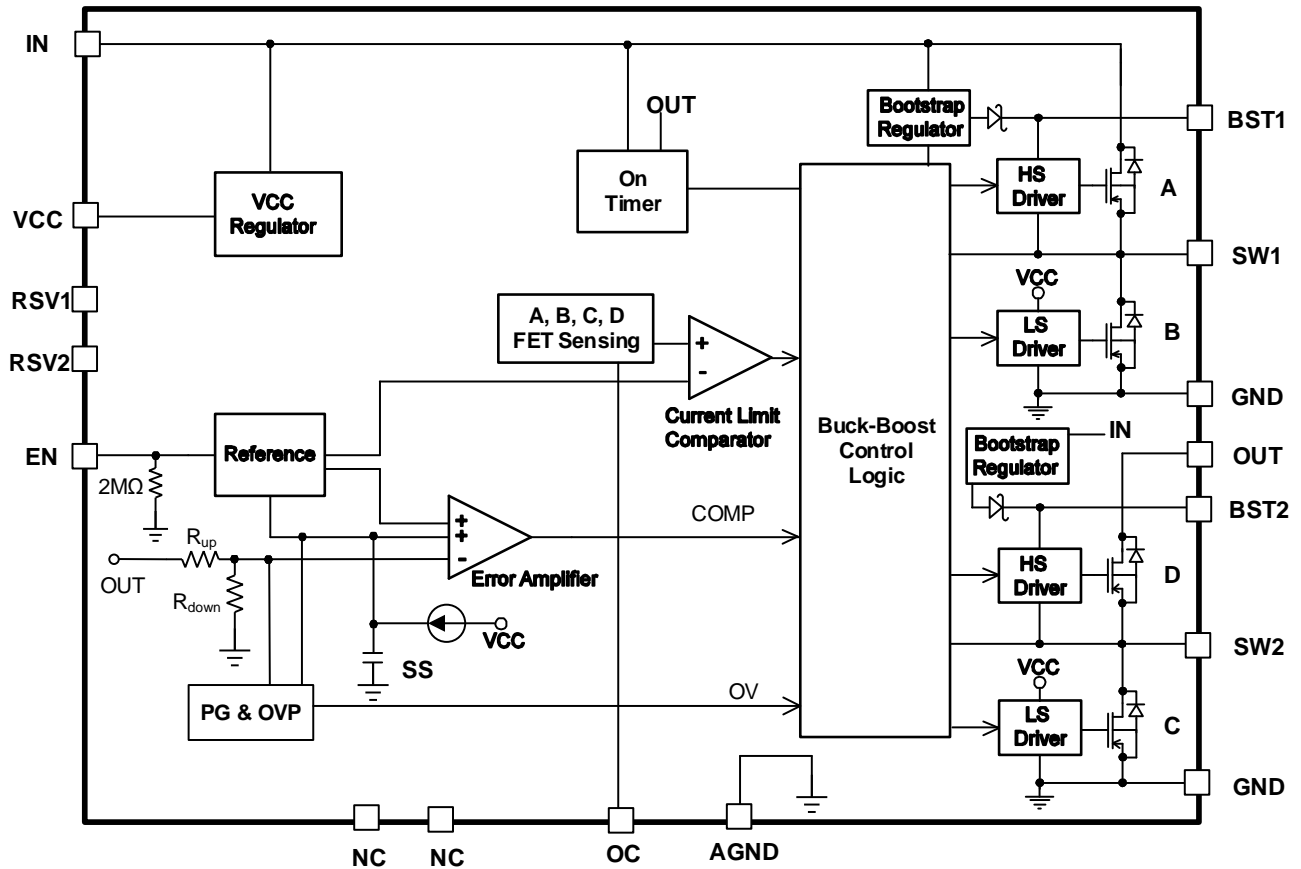
Buck-Boost Operation

The MP28167 can regulate its output to be above, equal to, or below the input voltage. Figure 2 shows the 1-inductor, 4-switch power structure, which operates in buck mode, boost mode, or buck-boost mode with different V_{IN} inputs (see Figure 3).

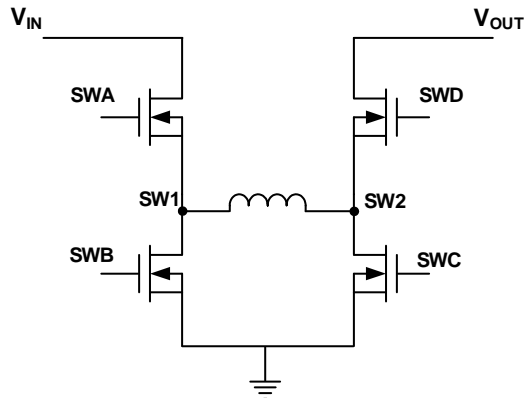

Figure 2: Buck-Boost Topology

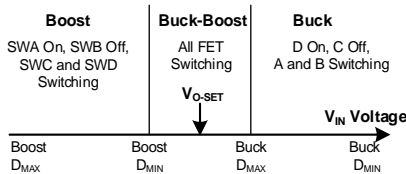

Figure 3: Buck-Boost Operation Range

Buck Mode ($V_{IN} > V_{OUT}$)

When the input voltage is significantly higher than the output voltage, the MP28167 works in buck mode. In buck mode, SWA and SWB switch for the buck regulation, while SWC is off

and SWD remains on to conduct the inductor current.

SWA works with COT control logic and SWB turns on as a complement to SWA. In each cycle, SWB turns on to conduct the inductor current. When the inductor current drops to the COMP voltage, SWB turns off and SWA turns on. SWA turns on for a fixed period and then turns off, after which SWB turns on again and repeats. The COMP signal is the EA output from V_{OUT} feedback and the internal FB reference voltage. Figure 4 shows the buck work waveform.

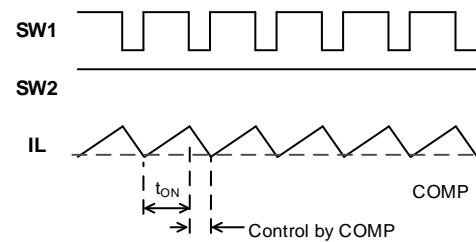

Figure 4: Buck Waveform

Boost Mode ($V_{IN} < V_{OUT}$)

When the input voltage is significantly lower than the output voltage, the MP28167 works in boost mode. In boost mode, SWC and SWD switch for boost regulation, while SWB is off and SWA remains on to conduct the inductor current.

SWC remains off with constant-off-time in each period, while SWD turns on as a complement to SWC to boost the inductor current to output. In each cycle, SWC turns on to conduct the inductor current. When the inductor current reaches the COMP voltage, SWC turns off and SWD turns on. SWC turns off with one fixed off period before it turns on again. During this period, SWD turns on for the current freewheel. Figure 5 shows the boost work waveform.

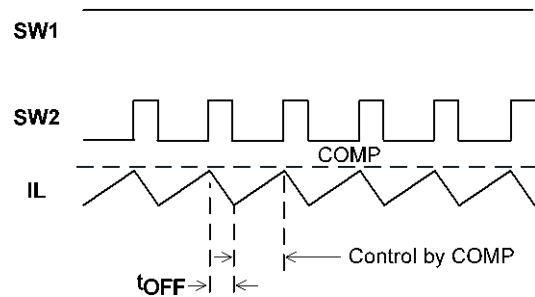

Figure 5: Boost Waveform

Buck-Boost Mode ($V_{IN} \approx V_{OUT}$)

When V_{IN} is close to V_{OUT} , the converter may not be able to provide enough energy to work in buck mode due to SWA's minimum off time, or the converter may supply too much power to V_{OUT} in boost mode due to SWC's minimum on time. The MP28167 uses buck-boost control to regulate the output in these conditions.

In buck mode, if V_{IN} drops and the SWA off period is close to the buck minimum off time, buck-boost mode is engaged. When the next cycle starts after the SWA and SWD on period (buck HS-FET on period), boost starts with SWA and SWC on (boost LS-FET on). Then, SWA and SWD turn on again for the rest of the boost period (boost HS-FET on).

After the boost period elapses, the buck period starts and SWB and SWD remain on until the inductor current drops to the COMP voltage. Then SWA and SWD turn on until next the boost period starts. This repeated process in which the buck and boost switching work with one interval period is called buck-boost mode.

In boost mode, if V_{IN} rises and the SWC on period is close to the boost minimum on time, buck-boost mode is engaged. After the boost constant-off-time period (SWA and SWD on), SWB and SWD remain on until the inductor current signal drops to the COMP voltage, just like a buck off period control.

After the inductor current signal triggers the COMP voltage, SWA and SWD turn on for the buck on time, which is followed by one boost switching (SWA and SWC on), and buck and boost repeat switching work with one interval. Figure 6 shows the buck-boost waveform for both $V_{IN} > V_{OUT}$ and $V_{IN} < V_{OUT}$ conditions.

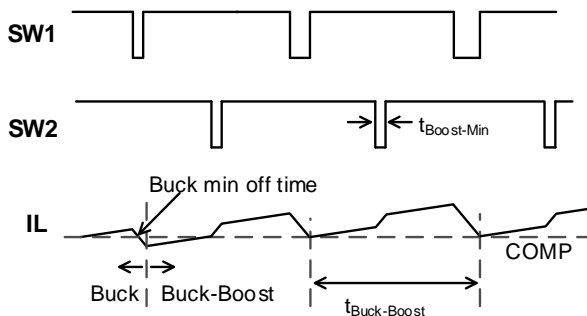

(a) Buck to Buck-Boost Transient

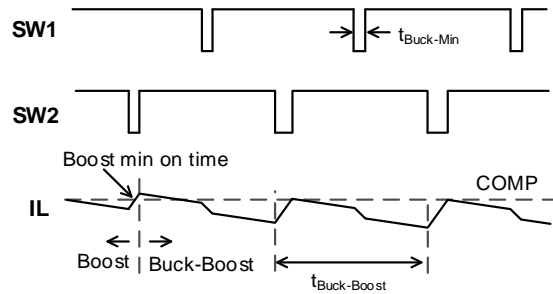

(b) Boost to Buck-Boost Transient

Figure 6: Buck-Boost Waveform

In buck-boost mode, if V_{IN} exceeds 130% of V_{OUT} , the MP28167 shifts from buck-boost mode to buck mode. If V_{IN} is below 20% of V_{OUT} , it shifts from buck-boost mode to boost mode.

Working Mode – FCCM (or Forced PWM) Mode

The MP28167 works in forced PWM mode with fixed frequency. In FCCM conditions, the buck on time and boost off time are determined by an internal circuit to get a fixed frequency based on the V_{IN}/V_{OUT} ratio. When the load decreases, the average input current drops and the inductor current may go to negative from V_{OUT} to V_{IN} during the off time (SWD on). This forces the inductor current to work in continuous mode with fixed frequency, and can produce a lower V_{OUT} ripple.

Internal VCC Regulator

The 3.65V internal regulator powers most of the internal circuitries. This regulator takes V_{IN} and operates in the full V_{IN} range. When V_{IN} exceeds 3.65V, the output of the regulator is in full regulation. If V_{IN} is less than 3.65V, the output decreases with V_{IN} . The VCC requires an external 1 μ F ceramic decoupling capacitor.

Enable Control (EN)

The MP28167 has an enable control (EN). Pull EN high to enable the IC. Pull EN low or float to disable the IC.

Under-Voltage Lockout (UVLO)

Under-voltage lockout (UVLO) protects the chip from operating at an insufficient supply voltage. The UVLO comparator monitors the input voltage, and enables or disables the whole IC.

Internal Soft Start (SS)

The soft start (SS) prevents the converter output voltage from overshooting during start-up. When the chip starts up, the internal circuitry generates a SS voltage that ramps up from 0V to 3.65V. When SS is lower than V_{REF} , the error amplifier uses SS as the reference. When SS is higher than V_{REF} , the error amplifier uses V_{REF} as the reference.

If the output of the MP28167 is pre-biased to a certain voltage during start-up, the IC disables the switching of both the high-side and low-side switches until the voltage on the internal SS capacitor exceeds the internal feedback voltage (see Figure 7).

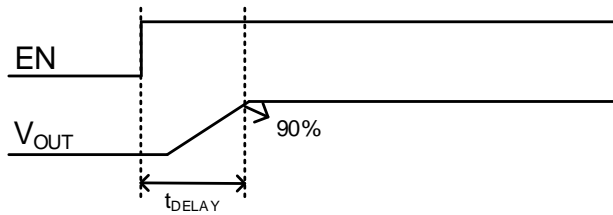

Figure 7: EN On to $V_{OUT} > 90\%$ Delay

Output Constant Current Limit (OCP)

The MP28167 has a constant current limit control loop to limit the output average current. The current information is sensed from switches A, B, C, and D. Then an average algorithm is used to calculate the output current.

When the output current exceeds the current-limit threshold, the output voltage starts to drop. If V_{OUT} drops below the under-voltage (UV) threshold (typically 50% below the reference), the MP28167 enters hiccup mode. The part stops switching and recovers automatically with 12.5% duty cycles.

Over-Voltage Protection (OVP)

The MP28167 monitors a resistor-divided feedback voltage to detect output over-voltage. When the feedback voltage exceeds 160% of the

target voltage, the OVP comparator output goes high and the output to ground discharge resistor turns on.

The OUT pin has an absolute OVP function. Once the OUT voltage exceeds the absolute OVP threshold (23V), the MP28167 stops switching and turns on the output to ground discharge resistor.

Start-Up and Shutdown

If both V_{IN} and EN exceed their respective thresholds, the chip is enabled. The reference block starts first, generating a stable reference voltage and current, and then the internal regulator is enabled. The regulator provides a stable supply for the remaining circuitries.

Several events can shut down the chip: EN low, V_{IN} low, and thermal shutdown. In shutdown, the signaling path is blocked to avoid any fault triggering. Then the COMP voltage and the internal supply rails are pulled down. The floating driver is not subject to this shutdown command.

Output Discharge

The MP28167 has an output discharge function that provides a resistive discharge path for the external output capacitor. The function is active when the part is disabled (input voltage is under UVLO or EN is off), and the discharge path turns off when $V_{OUT} < 50\text{mV}$ or the 50ms maximum timer is reached.

Thermal Shutdown (TSD)

Thermal shutdown prevents the part from operating at exceedingly high temperatures.

When the silicon die temperature exceeds 150°C, the entire chip shuts down. When the temperature falls below its lower threshold (typically 130°C), the chip is enabled. This is a non-latch protection.

APPLICATION INFORMATION

Component Selection

The Over-Current Limit Set (R_{SET})

The MP28167 current-limit value should be greater than the normal maximum load current, allowing the tolerances in the current-sense value. The current limit can be determined with Equation (1):

$$R_{SET} (k\Omega) = \frac{75.24}{I_{limit}(A)} \quad (1)$$

This also provides the theory result.

Table 1 lists the recommended ILIM setting resistor and capacitor values, based on the EVB.

Table 1: R_OC vs. I_LIMIT

R_OC (kΩ)	C_OC (nF)	I_LIMIT (A)
75	6.8	0.98
64.9	6.8	1.15
54.9	8.2	1.37
44.2	10	1.72
37.4	12	2.04
30	15	2.54
21.5	22	3.56
15	33	5.11

Selecting the Inductor

As one buck-boost topology circuit, the inductor must support buck applications with the maximum input voltage, and boost applications with the minimum input voltage. Two critical inductance values can be determined, according to the buck mode and boost mode current ripples, using Equation (2) and Equation (3):

$$L_{MIN-BUCK} = \frac{V_{OUT} \times (V_{IN(MAX)} - V_{OUT})}{V_{IN(MAX)} \times f_{REQ} \times \Delta I_L} \quad (2)$$

$$L_{MIN-BOOST} = \frac{V_{IN(MIN)} \times (V_{OUT} - V_{IN(MIN)})}{V_{OUT} \times f_{REQ} \times \Delta I_L} \quad (3)$$

Where f_{REQ} is the switching frequency and ΔI_L is the peak-to-peak inductor current ripple. As a rule of thumb, the peak-to-peak ripple can be set at 10% to 40% of the inductor current. The minimum inductor value for the application must be higher than both the Equation (2) and Equation (3) results.

In addition to the inductance value, to avoid saturation, the inductor must support the peak current, based on Equation (4) and Equation (5):

$$I_{PEAK-BUCK} = I_{OUT} + \frac{V_{OUT} \times (V_{IN(MAX)} - V_{OUT})}{2 \times V_{IN(MAX)} \times f_{REQ} \times L} \quad (4)$$

$$I_{PEAK-BOOST} = \frac{V_{OUT} \times I_{OUT}}{\eta \times V_{IN(MIN)}} + \frac{V_{IN(MIN)} \times (V_{OUT} - V_{IN(MIN)})}{2 \times V_{OUT} \times f_{REQ} \times L} \quad (5)$$

Where η is the estimated efficiency of the MP28167.

Input and Output Capacitor Selection

It is recommended to use ceramic capacitors plus electrolytic capacitors for the input and output capacitors, in order to filter input and output ripple current and obtain stable operation.

The input capacitor requires enough capacitance to absorb the input switching current. For most applications, a 100μF electrolytic capacitor plus a 22μF ceramic capacitor is sufficient.

The output capacitor stabilizes the DC output voltage. Low-ESR capacitors with enough capacitance to limit the output voltage ripple are preferred. Refer to application schematic for more detail.

PCB Layout Guidelines ⁽⁹⁾

Efficient PCB layout is critical for successful operation and thermal dissipation. For best results, refer to Figure 8 and the guidelines below:

1. Place the ceramic C_{IN} and C_{OUT} capacitors close to the IC's V_{IN} -to-GND and OUT -to-GND pins, respectively.
2. Use a large copper plane for PGND. Add multiple vias to improve thermal dissipation. Connect AGND to PGND.
3. Use short, direct, and wide traces to connect OUT . Adding vias under the IC and then routing the OUT trace on both PCB layers is highly recommended.
4. Place a large copper plane for SW1, SW2.
5. Place the VCC decoupling capacitor as close to VCC as possible.

Note:

9) The recommended layout is based on the Typical Application Circuit on page 18.

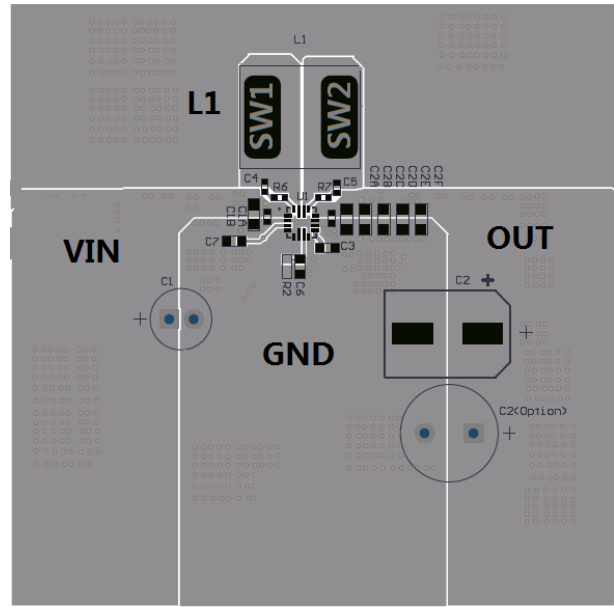

TYPICAL APPLICATION CIRCUITS

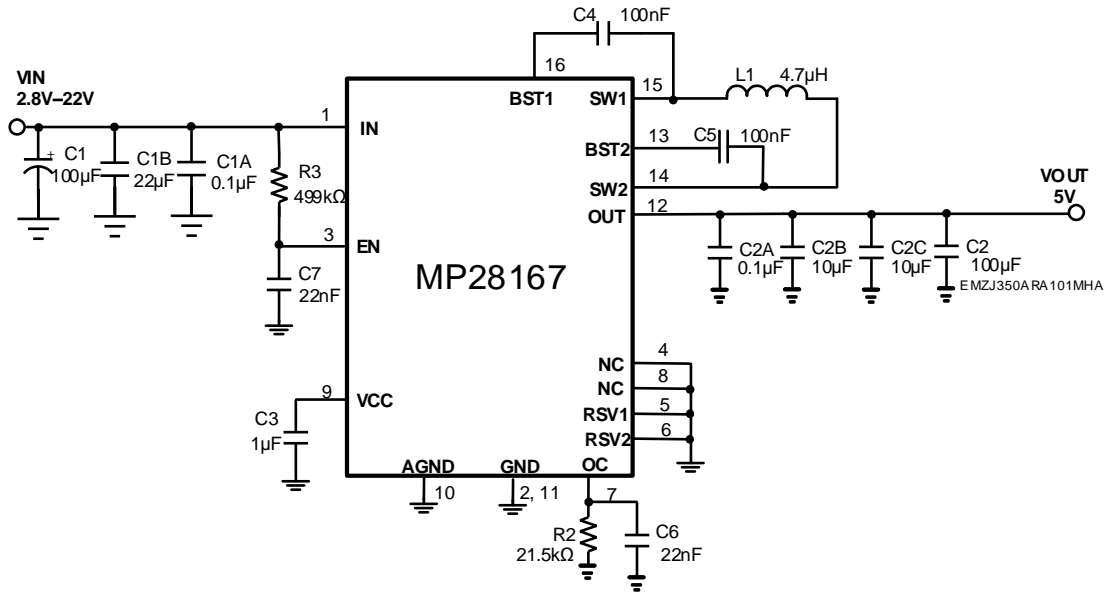

Figure 9: Typical Application Circuit for 2.8V-22V_{IN}, 5V_{OUT}, 3A Output Current or 4A Input Current

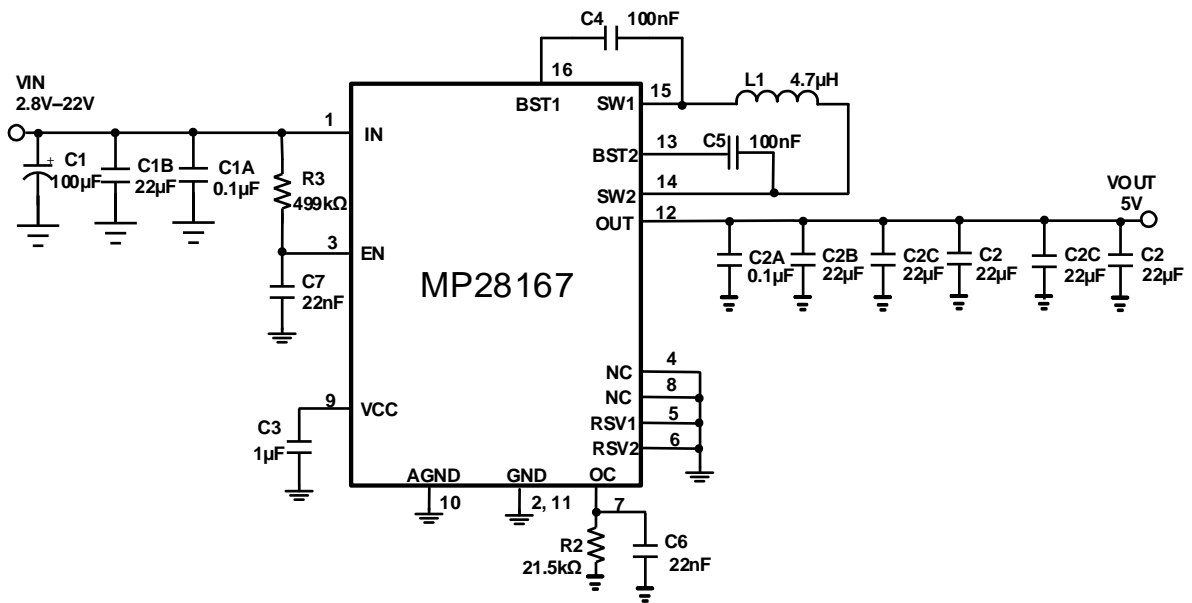
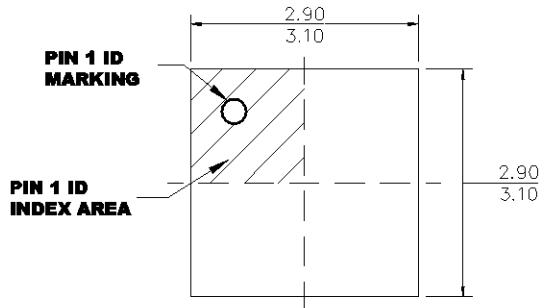

Figure 10: Typical Application Circuit for 2.8V-22V_{IN}, 5V_{OUT}, 3A Output Current or 4A Input Current

PACKAGE INFORMATION

QFN-16 (3mmx3mm)



TOP VIEW

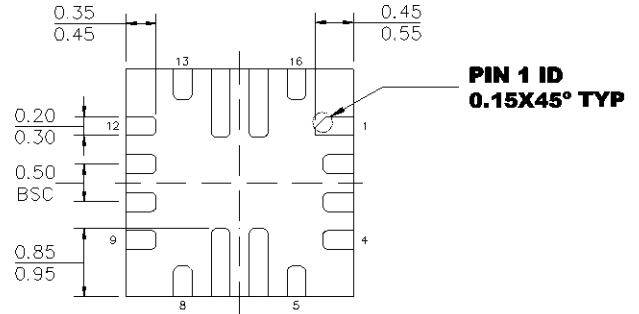

BOTTOM VIEW

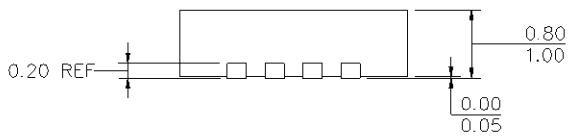

SIDE VIEW

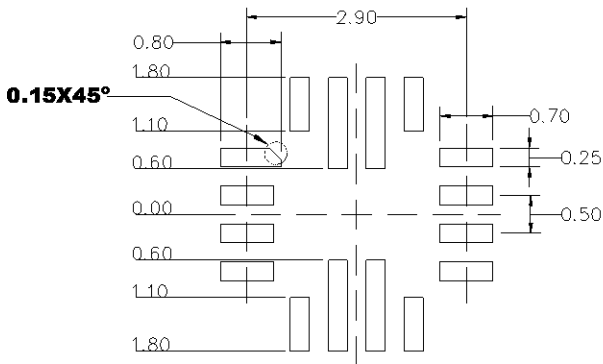

RECOMMENDED LAND PATTERN

NOTE:

- 1) THE LEAD SIDE IS WETTABLE.
- 2) ALL DIMENSIONS ARE IN MILLIMETERS.
- 3) LEAD COPLANARITY SHALL BE 0.08 MILLIMETERS MAX.
- 4) JEDEC REFERENCE IS MO-220.
- 5) DRAWING IS NOT TO SCALE.

NOTICE: The information in this document is subject to change without notice. Users should warrant and guarantee that third-party Intellectual Property rights are not infringed upon when integrating MPS products into any application. MPS will not assume any legal responsibility for any said applications.