

# Octal 3-State Transceiver

## MM74HCT245

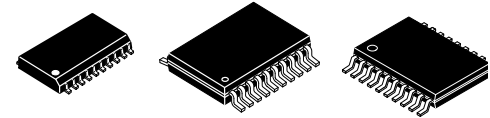

SOIC-20 WB CASE 751D-05    TSSOP-20 WB CASE 948E    TSSOP-20 WB CASE 948AQ

### Description

The MM74HCT245 3-STATE bi-directional buffer utilizes advanced silicon-gate CMOS technology and is intended for two-way asynchronous communication between data buses. It has high drive current outputs which enable high speed operation even when driving large bus capacitances. This circuit possesses the low power consumption of CMOS circuitry, yet has speeds comparable to low power Schottky TTL circuits.

This device is TTL input compatible and can drive up to 15 LS-TTL loads, and all inputs are protected from damage due to static discharge by diodes to V<sub>CC</sub> and ground.

The MM74HCT245 has one active low enable input (G), and a direction control (DIR). When the DIR input is HIGH, data flows from the A inputs to the B outputs. When DIR is LOW, data flows from B to A.

MM74HCT devices are intended to interface between TTL and NMOS components and standard CMOS devices. These parts are also plug-in replacements for LS-TTL devices and can be used to reduce power consumption in existing designs.

### Features

- TTL Input Compatible
- 3-STATE Outputs for connection to system busses
- High Output Drive Current: 6 mA (min)
- High Speed: 16 ns Typical propagation delay
- Low Power: 160 μA (74HCT Series)

### MARKING DIAGRAMS

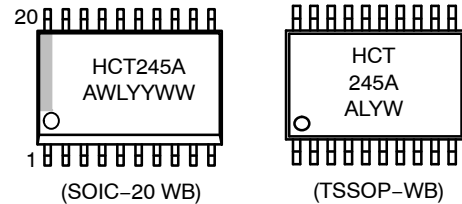

HCT245A= Specific Device Code  
 A        = Assembly Location  
 WL      = Wafer Lot  
 YY      = Year  
 WW      = Work Week

### CONNECTION DIAGRAM

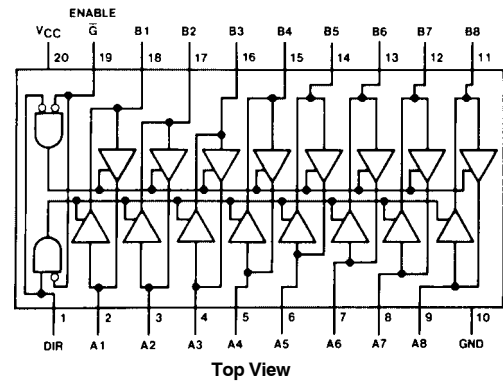

### TRUTH TABLE

Control Inputs		Operation
$\bar{G}$	DIR	245
L	L	B data to A bus
L	L	A data to B bus
H	H	isolation

H = HIGH Level  
 L = LOW Level  
 X = Irrelevant

### ORDERING INFORMATION

See detailed ordering and shipping information on page 5 of this data sheet.



# MM74HCT245

## ABSOLUTE MAXIMUM RATINGS (Note 1) (Note 2)

Symbol	Parameter	Rating	Unit
$V_{CC}$	Supply Voltage	-0.5 to +7.0	V
$V_{IN}$	DC Input Voltage	-0.5 to $V_{CC}+0.5$	V
$V_{OUT}$	DC Output Voltage	-0.5 to $V_{CC}+0.5$	V
$I_{IK}, I_{OK}$	Clamp Diode Current	$\pm 20$	mA
$I_{OUT}$	DC Output Current, per pin	$\pm 35$	mA
$I_{CC}$	Maximum Junction Temperature	$\pm 70$	mA
$T_{STG}$	Storage Temperature Range	-65 to +150	°C
$P_D$	Power Dissipation S.O. Package only	500	mW
$T_L$	Lead Temperature (Soldering 10 seconds)	260	°C

Stresses exceeding those listed in the Maximum Ratings table may damage the device. If any of these limits are exceeded, device functionality should not be assumed, damage may occur and reliability may be affected.

1. Absolute Maximum Ratings are those values beyond which damage to the device may occur.
2. Unless otherwise specified all voltages are referenced to ground.

## RECOMMENDED OPERATING RANGES

Symbol	Parameter	Min.	Max.	Unit
$V_{CC}$	Supply Voltage	4.5	5.5	V
$V_{IN}, V_{OUT}$	DC Input or Output Voltage	0	$V_{CC}$	V
$T_A$	Operating Temperature Range	-55	+125	°C
$t_r, t_f$	Input Rise or Fall Times	-	500	ns

Functional operation above the stresses listed in the Recommended Operating Ranges is not implied. Extended exposure to stresses beyond the Recommended Operating Ranges limits may affect device reliability.

# MM74HCT245

## DC ELECTRICAL CHARACTERISTICS ( $V_{CC} = 5\text{ V} \pm 10\%$ , unless otherwise specified.)

Symbol	Parameter	Test Conditions	$T_A = 25^\circ\text{C}$		$T_A = -40^\circ\text{C}$ to $85^\circ\text{C}$	$T_A = -55^\circ\text{C}$ to $125^\circ\text{C}$	Unit
			Typ.	Guaranteed Limits			
$V_{IH}$	Minimum HIGH Level Input Voltage	–	–	2.0	2.0	2.0	V
$V_{IL}$	Maximum LOW Level Input Voltage	–	–	0.8	0.8	0.8	V
$V_{OH}$	Minimum HIGH Level Output Voltage	$V_{IN} = V_{IH}$ or $V_{IL}$ , $ I_{OUT}  = 20\ \mu\text{A}$ $ I_{OUT}  = 6.0\ \text{mA}, V_{CC} = 4.5\ \text{V}$ $ I_{OUT}  = 7.2\ \text{mA}, V_{CC} = 5.5\ \text{V}$	$V_{CC}$ 4.2 5.2	$V_{CC} - 0.1$ 3.98 4.98	$V_{CC} - 0.1$ 3.84 4.84	$V_{CC} - 0.1$ 3.7 4.7	V
$V_{OL}$	Maximum LOW Level Output Voltage	$V_{IN} = V_{IH}$ or $V_{IL}$ , $ I_{OUT}  = 20\ \mu\text{A}$ $ I_{OUT}  = 6.0\ \text{mA}, V_{CC} = 4.5\ \text{V}$ $ I_{OUT}  = 7.2\ \text{mA}, V_{CC} = 5.5\ \text{V}$	0 0.2 0.2	0.1 0.26 0.26	0.1 0.33 0.33	0.1 0.4 0.4	V
$I_{IN}$	Maximum Input Current	$V_{IN} = V_{CC}$ or GND $V_{IH}$ or $V_{IL}$ , Pin 1 or 19	–	$\pm 0.1$	$\pm 1.0$	$\pm 1.0$	$\mu\text{A}$
$I_{OZ}$	Maximum 3-STATE Output Leakage Current	$V_{out} = V_{CC}$ or GND $\bar{G} = V_{IH}$	–	$\pm 0.5$	$\pm 5.0$	$\pm 10$	$\mu\text{A}$
$I_{CC}$	Maximum Quiescent Supply Current	$V_{IN} = V_{CC}$ or GND, $I_{OUT} = 0\ \mu\text{A}$	–	8	80	160	$\mu\text{A}$
		$V_{IN} = 2.4\ \text{V}$ or $0.5\ \text{V}$ (Note 4)	0.6	1.0	1.3	1.5	mA

3. Measured per input. All other inputs at  $V_{CC}$  or ground.

## AC ELECTRICAL CHARACTERISTICS ( $V_{CC} = 5.0\ \text{V}$ , $t_r = t_f = 6\ \text{ns}$ , $T_A = 25^\circ\text{C}$ unless otherwise specified)

Symbol	Parameter	Test Conditions	Typ.	Guaranteed Limit	Unit
$t_{PHL}, t_{PLH}$	Maximum Output Propagation Delay	$C_L = 45\ \text{pF}$	16	20	ns
$t_{PZL}, t_{PZH}$	Maximum Output Enable Time	$C_L = 45\ \text{pF}$ $R_L = 1\ \text{k}\Omega$	29	40	ns
$t_{PLZ}, t_{PHZ}$	Maximum Output Disable Time	$C_L = 5\ \text{pF}$ $R_L = 1\ \text{k}\Omega$	20	25	ns

# MM74HCT245

## AC ELECTRICAL CHARACTERISTICS ( $V_{CC} = 5.0\text{ V} \pm 10\%$ , $t_r = t_f = 6\text{ ns}$ , unless otherwise specified)

Symbol	Parameter	Test Conditions	$T_A = 25^\circ\text{C}$		$T_A = -40^\circ\text{C}$ to $85^\circ\text{C}$	$T_A = -55^\circ\text{C}$ to $125^\circ\text{C}$	Unit
			Typ.	Guaranteed Limits			
$t_{PHL}, t_{PLH}$	Maximum Output Propagation Delay	$C_L = 50\text{ pF}$	17	23	29	34	ns
		$C_L = 150\text{ pF}$	24	30	38	45	
$t_{PZL}$	Maximum Output Enable Time	$R_L = 1\text{ k}\Omega$ $C_L = 50\text{ pF}$	31	42	53	63	ns
$t_{PZH}$	Maximum Output Enable Time	$R_L = 1\text{ k}\Omega$ $C_L = 50\text{ pF}$	23	33	41	49	ns
$t_{PHZ}, t_{PLZ}$	Maximum Output Disable Time	$R_L = 1\text{ k}\Omega$ $C_L = 50\text{ pF}$	21	30	38	45	ns
$t_{THL}, t_{TLH}$	Maximum Output Rise and Fall Time	$C_L = 50\text{ pF}$	8	12	15 NIL	18	ns
$C_{IN}$	Maximum Input Capacitance	–	10	15	15	15	pF
$C_{OUT}$	Maximum Output/Input Capacitance	–	20	25	25	25	pF
$C_{PD}$	Power Dissipation Capacitance	$\bar{G} = V_{CC}$ (Note 5)	7	–	–	–	pF pF
		$\bar{G} = \text{GND}$	100	–	–	–	

4.  $C_{PD}$  determines the no load dynamic power consumption,  $P_D = C_{PD} V_{CC}^2 f + I_{CC} V_{CC}$ , and the no load dynamic current consumption,  $I_S = C_{PD} V_{CC} f + I_{CC}$ .

## ORDERING INFORMATION

Product Number	Package	Shipping <sup>†</sup>
MM74HCT245MTC	TSSOP–20 WB, Case, 948E (Pb–Free)	75 Units / Tube
MM74HCT245MTCX	TSSOP–20 WB, 948AQ (Pb–Free)	2500 Units / Tape and Reel
MM74HCT245WM	SOIC–20 WB (Pb–Free)	38 Units / Tube
MM74HCT245WMX	SOIC–20 WB (Pb–Free)	1000 Units / Tape and Reel

<sup>†</sup>For information on tape and reel specifications, including part orientation and tape sizes, please refer to our Tape and Reel Packaging Specifications Brochure, [BRD8011/D](#).

# MECHANICAL CASE OUTLINE PACKAGE DIMENSIONS



SCALE 1:1

SOIC-20 WB  
CASE 751D-05  
ISSUE H

DATE 22 APR 2015



NOTES:

1. DIMENSIONS ARE IN MILLIMETERS.
2. INTERPRET DIMENSIONS AND TOLERANCES PER ASME Y14.5M, 1994.
3. DIMENSIONS D AND E DO NOT INCLUDE MOLD PROTRUSION.
4. MAXIMUM MOLD PROTRUSION 0.15 PER SIDE.
5. DIMENSION B DOES NOT INCLUDE DAMBAR PROTRUSION. ALLOWABLE PROTRUSION SHALL BE 0.13 TOTAL IN EXCESS OF B DIMENSION AT MAXIMUM MATERIAL CONDITION.

DIM	MILLIMETERS	
	MIN	MAX
A	2.35	2.65
A1	0.10	0.25
b	0.35	0.49
c	0.23	0.32
D	12.65	12.95
E	7.40	7.60
e	1.27 BSC	
H	10.05	10.55
h	0.25	0.75
L	0.50	0.90
θ	0°	7°

RECOMMENDED  
SOLDERING FOOTPRINT\*



DIMENSIONS: MILLIMETERS

\*For additional information on our Pb-Free strategy and soldering details, please download the ON Semiconductor Soldering and Mounting Techniques Reference Manual, SOLDERRM/D.

GENERIC  
MARKING DIAGRAM\*

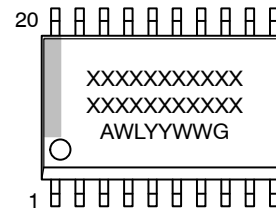

- XXXXXX = Specific Device Code
- A = Assembly Location
- WL = Wafer Lot
- YY = Year
- WW = Work Week
- G = Pb-Free Package

\*This information is generic. Please refer to device data sheet for actual part marking. Pb-Free indicator, "G" or microdot "▪", may or may not be present. Some products may not follow the Generic Marking.

DOCUMENT NUMBER:	98ASB42343B	Electronic versions are uncontrolled except when accessed directly from the Document Repository. Printed versions are uncontrolled except when stamped "CONTROLLED COPY" in red.
DESCRIPTION:	SOIC-20 WB	PAGE 1 OF 1

onsemi and ONsemi are trademarks of Semiconductor Components Industries, LLC dba onsemi or its subsidiaries in the United States and/or other countries. onsemi reserves the right to make changes without further notice to any products herein. onsemi makes no warranty, representation or guarantee regarding the suitability of its products for any particular purpose, nor does onsemi assume any liability arising out of the application or use of any product or circuit, and specifically disclaims any and all liability, including without limitation special, consequential or incidental damages. onsemi does not convey any license under its patent rights nor the rights of others.

# MECHANICAL CASE OUTLINE PACKAGE DIMENSIONS

ON Semiconductor®



TSSOP-20 WB  
CASE 948E  
ISSUE D

DATE 17 FEB 2016

SCALE 2:1



NOTES:

1. DIMENSIONING AND TOLERANCING PER ANSI Y14.5M, 1982.
2. CONTROLLING DIMENSION: MILLIMETER.
3. DIMENSION A DOES NOT INCLUDE MOLD FLASH, PROTRUSIONS OR GATE BURRS. MOLD FLASH OR GATE BURRS SHALL NOT EXCEED 0.15 (0.006) PER SIDE.
4. DIMENSION B DOES NOT INCLUDE INTERLEAD FLASH OR PROTRUSION. INTERLEAD FLASH OR PROTRUSION SHALL NOT EXCEED 0.25 (0.010) PER SIDE.
5. DIMENSION K DOES NOT INCLUDE DAMBAR PROTRUSION. ALLOWABLE DAMBAR PROTRUSION SHALL BE 0.08 (0.003) TOTAL IN EXCESS OF THE K DIMENSION AT MAXIMUM MATERIAL CONDITION.
6. TERMINAL NUMBERS ARE SHOWN FOR REFERENCE ONLY.
7. DIMENSION A AND B ARE TO BE DETERMINED AT DATUM PLANE -W-.

DIM	MILLIMETERS		INCHES	
	MIN	MAX	MIN	MAX
A	6.40	6.60	0.252	0.260
B	4.30	4.50	0.169	0.177
C	---	1.20	---	0.047
D	0.05	0.15	0.002	0.006
F	0.50	0.75	0.020	0.030
G	0.65 BSC		0.026 BSC	
H	0.27	0.37	0.011	0.015
J	0.09	0.20	0.004	0.008
J1	0.09	0.16	0.004	0.006
K	0.19	0.30	0.007	0.012
K1	0.19	0.25	0.007	0.010
L	6.40 BSC		0.252 BSC	
M	0°	8°	0°	8°

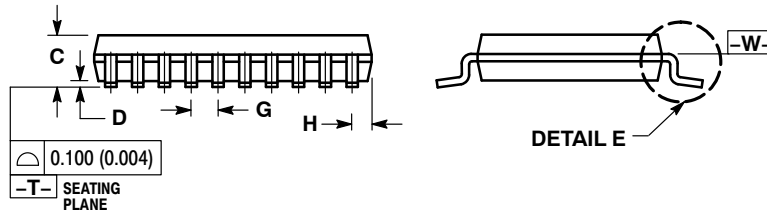

SOLDERING FOOTPRINT



GENERIC MARKING DIAGRAM\*



- A = Assembly Location
- L = Wafer Lot
- Y = Year
- W = Work Week
- = Pb-Free Package

(Note: Microdot may be in either location)

\*This information is generic. Please refer to device data sheet for actual part marking. Pb-Free indicator, "G" or microdot "▪", may or may not be present.

DOCUMENT NUMBER:	98ASH70169A	Electronic versions are uncontrolled except when accessed directly from the Document Repository. Printed versions are uncontrolled except when stamped "CONTROLLED COPY" in red.
DESCRIPTION:	TSSOP-20 WB	PAGE 1 OF 1

ON Semiconductor and ON are trademarks of Semiconductor Components Industries, LLC dba ON Semiconductor or its subsidiaries in the United States and/or other countries. ON Semiconductor reserves the right to make changes without further notice to any products herein. ON Semiconductor makes no warranty, representation or guarantee regarding the suitability of its products for any particular purpose, nor does ON Semiconductor assume any liability arising out of the application or use of any product or circuit, and specifically disclaims any and all liability, including without limitation special, consequential or incidental damages. ON Semiconductor does not convey any license under its patent rights nor the rights of others.

# MECHANICAL CASE OUTLINE

## PACKAGE DIMENSIONS

ON Semiconductor®



TSSOP20, 4.4x6.5  
CASE 948AQ-01  
ISSUE A

DATE 19 MAR 2009

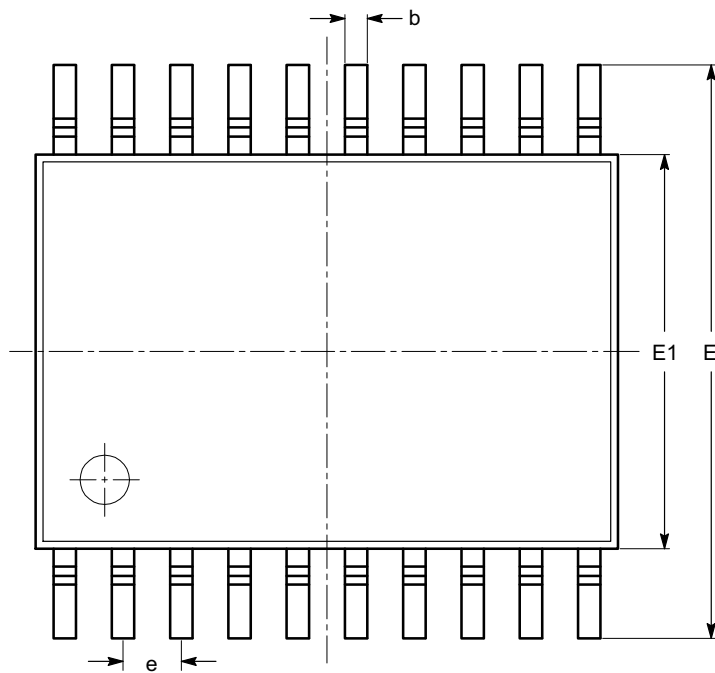

SYMBOL	MIN	NOM	MAX
A			1.20
A1	0.05		0.15
A2	0.80		1.05
b	0.19		0.30
c	0.09		0.20
D	6.40	6.50	6.60
E	6.30	6.40	6.50
E1	4.30	4.40	4.50
e	0.65 BSC		
L	0.45	0.60	0.75
L1	1.00 REF		
$\theta$	0°		8°

TOP VIEW

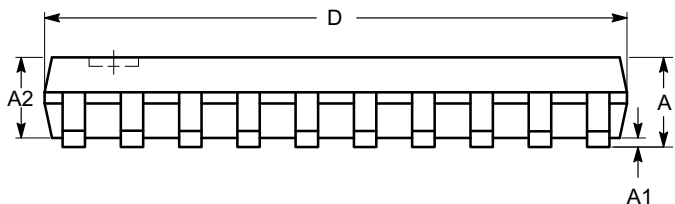

SIDE VIEW

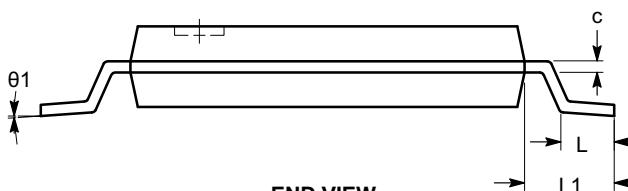

END VIEW

**Notes:**

- (1) All dimensions are in millimeters. Angles in degrees.
- (2) Complies with JEDEC MO-153.

<b>DOCUMENT NUMBER:</b>	<b>98AON34453E</b>	Electronic versions are uncontrolled except when accessed directly from the Document Repository. Printed versions are uncontrolled except when stamped "CONTROLLED COPY" in red.
<b>DESCRIPTION:</b>	<b>TSSOP20, 4.4X6.5</b>	<b>PAGE 1 OF 1</b>

ON Semiconductor and are trademarks of Semiconductor Components Industries, LLC dba ON Semiconductor or its subsidiaries in the United States and/or other countries. ON Semiconductor reserves the right to make changes without further notice to any products herein. ON Semiconductor makes no warranty, representation or guarantee regarding the suitability of its products for any particular purpose, nor does ON Semiconductor assume any liability arising out of the application or use of any product or circuit, and specifically disclaims any and all liability, including without limitation special, consequential or incidental damages. ON Semiconductor does not convey any license under its patent rights nor the rights of others.



**onsemi**, **Onsemi**, and other names, marks, and brands are registered and/or common law trademarks of Semiconductor Components Industries, LLC dba "**onsemi**" or its affiliates and/or subsidiaries in the United States and/or other countries. **onsemi** owns the rights to a number of patents, trademarks, copyrights, trade secrets, and other intellectual property. A listing of **onsemi**'s product/patent coverage may be accessed at [www.onsemi.com/site/pdf/Patent-Marking.pdf](http://www.onsemi.com/site/pdf/Patent-Marking.pdf). **onsemi** reserves the right to make changes at any time to any products or information herein, without notice. The information herein is provided "as-is" and **onsemi** makes no warranty, representation or guarantee regarding the accuracy of the information, product features, availability, functionality, or suitability of its products for any particular purpose, nor does **onsemi** assume any liability arising out of the application or use of any product or circuit, and specifically disclaims any and all liability, including without limitation special, consequential or incidental damages. Buyer is responsible for its products and applications using **onsemi** products, including compliance with all laws, regulations and safety requirements or standards, regardless of any support or applications information provided by **onsemi**. "Typical" parameters which may be provided in **onsemi** data sheets and/or specifications can and do vary in different applications and actual performance may vary over time. All operating parameters, including "Typicals" must be validated for each customer application by customer's technical experts. **onsemi** does not convey any license under any of its intellectual property rights nor the rights of others. **onsemi** products are not designed, intended, or authorized for use as a critical component in life support systems or any FDA Class 3 medical devices or medical devices with a same or similar classification in a foreign jurisdiction or any devices intended for implantation in the human body. Should Buyer purchase or use **onsemi** products for any such unintended or unauthorized application, Buyer shall indemnify and hold **onsemi** and its officers, employees, subsidiaries, affiliates, and distributors harmless against all claims, costs, damages, and expenses, and reasonable attorney fees arising out of, directly or indirectly, any claim of personal injury or death associated with such unintended or unauthorized use, even if such claim alleges that **onsemi** was negligent regarding the design or manufacture of the part. **onsemi** is an Equal Opportunity/Affirmative Action Employer. This literature is subject to all applicable copyright laws and is not for resale in any manner.

## ADDITIONAL INFORMATION

### TECHNICAL PUBLICATIONS:

Technical Library: [www.onsemi.com/design/resources/technical-documentation](http://www.onsemi.com/design/resources/technical-documentation)  
onsemi Website: [www.onsemi.com](http://www.onsemi.com)

### ONLINE SUPPORT: [www.onsemi.com/support](http://www.onsemi.com/support)

For additional information, please contact your local Sales Representative at [www.onsemi.com/support/sales](http://www.onsemi.com/support/sales)

