

Brief Description

ZSPM15xx family ICs are controllers designed for high-current, non-isolated DC/DC step-down point of load (POL) converters. The ZSPM15xx has a digital control loop that is optimized for maximum stability as well as load step and steady-state performance.

ZSPM15xx family ICs have a rich set of integrated fault protection features including over-voltage/under-voltage, output over-current, and over-temperature protections. To facilitate ease of use, the ZSPM15xx is pre-programmed and available for common output voltages. To provide flexibility for the end-customer, the over-current protection threshold and the control loop compensation are selectable by the end-customer to match a number of selected power stages.

ZSPM15xx family ICs have been optimized for maximum efficiency when used with IDT's DrMOS devices. Reference designs and application instructions enable a high performance turnkey solution without extensive engineering development.

Features

- Advanced digital control techniques
 - Tru-sample Technology™
 - State-Law Control™ (SLC)
- Preconfigured compensation for selected inductance values.
- Improved transient response and noise immunity
- Protection features
 - Configuration for over-current protection
 - Over-voltage protection (VIN, VOUT)
 - Under-voltage protection (VIN, VOUT)
 - Over-temperature protection
 - Overloaded startup
 - Restart and delay

Benefits

- Factory pre-configured for industry standard output voltages and currents enabling fast time-to-market
- Simplified design and integration
- FPGA designer-friendly solution
- Highest power density with smallest footprint
- Higher energy efficiency across all output loading conditions
- Operation from a single 5V supply

Available Support

- Reference designs
- Evaluation kits

Physical Characteristics

- Operation temperature: -40°C to +125°C
- VIN for POL application: 10.8V to 13.2V
- VDD50 voltage supply: 4.75 to 5.25V
- Available Output Voltages: 0.85V, 1.0V, 1.2V, 1.5V, 1.8V, 2.0V, 2.5V, 3.3V, and 5.0V
- Lead free (RoHS compliant) 24-pin QFN package (4mm x 4mm)

ZSPM15xx Typical Application Diagram

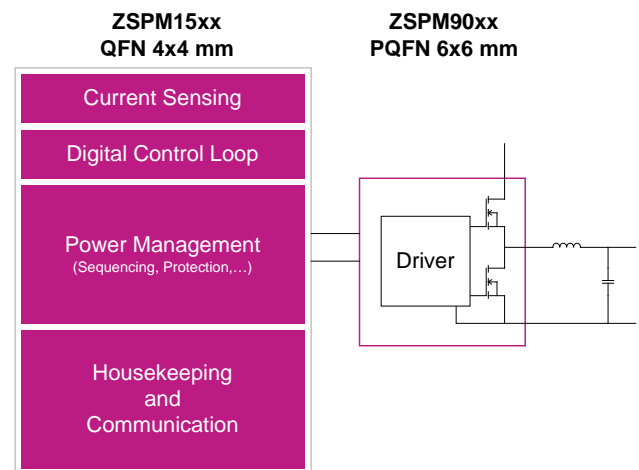

ZSPM15xx Block Diagram

- Typical Applications**
- ❖ Telecom Switches
 - ❖ Servers and Storage
 - ❖ Base Stations
 - ❖ Network Routers
 - ❖ Industrial Applications
 - ❖ Single-Rail/Single-Phase Supplies for Processors, ASICs, FPGAs, DSPs

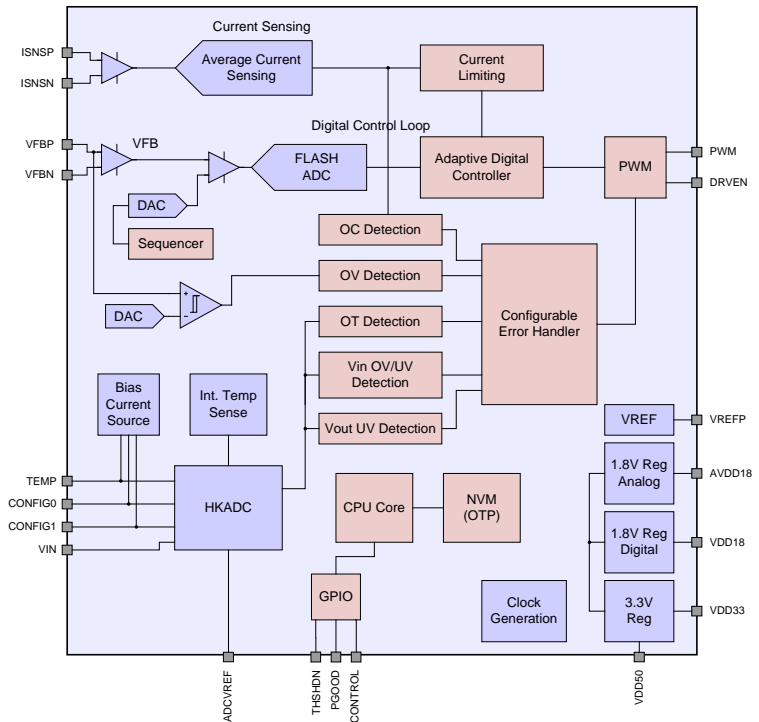

Ordering Information

| Product Code | Description | Package |
|---------------|---|---------|
| ZSPM1501ZA1W0 | ZSPM1501 lead-free QFN24; output voltage: 0.85V; inductance: 330nH; temperature: -40°C to +125°C | Reel |
| ZSPM1502ZA1W0 | ZSPM1502 lead-free QFN24; output voltage: 1.00V; inductance: 330nH; temperature: -40°C to +125°C | Reel |
| ZSPM1503ZA1W0 | ZSPM1503 lead-free QFN24; output voltage: 1.20V; inductance: 330nH; temperature: -40°C to +125°C | Reel |
| ZSPM1504ZA1W0 | ZSPM1504 lead-free QFN24; output voltage: 1.50V; inductance: 470nH; temperature: -40°C to +125°C | Reel |
| ZSPM1505ZA1W0 | ZSPM1505 lead-free QFN24; output voltage: 1.80V; inductance: 470nH; temperature: -40°C to +125°C | Reel |
| ZSPM1506ZA1W0 | ZSPM1506 lead-free QFN24; output voltage: 2.00V; inductance: 470nH; temperature: -40°C to +125°C | Reel |
| ZSPM1507ZA1W0 | ZSPM1507 lead-free QFN24; output voltage: 2.50V; inductance: 1000nH; temperature: -40°C to +125°C | Reel |
| ZSPM1508ZA1W0 | ZSPM1508 lead-free QFN24; output voltage: 3.30V; inductance: 2200nH; temperature: -40°C to +125°C | Reel |
| ZSPM1509ZA1W0 | ZSPM1509 lead-free QFN24; output voltage: 5.00V; inductance: 2200nH; temperature: -40°C to +125°C | Reel |
| ZSPM1511ZA1W0 | ZSPM1511 lead-free QFN24; output voltage: 0.85V; inductance: 680nH; temperature: -40°C to +125°C | Reel |
| ZSPM1512ZA1W0 | ZSPM1512 lead-free QFN24; output voltage: 1.00V; inductance: 680nH; temperature: -40°C to +125°C | Reel |
| ZSPM1513ZA1W0 | ZSPM1513 lead-free QFN24; output voltage: 1.20V; inductance: 680nH; temperature: -40°C to +125°C | Reel |

Contents

| | | |
|---------|---|----|
| 1 | IC Characteristics | 14 |
| 1.1. | Absolute Maximum Ratings | 14 |
| 1.2. | Recommended Operating Conditions | 15 |
| 1.3. | Electrical Parameters | 15 |
| 1.4. | Device-Specific System Parameters | 18 |
| 1.4.1. | ZSPM1501 | 18 |
| 1.4.2. | ZSPM1502 | 18 |
| 1.4.3. | ZSPM1503 | 19 |
| 1.4.4. | ZSPM1504 | 20 |
| 1.4.5. | ZSPM1505 | 20 |
| 1.4.6. | ZSPM1506 | 21 |
| 1.4.7. | ZSPM1507 | 22 |
| 1.4.8. | ZSPM1508 | 22 |
| 1.4.9. | ZSPM1509 | 23 |
| 1.4.10. | ZSPM1511 | 23 |
| 1.4.11. | ZSPM1512 | 24 |
| 1.4.12. | ZSPM1513 | 24 |
| 2 | Product Summary..... | 25 |
| 2.1. | Overview..... | 25 |
| 2.2. | Pin Description..... | 27 |
| 2.3. | Available Packages | 28 |
| 3 | Functional Description..... | 29 |
| 3.1. | Power Supply Circuitry, Reference Decoupling, and Grounding | 29 |
| 3.2. | Reset/Start-up Behavior | 29 |
| 3.3. | Digital Power Control..... | 29 |
| 3.3.1. | Overview | 29 |
| 3.3.2. | Output Voltage Feedback | 29 |
| 3.3.3. | Digital Compensator | 30 |
| 3.3.4. | Power Sequencing and the CONTROL Pin..... | 31 |
| 3.4. | Fault Monitoring and Response Generation..... | 32 |
| 3.4.1. | Output Over/Under-Voltage | 32 |
| 3.4.2. | Output Current Protection | 32 |
| 3.4.3. | Input Voltage Protection..... | 33 |
| 3.4.4. | Over-Temperature Protection | 33 |
| 4 | Application Information..... | 34 |
| 4.1. | Application Schematic | 34 |
| 4.2. | Device-Specific Passive Components..... | 36 |
| 4.3. | Output Voltage Feedback Components | 38 |

| | | |
|-------|--|----|
| 4.4. | DCR Current Sensing Components | 38 |
| 4.5. | Input Voltage Sensing | 39 |
| 4.6. | External Temperature Sensing..... | 39 |
| 4.7. | CONFIG0 – Over-Current Protection Threshold | 40 |
| 4.8. | CONFIG1 – Compensation Loop and Output Voltage Slew Rate..... | 41 |
| 5 | Typical Performance Data..... | 46 |
| 5.1. | ZSPM1501 – Typical Load Transient Response – Capacitor Range #1 – Comp0..... | 47 |
| 5.2. | ZSPM1501 – Typical Load Transient Response – Capacitor Range #2 – Comp1..... | 48 |
| 5.3. | ZSPM1501 – Typical Load Transient Response – Capacitor Range #3 – Comp2..... | 49 |
| 5.4. | ZSPM1501 – Typical Load Transient Response – Capacitor Range #4 – Comp3..... | 50 |
| 5.5. | ZSPM1502 – Typical Load Transient Response – Capacitor Range #1 – Comp0..... | 51 |
| 5.6. | ZSPM1502 – Typical Load Transient Response – Capacitor Range #2 – Comp1..... | 52 |
| 5.7. | ZSPM1502 – Typical Load Transient Response – Capacitor Range #3 – Comp2..... | 53 |
| 5.8. | ZSPM1502 – Typical Load Transient Response – Capacitor Range #4 – Comp3..... | 54 |
| 5.9. | ZSPM1503 – Typical Load Transient Response – Capacitor Range #1 – Comp0..... | 55 |
| 5.10. | ZSPM1503 – Typical Load Transient Response – Capacitor Range #2 – Comp1..... | 56 |
| 5.11. | ZSPM1503 – Typical Load Transient Response – Capacitor Range #3 – Comp2..... | 57 |
| 5.12. | ZSPM1503 – Typical Load Transient Response – Capacitor Range #4 – Comp3..... | 58 |
| 5.13. | ZSPM1504 – Typical Load Transient Response – Capacitor Range #1 – Comp0..... | 59 |
| 5.14. | ZSPM1504 – Typical Load Transient Response – Capacitor Range #2 – Comp1..... | 60 |
| 5.15. | ZSPM1504 – Typical Load Transient Response – Capacitor Range #3 – Comp2..... | 61 |
| 5.16. | ZSPM1504 – Typical Load Transient Response – Capacitor Range #4 – Comp3..... | 62 |
| 5.17. | ZSPM1505 – Typical Load Transient Response – Capacitor Range #1 – Comp0..... | 63 |
| 5.18. | ZSPM1505 – Typical Load Transient Response – Capacitor Range #2 – Comp1..... | 64 |
| 5.19. | ZSPM1505 – Typical Load Transient Response – Capacitor Range #3 – Comp2..... | 65 |
| 5.20. | ZSPM1505 – Typical Load Transient Response – Capacitor Range #4 – Comp3..... | 66 |
| 5.21. | ZSPM1506 – Typical Load Transient Response – Capacitor Range #1 – Comp0..... | 67 |
| 5.22. | ZSPM1506 – Typical Load Transient Response – Capacitor Range #2 – Comp1..... | 68 |
| 5.23. | ZSPM1506 – Typical Load Transient Response – Capacitor Range #3 – Comp2..... | 69 |
| 5.24. | ZSPM1506 – Typical Load Transient Response – Capacitor Range #4 – Comp3..... | 70 |
| 5.25. | ZSPM1507 – Typical Load Transient Response –Capacitor Range 1 – Comp0..... | 71 |
| 5.26. | ZSPM1507 – Typical Load Transient Response –Capacitor Range 2 – Comp1..... | 72 |
| 5.27. | ZSPM1507 – Typical Load Transient Response –Capacitor Range 3 – Comp2..... | 73 |
| 5.28. | ZSPM1507 – Typical Load Transient Response –Capacitor Range 4 – Comp3..... | 74 |
| 5.29. | ZSPM1508 – Typical Load Transient Response –Capacitor Range 1 – Comp0..... | 75 |
| 5.30. | ZSPM1508 – Typical Load Transient Response –Capacitor Range 2 – Comp1..... | 76 |
| 5.31. | ZSPM1508 – Typical Load Transient Response –Capacitor Range 3 – Comp2..... | 77 |
| 5.32. | ZSPM1508 – Typical Load Transient Response –Capacitor Range 4 – Comp3..... | 78 |
| 5.33. | ZSPM1509 – Typical Load Transient Response –Capacitor Range 1 – Comp0..... | 79 |

| | | |
|-------|---|-----|
| 5.34. | ZSPM1509 – Typical Load Transient Response –Capacitor Range 2 – Comp1..... | 80 |
| 5.35. | ZSPM1509 – Typical Load Transient Response –Capacitor Range 3 – Comp2..... | 81 |
| 5.36. | ZSPM1509 – Typical Load Transient Response –Capacitor Range 4 – Comp3..... | 82 |
| 5.37. | ZSPM1511 – Typical Load Transient Response – Capacitor Range #1 – Comp0..... | 83 |
| 5.38. | ZSPM1511 – Typical Load Transient Response – Capacitor Range #2 – Comp1..... | 84 |
| 5.39. | ZSPM1511 – Typical Load Transient Response – Capacitor Range #3 – Comp2..... | 85 |
| 5.40. | ZSPM1511 – Typical Load Transient Response – Capacitor Range #4 – Comp3..... | 86 |
| 5.41. | ZSPM1512 – Typical Load Transient Response – Capacitor Range #1 – Comp0..... | 87 |
| 5.42. | ZSPM1512 – Typical Load Transient Response – Capacitor Range #2 – Comp1..... | 88 |
| 5.43. | ZSPM1512 – Typical Load Transient Response – Capacitor Range #3 – Comp2..... | 89 |
| 5.44. | ZSPM1512 – Typical Load Transient Response – Capacitor Range #4 – Comp3..... | 90 |
| 5.45. | ZSPM1513 – Typical Load Transient Response – Capacitor Range #1 – Comp0..... | 91 |
| 5.46. | ZSPM1513 – Typical Load Transient Response – Capacitor Range #2 – Comp1..... | 92 |
| 5.47. | ZSPM1513 – Typical Load Transient Response – Capacitor Range #3 – Comp2..... | 93 |
| 5.48. | ZSPM1513 – Typical Load Transient Response – Capacitor Range #4 – Comp3..... | 94 |
| 5.49. | Typical Efficiency Curves – ZSPM1502 with ZSPM9000, ZSPM9015, and ZSPM9060 DrMOS | 95 |
| 5.50. | Typical Efficiency Curves – ZSPM9000 DrMOS with ZSPM1504, ZSPM1505, and ZSPM1506 | 96 |
| 5.51. | Typical Efficiency Curves – ZSPM9000 and ZSPM9060 DrMOS with ZSPM1508 and ZSPM1509 | 97 |
| 5.52. | Typical Efficiency Curves – ZSPM9000 and ZSPM9060 DrMOS with ZSPM1511, ZSPM1512, and ZSPM1513..... | 98 |
| 6 | Mechanical Specifications..... | 99 |
| 7 | Ordering Information | 100 |
| 8 | Related Documents..... | 100 |
| 9 | Glossary | 101 |
| 10 | Document Revision History..... | 101 |

List of Figures

| | | |
|------------|---|----|
| Figure 2.1 | Typical Application Circuit with a 5V Supply Voltage..... | 25 |
| Figure 2.2 | Block Diagram | 26 |
| Figure 2.3 | Pin-out QFN24 Package | 28 |
| Figure 3.1 | Simplified Block Diagram of the Digital Compensation..... | 30 |
| Figure 3.2 | Power Sequencing..... | 31 |
| Figure 4.1 | ZSPM15xx – Application Circuit with a 5V Supply Voltage | 34 |
| Figure 4.2 | Output Voltage Sense Circuitry..... | 38 |
| Figure 4.3 | Inductor Current Sensing Using the DCR Method..... | 38 |
| Figure 4.4 | Input Voltage Sense Circuitry..... | 39 |
| Figure 4.5 | External Temperature Sense Circuitry..... | 39 |
| Figure 5.1 | ZSPM1501 with Comp0; 5A to 15A Load Step; and Min. Capacitance..... | 47 |

| | | |
|-------------|---|----|
| Figure 5.2 | ZSPM1501 with Comp0; 15A to 5A Load Step; and Min. Capacitance..... | 47 |
| Figure 5.3 | ZSPM1501 with Comp0; 5A to 15A Load Step; and Max. Capacitance..... | 47 |
| Figure 5.4 | ZSPM1501 with Comp0; 15A to 5A Load Step; and Max. Capacitance..... | 47 |
| Figure 5.5 | Open Loop Bode Plots for ZSPM1501 with Comp0..... | 47 |
| Figure 5.6 | ZSPM1501 with Comp1; 5A to 15A Load Step; and Min. Capacitance..... | 48 |
| Figure 5.7 | ZSPM1501 with Comp1; 15A to 5A Load Step; and Min. Capacitance..... | 48 |
| Figure 5.8 | ZSPM1501 with Comp1; 5A to 15A Load Step; and Max. Capacitance..... | 48 |
| Figure 5.9 | ZSPM1501 with Comp1; 15A to 5A Load Step; and Max. Capacitance..... | 48 |
| Figure 5.10 | Open Loop Bode Plots for ZSPM1501 with Comp1..... | 48 |
| Figure 5.11 | ZSPM1501 with Comp2; 5A to 15A Load Step; and Min. Capacitance..... | 49 |
| Figure 5.12 | ZSPM1501 with Comp2; 15A to 5A Load Step; and Min. Capacitance..... | 49 |
| Figure 5.13 | ZSPM1501 with Comp2; 5A to 15A Load Step; and Max. Capacitance..... | 49 |
| Figure 5.14 | ZSPM1501 with Comp2; 15A to 5A Load Step; and Max. Capacitance..... | 49 |
| Figure 5.15 | Open Loop Bode Plots for ZSPM1501 with Comp2..... | 49 |
| Figure 5.16 | ZSPM1501 with Comp3; 5A to 15A Load Step; and Min. Capacitance..... | 50 |
| Figure 5.17 | ZSPM1501 with Comp3; 15A to 5A Load Step; and Min. Capacitance..... | 50 |
| Figure 5.18 | ZSPM1501 with Comp3; 5A to 15A Load Step; and Max. Capacitance..... | 50 |
| Figure 5.19 | ZSPM1501 with Comp3; 15A to 5A Load Step; and Max. Capacitance..... | 50 |
| Figure 5.20 | Open Loop Bode Plots for ZSPM1501 with Comp3..... | 50 |
| Figure 5.21 | ZSPM1502 with Comp0; 5A to 15A Load Step; and Min. Capacitance..... | 51 |
| Figure 5.22 | ZSPM1502 with Comp0; 15A to 5A Load Step; and Min. Capacitance..... | 51 |
| Figure 5.23 | ZSPM1502 with Comp0; 5A to 15A Load Step; and Max. Capacitance..... | 51 |
| Figure 5.24 | ZSPM1502 with Comp0; 15A to 5A Load Step; and Max. Capacitance..... | 51 |
| Figure 5.25 | Open Loop Bode Plots for ZSPM1502 with Comp0..... | 51 |
| Figure 5.26 | ZSPM1502 with Comp1; 5A to 15A Load Step; and Min. Capacitance..... | 52 |
| Figure 5.27 | ZSPM1502 with Comp1; 15A to 5A Load Step; and Min. Capacitance..... | 52 |
| Figure 5.28 | ZSPM1502 with Comp1; 5A to 15A Load Step; and Max. Capacitance..... | 52 |
| Figure 5.29 | ZSPM1502 with Comp1; 15A to 5A Load Step; and Max. Capacitance..... | 52 |
| Figure 5.30 | Open Loop Bode Plots for ZSPM1502 with Comp1..... | 52 |
| Figure 5.31 | ZSPM1502 with Comp2; 5A to 15A Load Step; and Min. Capacitance..... | 53 |
| Figure 5.32 | ZSPM1502 with Comp2; 15A to 5A Load Step; and Min. Capacitance..... | 53 |
| Figure 5.33 | ZSPM1502 with Comp2; 5A to 15A Load Step; and Max. Capacitance..... | 53 |
| Figure 5.34 | ZSPM1502 with Comp2; 15A to 5A Load Step; and Max. Capacitance..... | 53 |
| Figure 5.35 | Open Loop Bode Plots for ZSPM1502 with Comp2..... | 53 |
| Figure 5.36 | ZSPM1502 with Comp3; 5A to 15A Load Step; and Min. Capacitance..... | 54 |
| Figure 5.37 | ZSPM1502 with Comp3; 15A to 5A Load Step; and Min. Capacitance..... | 54 |
| Figure 5.38 | ZSPM1502 with Comp3; 5A to 15A Load Step; and Max. Capacitance..... | 54 |
| Figure 5.39 | ZSPM1502 with Comp3; 15A to 5A Load Step; and Max. Capacitance..... | 54 |
| Figure 5.40 | Open Loop Bode Plots for ZSPM1502 with Comp3..... | 54 |

| | | |
|-------------|---|----|
| Figure 5.41 | ZSPM1503 with Comp0; 5A to 15A Load Step; and Min. Capacitance..... | 55 |
| Figure 5.42 | ZSPM1503 with Comp0; 15A to 5A Load Step; and Min. Capacitance..... | 55 |
| Figure 5.43 | ZSPM1503 with Comp0; 5A to 15A Load Step; and Max. Capacitance..... | 55 |
| Figure 5.44 | ZSPM1503 with Comp0; 15A to 5A Load Step; and Max. Capacitance..... | 55 |
| Figure 5.45 | Open Loop Bode Plots for ZSPM1503 with Comp0..... | 55 |
| Figure 5.46 | ZSPM1503 with Comp1; 5A to 15A Load Step; and Min. Capacitance..... | 56 |
| Figure 5.47 | ZSPM1503 with Comp1; 15A to 5A Load Step; and Min. Capacitance..... | 56 |
| Figure 5.48 | ZSPM1503 with Comp1; 5 to 15A Load Step; and Max. Capacitance | 56 |
| Figure 5.49 | ZSPM1503 with Comp1; 15 to 5A Load Step; and Max. Capacitance | 56 |
| Figure 5.50 | Open Loop Bode Plots for ZSPM1503 with Comp1..... | 56 |
| Figure 5.51 | ZSPM1503 with Comp2; 5A to 15A Load Step; and Min. Capacitance..... | 57 |
| Figure 5.52 | ZSPM1503 with Comp2; 15A to 5A Load Step; and Min. Capacitance..... | 57 |
| Figure 5.53 | ZSPM1503 with Comp2; 5A to 15A Load Step; and Max. Capacitance..... | 57 |
| Figure 5.54 | ZSPM1503 with Comp2; 15A to 5A Load Step; and Max. Capacitance..... | 57 |
| Figure 5.55 | Open Loop Bode Plots for ZSPM1503 with Comp2..... | 57 |
| Figure 5.56 | ZSPM1503 with Comp3; 5A to 15A Load Step; and Min. Capacitance..... | 58 |
| Figure 5.57 | ZSPM1503 with Comp3; 15A to 5A Load Step; and Min. Capacitance..... | 58 |
| Figure 5.58 | ZSPM1503 with Comp3; 5A to 15A Load Step; and Max. Capacitance..... | 58 |
| Figure 5.59 | ZSPM1503 with Comp3; 15A to 5A Load Step; and Max. Capacitance..... | 58 |
| Figure 5.60 | Open Loop Bode Plots for ZSPM1503 with Comp3..... | 58 |
| Figure 5.61 | ZSPM1504 with Comp0; 5A to 15A Load Step; and Min. Capacitance..... | 59 |
| Figure 5.62 | ZSPM1504 with Comp0; 15A to 5A Load Step; and Min. Capacitance..... | 59 |
| Figure 5.63 | ZSPM1504 with Comp0; 5A to 15A Load Step; and Max. Capacitance..... | 59 |
| Figure 5.64 | ZSPM1504 with Comp0; 15A to 5A Load Step; and Max. Capacitance..... | 59 |
| Figure 5.65 | Open Loop Bode Plots for ZSPM1504 with Comp0..... | 59 |
| Figure 5.66 | ZSPM1504 with Comp1; 5A to 15A Load Step; and Min. Capacitance..... | 60 |
| Figure 5.67 | ZSPM1504 with Comp1; 15A to 5A Load Step; and Min. Capacitance..... | 60 |
| Figure 5.68 | ZSPM1504 with Comp1; 5A to 15A Load Step; and Max. Capacitance..... | 60 |
| Figure 5.69 | ZSPM1504 with Comp1; 15A to 5A Load Step; and Max. Capacitance..... | 60 |
| Figure 5.70 | Open Loop Bode Plots for ZSPM1504 with Comp1..... | 60 |
| Figure 5.71 | ZSPM1504 with Comp2; 5A to 15A Load Step; and Min. Capacitance..... | 61 |
| Figure 5.72 | ZSPM1504 with Comp2; 15A to 5A Load Step; and Min. Capacitance..... | 61 |
| Figure 5.73 | ZSPM1504 with Comp2; 5A to 15A Load Step; and Max. Capacitance..... | 61 |
| Figure 5.74 | ZSPM1504 with Comp2; 15A to 5A Load Step; and Max. Capacitance..... | 61 |
| Figure 5.75 | Open Loop Bode Plots for ZSPM1504 with Comp2..... | 61 |
| Figure 5.76 | ZSPM1504 with Comp3; 5A to 15A Load Step; and Min. Capacitance..... | 62 |
| Figure 5.77 | ZSPM1504 with Comp3; 15A to 5A Load Step; and Min. Capacitance..... | 62 |
| Figure 5.78 | ZSPM1504 with Comp3; 5A to 15A Load Step; and Max. Capacitance..... | 62 |
| Figure 5.79 | ZSPM1504 with Comp3; 15A to 5A Load Step; and Max. Capacitance..... | 62 |

| | | |
|--------------|---|----|
| Figure 5.80 | Open Loop Bode Plots for ZSPM1504 with Comp3..... | 62 |
| Figure 5.81 | ZSPM1505 with Comp0; 5A to 15A Load Step; and Min. Capacitance..... | 63 |
| Figure 5.82 | ZSPM1505 with Comp0; 15A to 5A Load Step; and Min. Capacitance..... | 63 |
| Figure 5.83 | ZSPM1505 with Comp0; 5A to 15A Load Step; and Max. Capacitance..... | 63 |
| Figure 5.84 | ZSPM1505 with Comp0; 15A to 5A Load Step; and Max. Capacitance..... | 63 |
| Figure 5.85 | Open Loop Bode Plots for ZSPM1505 with Comp0..... | 63 |
| Figure 5.86 | ZSPM1505 with Comp1; 5A to 15A Load Step; and Min. Capacitance..... | 64 |
| Figure 5.87 | ZSPM1505 with Comp1; 15A to 5A Load Step; and Min. Capacitance..... | 64 |
| Figure 5.88 | ZSPM1505 with Comp1; 5A to 15A Load Step; and Max. Capacitance..... | 64 |
| Figure 5.89 | ZSPM1505 with Comp1; 15A to 5A Load Step; and Max. Capacitance..... | 64 |
| Figure 5.90 | Open Loop Bode Plots for ZSPM1505 with Comp1..... | 64 |
| Figure 5.91 | ZSPM1505 with Comp2; 5A to 15A Load Step; and Min. Capacitance..... | 65 |
| Figure 5.92 | ZSPM1505 with Comp2; 15A to 5A Load Step; and Min. Capacitance..... | 65 |
| Figure 5.93 | ZSPM1505 with Comp2; 5A to 15A Load Step; and Max. Capacitance..... | 65 |
| Figure 5.94 | ZSPM1505 with Comp2; 15A to 5A Load Step; and Max. Capacitance..... | 65 |
| Figure 5.95 | Open Loop Bode Plots for ZSPM1505 with Comp2..... | 65 |
| Figure 5.96 | ZSPM1505 with Comp3; 5A to 15A Load Step; and Min. Capacitance..... | 66 |
| Figure 5.97 | ZSPM1505 with Comp3; 15A to 5A Load Step; and Min. Capacitance..... | 66 |
| Figure 5.98 | ZSPM1505 with Comp3; 5A to 15A Load Step; and Max. Capacitance..... | 66 |
| Figure 5.99 | ZSPM1505 with Comp3; 15A to 5A Load Step; and Max. Capacitance..... | 66 |
| Figure 5.100 | Open Loop Bode Plots for ZSPM1505 with Comp3..... | 66 |
| Figure 5.101 | ZSPM1506 with Comp0; 5A to 15A Load Step; and Min. Capacitance..... | 67 |
| Figure 5.102 | ZSPM1506 with Comp0; 15A to 5A Load Step; and Min. Capacitance..... | 67 |
| Figure 5.103 | ZSPM1506 with Comp0; 5A to 15A Load Step; and Max. Capacitance..... | 67 |
| Figure 5.104 | ZSPM1506 with Comp0; 15A to 5A Load Step; and Max. Capacitance..... | 67 |
| Figure 5.105 | Open Loop Bode Plots for ZSPM1506 with Comp0..... | 67 |
| Figure 5.106 | ZSPM1506 with Comp1; 5A to 15A Load Step; and Min. Capacitance..... | 68 |
| Figure 5.107 | ZSPM1506 with Comp1; 15A to 5A Load Step; and Min. Capacitance..... | 68 |
| Figure 5.108 | ZSPM1506 with Comp1; 5A to 15A Load Step; and Max. Capacitance..... | 68 |
| Figure 5.109 | ZSPM1506 with Comp1; 15A to 5A Load Step; and Max. Capacitance..... | 68 |
| Figure 5.110 | Open Loop Bode Plots for ZSPM1506 with Comp1..... | 68 |
| Figure 5.111 | ZSPM1506 with Comp2; 5A to 15A Load Step; and Min. Capacitance..... | 69 |
| Figure 5.112 | ZSPM1506 with Comp2; 15A to 5A Load Step; and Min. Capacitance..... | 69 |
| Figure 5.113 | ZSPM1506 with Comp2; 5A to 15A Load Step; and Max. Capacitance..... | 69 |
| Figure 5.114 | ZSPM1506 with Comp2; 15A to 5A Load Step; and Max. Capacitance..... | 69 |
| Figure 5.115 | Open Loop Bode Plots for ZSPM1506 with Comp2..... | 69 |
| Figure 5.116 | ZSPM1506 with Comp3; 5A to 15A Load Step; and Min. Capacitance..... | 70 |
| Figure 5.117 | ZSPM1506 with Comp3; 15A to 5A Load Step; and Min. Capacitance..... | 70 |

| | | |
|--------------|---|----|
| Figure 5.118 | ZSPM1506 with Comp3; 5A to 15A Load Step; and Max. Capacitance..... | 70 |
| Figure 5.119 | ZSPM1506 with Comp3; 15A to 5A Load Step; and Max. Capacitance..... | 70 |
| Figure 5.120 | Open Loop Bode Plots for ZSPM1506 with Comp3..... | 70 |
| Figure 5.121 | ZSPM1507 with Comp0; 5 to 15A Load Step; and Min. Capacitance | 71 |
| Figure 5.122 | ZSPM1507 with Comp0; 15 to 5A Load Step; and Min. Capacitance | 71 |
| Figure 5.123 | ZSPM1507 with Comp0; 5 to 15A Load Step; and Max. Capacitance | 71 |
| Figure 5.124 | ZSPM1507 with Comp0; 15 to 5A Load Step; and Max. Capacitance | 71 |
| Figure 5.125 | Open Loop Bode Plots for ZSPM1507 with Comp0..... | 71 |
| Figure 5.126 | ZSPM1507 with Comp1; 5 to 15A Load Step; and Min. Capacitance | 72 |
| Figure 5.127 | ZSPM1507 with Comp1; 15 to 5A Load Step; and Min. Capacitance | 72 |
| Figure 5.128 | ZSPM1507 with Comp1; 5 to 15A Load Step; and Max. Capacitance | 72 |
| Figure 5.129 | ZSPM1507 with Comp1; 15 to 5A Load Step; and Max. Capacitance | 72 |
| Figure 5.130 | Open Loop Bode Plots for ZSPM1507 with Comp1..... | 72 |
| Figure 5.131 | ZSPM1507 with Comp2; 5 to 15A Load Step; and Min. Capacitance | 73 |
| Figure 5.132 | ZSPM1507 with Comp2; 15 to 5A Load Step; and Min. Capacitance | 73 |
| Figure 5.133 | ZSPM1507 with Comp2; 5 to 15A Load Step; and Max. Capacitance | 73 |
| Figure 5.134 | ZSPM1507 with Comp2; 15 to 5A Load Step; and Max. Capacitance | 73 |
| Figure 5.135 | Open Loop Bode Plots for ZSPM1507 with Comp2..... | 73 |
| Figure 5.136 | ZSPM1507 with Comp3; 5 to 15A Load Step; and Min. Capacitance | 74 |
| Figure 5.137 | ZSPM1507 with Comp3; 15 to 5A Load Step; and Min. Capacitance | 74 |
| Figure 5.138 | ZSPM1507 with Comp3; 5 to 15A Load Step; and Max. Capacitance | 74 |
| Figure 5.139 | ZSPM1507 with Comp3; 15 to 5A Load Step; and Max. Capacitance | 74 |
| Figure 5.140 | Open Loop Bode Plots for ZSPM1507 with Comp3..... | 74 |
| Figure 5.141 | ZSPM1508 with Comp0; 5A to 10A Load Step; and Min. Capacitance..... | 75 |
| Figure 5.142 | ZSPM1508 with Comp0; 10A to 5A Load Step; and Min. Capacitance..... | 75 |
| Figure 5.143 | ZSPM1508 with Comp0; 5A to 10A Load Step; and Max. Capacitance..... | 75 |
| Figure 5.144 | ZSPM1508 with Comp0; 10A to 5A Load Step; and Max. Capacitance..... | 75 |
| Figure 5.145 | Open Loop Bode Plots for ZSPM1508 with Comp0..... | 75 |
| Figure 5.146 | ZSPM1508 with Comp1; 5A to 10A Load Step; and Min. Capacitance..... | 76 |
| Figure 5.147 | ZSPM1508 with Comp1; 10A to 5A Load Step; and Min. Capacitance..... | 76 |
| Figure 5.148 | ZSPM1508 with Comp1; 5A to 10A Load Step; and Max. Capacitance..... | 76 |
| Figure 5.149 | ZSPM1508 with Comp1; 10A to 5A Load Step; and Max. Capacitance..... | 76 |
| Figure 5.150 | Open Loop Bode Plots for ZSPM1508 with Comp1..... | 76 |
| Figure 5.151 | ZSPM1508 with Comp2; 5A to 10A Load Step; and Min. Capacitance..... | 77 |
| Figure 5.152 | ZSPM1508 with Comp2; 10A to 5A Load Step; and Min. Capacitance..... | 77 |
| Figure 5.153 | ZSPM1508 with Comp2; 5A to 10A Load Step; and Max. Capacitance..... | 77 |
| Figure 5.154 | ZSPM1508 with Comp2; 10A to 5A Load Step; and Max. Capacitance..... | 77 |
| Figure 5.155 | Open Loop Bode Plots for ZSPM1508 with Comp2..... | 77 |
| Figure 5.156 | ZSPM1508 with Comp3; 5A to 10A Load Step; and Min. Capacitance..... | 78 |

| | | |
|--------------|---|----|
| Figure 5.157 | ZSPM1508 with Comp3; 10A to 5A Load Step; and Min. Capacitance..... | 78 |
| Figure 5.158 | ZSPM1508 with Comp3; 5A to 10A Load Step; and Max. Capacitance..... | 78 |
| Figure 5.159 | ZSPM1508 with Comp3; 10A to 5A Load Step; and Max. Capacitance..... | 78 |
| Figure 5.160 | Open Loop Bode Plots for ZSPM1508 with Comp3..... | 78 |
| Figure 5.161 | ZSPM1509 with Comp0; 3A to 8A Load Step; and Min. Capacitance..... | 79 |
| Figure 5.162 | ZSPM1509 with Comp0; 8A to 3A Load Step; and Min. Capacitance..... | 79 |
| Figure 5.163 | ZSPM1509 with Comp0; 3A to 8A Load Step; and Max. Capacitance..... | 79 |
| Figure 5.164 | ZSPM1509 with Comp0; 8A to 3A Load Step; and Max. Capacitance..... | 79 |
| Figure 5.165 | Open Loop Bode Plots for ZSPM1509 with Comp0..... | 79 |
| Figure 5.166 | ZSPM1509 with Comp1; 3A to 8A Load Step; and Min. Capacitance..... | 80 |
| Figure 5.167 | ZSPM1509 with Comp1; 8A to 3A Load Step; and Min. Capacitance..... | 80 |
| Figure 5.168 | ZSPM1509 with Comp1; 3A to 8A Load Step; and Max. Capacitance..... | 80 |
| Figure 5.169 | ZSPM1509 with Comp1; 8A to 3A Load Step; and Max. Capacitance..... | 80 |
| Figure 5.170 | Open Loop Bode Plots for ZSPM1509 with Comp1..... | 80 |
| Figure 5.171 | ZSPM1509 with Comp2; 3A to 8A Load Step; and Min. Capacitance..... | 81 |
| Figure 5.172 | ZSPM1509 with Comp2; 8A to 3A Load Step; and Min. Capacitance..... | 81 |
| Figure 5.173 | ZSPM1509 with Comp2; 3A to 8A Load Step; and Max. Capacitance..... | 81 |
| Figure 5.174 | ZSPM1509 with Comp2; 8A to 3A Load Step; and Max. Capacitance..... | 81 |
| Figure 5.175 | Open Loop Bode Plots for ZSPM1509 with Comp2..... | 81 |
| Figure 5.176 | ZSPM1509 with Comp3; 3A to 8A Load Step; and Min. Capacitance..... | 82 |
| Figure 5.177 | ZSPM1509 with Comp3; 8A to 3A Load Step; and Min. Capacitance..... | 82 |
| Figure 5.178 | ZSPM1509 with Comp3; 3A to 8A Load Step; and Max. Capacitance..... | 82 |
| Figure 5.179 | ZSPM1509 with Comp3; 8A to 3A Load Step; and Max. Capacitance..... | 82 |
| Figure 5.180 | Open Loop Bode Plots for ZSPM1509 with Comp3..... | 82 |
| Figure 5.181 | ZSPM1511 with Comp0; 5A to 15A Load Step; and Min. Capacitance..... | 83 |
| Figure 5.182 | ZSPM1511 with Comp0; 15A to 5A Load Step; and Min. Capacitance..... | 83 |
| Figure 5.183 | ZSPM1511 with Comp0; 5A to 15A Load Step; and Max. Capacitance..... | 83 |
| Figure 5.184 | ZSPM1511 with Comp0; 15A to 5A Load Step; and Max. Capacitance..... | 83 |
| Figure 5.185 | Open Loop Bode Plots for ZSPM1511 with Comp0..... | 83 |
| Figure 5.186 | ZSPM1511 with Comp1; 5A to 15A Load Step; and Min. Capacitance..... | 84 |
| Figure 5.187 | ZSPM1511 with Comp1; 15A to 5A Load Step; and Min. Capacitance..... | 84 |
| Figure 5.188 | ZSPM1511 with Comp1; 5A to 15A Load Step; and Max. Capacitance..... | 84 |
| Figure 5.189 | ZSPM1511 with Comp1; 15A to 5A Load Step; and Max. Capacitance..... | 84 |
| Figure 5.190 | Open Loop Bode Plots for ZSPM1511 with Comp1..... | 84 |
| Figure 5.191 | ZSPM1511 with Comp2; 5A to 15A Load Step; and Min. Capacitance..... | 85 |
| Figure 5.192 | ZSPM1511 with Comp2; 15A to 5A Load Step; and Min. Capacitance..... | 85 |
| Figure 5.193 | ZSPM1511 with Comp2; 5A to 15A Load Step; and Max. Capacitance..... | 85 |
| Figure 5.194 | ZSPM1511 with Comp2; 15A to 5A Load Step; and Max. Capacitance..... | 85 |
| Figure 5.195 | Open Loop Bode Plots for ZSPM1511 with Comp2..... | 85 |

| | | |
|--------------|---|----|
| Figure 5.196 | ZSPM1511 with Comp3; 5A to 15A Load Step; and Min. Capacitance..... | 86 |
| Figure 5.197 | ZSPM1511 with Comp3; 15A to 5A Load Step; and Min. Capacitance..... | 86 |
| Figure 5.198 | ZSPM1511 with Comp3; 5A to 15A Load Step; and Max. Capacitance..... | 86 |
| Figure 5.199 | ZSPM1511 with Comp3; 15A to 5A Load Step; and Max. Capacitance..... | 86 |
| Figure 5.200 | Open Loop Bode Plots for ZSPM1511 with Comp3..... | 86 |
| Figure 5.201 | ZSPM1512 with Comp0; 5A to 15A Load Step; and Min. Capacitance..... | 87 |
| Figure 5.202 | ZSPM1512 with Comp0; 15A to 5A Load Step; and Min. Capacitance..... | 87 |
| Figure 5.203 | ZSPM1512 with Comp0; 5A to 15A Load Step; and Max. Capacitance..... | 87 |
| Figure 5.204 | ZSPM1512 with Comp0; 15A to 5A Load Step; and Max. Capacitance..... | 87 |
| Figure 5.205 | Open Loop Bode Plots for ZSPM1512 with Comp0..... | 87 |
| Figure 5.206 | ZSPM1512 with Comp1; 5A to 15A Load Step; and Min. Capacitance..... | 88 |
| Figure 5.207 | ZSPM1512 with Comp1; 15A to 5A Load Step; and Min. Capacitance..... | 88 |
| Figure 5.208 | ZSPM1512 with Comp1; 5A to 15A Load Step; and Max. Capacitance..... | 88 |
| Figure 5.209 | ZSPM1512 with Comp1; 15A to 5A Load Step; and Max. Capacitance..... | 88 |
| Figure 5.210 | Open Loop Bode Plots for ZSPM1512 with Comp1..... | 88 |
| Figure 5.211 | ZSPM1512 with Comp2; 5A to 15A Load Step; and Min. Capacitance..... | 89 |
| Figure 5.212 | ZSPM1512 with Comp2; 15A to 5A Load Step; and Min. Capacitance..... | 89 |
| Figure 5.213 | ZSPM1512 with Comp2; 5A to 15A Load Step; and Max. Capacitance..... | 89 |
| Figure 5.214 | ZSPM1512 with Comp2; 15A to 5A Load Step; and Max. Capacitance..... | 89 |
| Figure 5.215 | Open Loop Bode Plots for ZSPM1512 with Comp2..... | 89 |
| Figure 5.216 | ZSPM1512 with Comp3; 5A to 15A Load Step; and Min. Capacitance..... | 90 |
| Figure 5.217 | ZSPM1512 with Comp3; 15A to 5A Load Step; and Min. Capacitance..... | 90 |
| Figure 5.218 | ZSPM1512 with Comp3; 5A to 15A Load Step; and Max. Capacitance..... | 90 |
| Figure 5.219 | ZSPM1512 with Comp3; 15A to 5A Load Step; and Max. Capacitance..... | 90 |
| Figure 5.220 | Open Loop Bode Plots for ZSPM1512 with Comp3..... | 90 |
| Figure 5.221 | ZSPM1513 with Comp0; 5A to 15A Load Step; and Min. Capacitance..... | 91 |
| Figure 5.222 | ZSPM1513 with Comp0; 15A to 5A Load Step; and Min. Capacitance..... | 91 |
| Figure 5.223 | ZSPM1513 with Comp0; 5A to 15A Load Step; and Max. Capacitance..... | 91 |
| Figure 5.224 | ZSPM1513 with Comp0; 15A to 5A Load Step; and Max. Capacitance..... | 91 |
| Figure 5.225 | Open Loop Bode Plots for ZSPM1513 with Comp0..... | 91 |
| Figure 5.226 | ZSPM1513 with Comp1; 5A to 15A Load Step; and Min. Capacitance..... | 92 |
| Figure 5.227 | ZSPM1513 with Comp1; 15A to 5A Load Step; and Min. Capacitance..... | 92 |
| Figure 5.228 | ZSPM1513 with Comp1; 5 to 15A Load Step; and Max. Capacitance..... | 92 |
| Figure 5.229 | ZSPM1513 with Comp1; 15 to 5A Load Step; and Max. Capacitance..... | 92 |
| Figure 5.230 | Open Loop Bode Plots for ZSPM1513 with Comp1..... | 92 |
| Figure 5.231 | ZSPM1513 with Comp2; 5A to 15A Load Step; and Min. Capacitance..... | 93 |
| Figure 5.232 | ZSPM1513 with Comp2; 15A to 5A Load Step; and Min. Capacitance..... | 93 |
| Figure 5.233 | ZSPM1513 with Comp2; 5A to 15A Load Step; and Max. Capacitance..... | 93 |
| Figure 5.234 | ZSPM1513 with Comp2; 15A to 5A Load Step; and Max. Capacitance..... | 93 |
| Figure 5.235 | Open Loop Bode Plots for ZSPM1513 with Comp2..... | 93 |
| Figure 5.236 | ZSPM1513 with Comp3; 5A to 15A Load Step; and Min. Capacitance..... | 94 |
| Figure 5.237 | ZSPM1513 with Comp3; 15A to 5A Load Step; and Min. Capacitance..... | 94 |

| | | |
|--------------|---|----|
| Figure 5.238 | ZSPM1513 with Comp3; 5A to 15A Load Step; and Max. Capacitance..... | 94 |
| Figure 5.239 | ZSPM1513 with Comp3; 15A to 5A Load Step; and Max. Capacitance..... | 94 |
| Figure 5.240 | Open Loop Bode Plots for ZSPM1513 with Comp3..... | 94 |
| Figure 5.241 | Typical Efficiency Curves: ZSPM1502 with ZSPM9000, ZSPM9015, and ZSPM9060 DrMOS ($V_{IN} = 12V$; $V_{out} = 1.0V$)..... | 95 |
| Figure 5.242 | Typical Efficiency Curves: ZSPM9000 DrMOS with ZSPM1504, ZSPM1505, and ZSPM1506 ($V_{IN} = 12V$)..... | 96 |
| Figure 5.243 | Typical Efficiency Curves: ZSPM9000 and ZSPM9060 DrMOS with ZSPM1508 and ZSPM150997 | |
| Figure 5.244 | Typical Efficiency Curves: ZSPM9000 and ZSPM9060 DrMOS with ZSPM1511, ZSPM1512, and ZSPM1513 | 98 |
| Figure 6.1 | 24-Pin QFN Package Drawing | 99 |

List of Tables

| | | |
|------------|--|----|
| Table 2.1 | ZSPM15xx Pin Descriptions..... | 27 |
| Table 3.1 | Fault Configuration Overview..... | 32 |
| Table 4.1 | Passive Component Values for the Application Circuits..... | 35 |
| Table 4.2 | Passive Components for the ZSPM1501, ZSPM1502, and ZSPM1503..... | 36 |
| Table 4.3 | Passive Components for the ZSPM1504, ZSPM1505, and ZSPM1506..... | 36 |
| Table 4.4 | Passive Components for the ZSPM1507..... | 37 |
| Table 4.5 | Passive Components for the ZSPM1508 and ZSPM1509..... | 37 |
| Table 4.6 | Passive Components for the ZSPM1511, ZSPM1512, and ZSPM1513..... | 37 |
| Table 4.7 | ZSPM15xx – OCP Pin Strap Resistor Selection..... | 40 |
| Table 4.8 | Recommended Output Capacitor Ranges..... | 41 |
| Table 4.9 | Compensator and VOUT Slew Rate Pin Strap Resistor Selection for the ZSPM1501 to ZSPM1506 and the ZSPM1511 to ZSPM1513..... | 42 |
| Table 4.10 | Compensator and VOUT Slew Rate Pin Strap Resistor Selection for the ZSPM1507..... | 43 |
| Table 4.11 | Compensator and VOUT Slew Rate Pin Strap Resistor Selection for the ZSPM1508..... | 44 |
| Table 4.12 | Compensator and VOUT Slew Rate Pin Strap Resistor Selection for the ZSPM1509..... | 45 |

1 IC Characteristics

Note: The absolute maximum ratings are stress ratings only. The ZSPM15xx might not function or be operable above the recommended operating conditions. Stresses exceeding the absolute maximum ratings might also damage the device. In addition, extended exposure to stresses above the recommended operating conditions might affect device reliability. IDT does not recommend designing to the “Absolute Maximum Ratings.”

1.1. Absolute Maximum Ratings

| PARAMETER | PINS | CONDITIONS | MIN | TYPICAL | MAX | UNITS |
|--|---|--|------|---------|---------|-------|
| Supply voltages | | | | | | |
| 5V supply voltage | VDD50 | dV/dt < 0.15V/μs | -0.3 | | 5.5 | V |
| Maximum slew rate | | | | | 0.15 | V/μs |
| 3.3V supply voltage | VDD33 | | -0.3 | | 3.6 | V |
| 1.8V supply voltage | VDD18 AVDD18 | | -0.3 | | 2.0 | V |
| Digital pins | | | | | | |
| Digital I/O pins | THSHDN CONTROL PGOOD DRVEN PWM | | -0.3 | | 5.5 | V |
| Analog pins | | | | | | |
| Current sensing | ISNSP, ISNSN | | -0.3 | | 5.5 | V |
| Voltage feedback | VFBP VFBN | | -0.3 | | 2.0 | V |
| All other analog pins | ADCVREF VREFP TEMP VIN CONFIG0 CONFIG1 | | -0.3 | | 2.0 | V |
| Ambient Conditions | | | | | | |
| Junction temperature T _J | | | | | 125 | °C |
| Storage temperature | | | -40 | | 150 | °C |
| Electrostatic discharge – Human Body Model | | ESD testing is performed according to the respective JEDEC standard. | | | +/-2k | V |
| Electrostatic discharge – Charge Device Model | | ESD testing is performed according to the respective JEDEC standard. | | | +/- 500 | V |

1.2. Recommended Operating Conditions

| PARAMETER | SYMBOL | CONDITIONS | MIN | TYPICAL | MAX | UNITS |
|--|---------------|------------|-----|---------|-----|-------|
| Ambient conditions | | | | | | |
| Operation temperature | T_J | | -40 | | 125 | °C |
| Thermal resistance junction to ambient | θ_{JA} | | | 40 | | K/W |

1.3. Electrical Parameters

| PARAMETER | SYMBOL | CONDITIONS | MIN | TYPICAL | MAX | UNITS |
|--|-----------------------------|--|------|---------|-------|-------|
| Supply voltages | | | | | | |
| 5V supply voltage | V_{VDD50} | | 4.75 | 5.0 | 5.25 | V |
| 5V supply current | I_{VDD50} | VDD50=5.0V | | 23 | | mA |
| 3.3V supply voltage | V_{VDD33} | Supply for both the VDD33 and VDD50 pins if the internal 3.3V regulator is not used. | 3.0 | 3.3 | 3.6 | V |
| 3.3V supply current | I_{VDD33} | VDD50=VDD33=3.3V | | 23 | | mA |
| Internally generated supply voltages | | | | | | |
| 3.3V supply voltage | V_{VDD33} | VDD50=5.0V | 3.0 | 3.3 | 3.6 | V |
| 3.3V output current | I_{VDD33} | VDD50=5.0V | | | 2.0 | mA |
| 1.8V supply voltages | V_{AVDD18} V_{VDD18} | VDD50=5.0V | 1.72 | 1.80 | 1.98 | V |
| 1.8V output current | | | | | 0 | mA |
| Power-on reset (POR) | | | | | | |
| Power-on reset threshold – on | $V_{TH_POR_ON}$ | | | 2.8 | | V |
| Power-on reset threshold – off | $V_{TH_POR_OFF}$ | | | 2.6 | | V |
| Initialization period / internal startup time | | | | 5 | | ms |
| Digital IO pins (CONTROL, PGOOD, DRVEN, THSHDN) | | | | | | |
| Input high voltage | | VDD33=3.3V | 2.0 | | | V |
| Input low voltage | | VDD33=3.3V | | | 0.8 | V |
| Output high voltage | | VDD33=3.3V | 2.4 | | VDD33 | V |
| Output low voltage | | | | | 0.5 | V |
| Input leakage current | | | | | ±1.0 | μA |
| Output current – high | | | | | 2.0 | mA |
| Output current – low | | | | | 2.0 | mA |

| PARAMETER | SYMBOL | CONDITIONS | MIN | TYPICAL | MAX | UNITS |
|--|------------------------|--|------------------------|------------------------|-------|----------------------|
| Digital IO pins with tri-state capability (PWM) | | | | | | |
| Output high voltage | | VDD33=3.3V | 2.4 | | VDD33 | V |
| Output low voltage | | | | | 0.5 | V |
| Output current – high | | | | | 2.0 | mA |
| Output current – low | | | | | 2.0 | mA |
| Tri-state leakage current | | | | | ±1.0 | µA |
| Output voltage | | | | | | |
| Output voltage | | The output voltage set-point is determined by product code. | | (Refer to section 1.4) | | |
| Set-point accuracy | | VOUT=1.4V | | 1 | | % |
| Output voltage sequencing (see Figure 3.2) | | | | | | |
| Turn-on delay - | t _{ON_DELAY} | | | 1 | | ms |
| Turn-on rise time (slew rate) | t _{ON_RISE} | The rise time is configurable via pin strapping. | (Refer to section 4.8) | | | |
| Turn-on timeout | t _{ON_MAX} | | | 10 | | ms |
| Turn-off delay | t _{OFF_DELAY} | | | 0 | | ms |
| Turn-off fall time | t _{OFF_FALL} | | 6 | | 10 | ms |
| Turn-off timeout | t _{OFF_MAX} | | | 500 | | ms |
| Power good turn-on level | | The power good threshold is a percentage of the nominal output voltage (V _{OUT_NOM}), which is preconfigured for the ZSPM15xx part number (see section 1.4). | | 95% | | V _{OUT_NOM} |
| Power good turn-off level | | | | 90% | | V _{OUT_NOM} |
| Inductor current measurement | | | | | | |
| Common mode voltage across ISNSP and ISNSN pins | | | 0 | | 5.0 | V |
| Differential voltage range across ISNSP and ISNSN pins | | | | | ±100 | mV |
| Accuracy | | | | 5 | | % |
| Over-current protection threshold | | The over-current protection threshold is configurable via pin strapping | (Refer to section 4.7) | | | |

| PARAMETER | SYMBOL | CONDITIONS | MIN | TYPICAL | MAX | UNITS |
|---|-----------------|------------|-----|---------|-----|-------|
| Digital pulse width modulator | | | | | | |
| Switching frequency | f _{sw} | | | 500 | | kHz |
| Resolution | | | | 163 | | ps |
| Frequency accuracy | | | | 2.0 | | % |
| Duty cycle | | | 2.5 | | 100 | % |
| External temperature measurement (note: only PN-junction sense elements are supported) | | | | | | |
| Offset voltage at 25°C | | | | 583 | | mV |
| Temperature coefficient | | | | -2.2 | | mV/K |
| Bias currents for external temperature sensing | | | | 60 | | μA |
| Accuracy of measurement | | | | ±5.0 | | K |
| Over-temperature threshold | | | | 105 | | °C |
| Internal temperature measurement | | | | | | |
| Accuracy of measurement | | | | ±5.0 | | K |
| Over-temperature threshold | | | | 95 | | °C |

1.4. Device-Specific System Parameters

1.4.1. ZSPM1501

Note: In the following table, DNP (“do not place”) indicates the component is not used in the application circuit. Refer to Figure 2.1 for the components referenced below.

| PARAMETER | SYMBOL | CONDITIONS | MIN | TYPICAL | MAX | UNITS |
|--|----------------|-------------------------------------|------|---------|------|------------|
| System power parameters | | | | | | |
| Switching frequency | f_{SW} | | | 500 | | kHz |
| Input voltage | | | 10.8 | | 13.2 | V |
| Nominal output voltage | V_{OUT_NOM} | R5=1.0k Ω , R4=DNP | | 0.85 | | V |
| Output voltage under-voltage lockout threshold | | | | 0.764 | | V |
| Output voltage over-voltage lockout threshold | | | | 1.019 | | V |
| Input voltage over-voltage lockout threshold | | R9=9.1k Ω , R8=1.0k Ω | | 13.80 | | V |
| Input voltage under-voltage lockout threshold | | R9=9.1k Ω , R8=1.0k Ω | | 9.60 | | V |
| Application circuit | | | | | | |
| Optimal output inductance: L1 | L_{OUT} | | | 330 | | nH |
| Feedback divider: R5 | | | | 1.0 | | k Ω |
| Feedback divider: R4 | | | | DNP | | |

1.4.2. ZSPM1502

Note: In the following table, DNP (“do not place”) indicates the component is not used in the application circuit. Refer to Figure 2.1 for the components referenced below.

| PARAMETER | SYMBOL | CONDITIONS | MIN | TYPICAL | MAX | UNITS |
|--|----------------|-------------------------------------|------|---------|------|-------|
| System power parameters | | | | | | |
| Switching frequency | f_{SW} | | | 500 | | kHz |
| Input voltage | | | 10.8 | | 13.2 | V |
| Nominal output voltage | V_{OUT_NOM} | R5=1.0k Ω , R4=DNP | | 1.0 | | V |
| Output voltage under-voltage lockout threshold | | | | 0.90 | | V |
| Output voltage over-voltage lockout threshold | | | | 1.20 | | V |
| Input voltage over-voltage lockout threshold | | R9=9.1k Ω , R8=1.0k Ω | | 13.80 | | V |
| Input voltage under-voltage lockout threshold | | R9=9.1k Ω , R8=1.0k Ω | | 9.60 | | V |

| PARAMETER | SYMBOL | CONDITIONS | MIN | TYPICAL | MAX | UNITS |
|--------------------------------|------------------|------------|-----|---------|-----|-------|
| Application circuit | | | | | | |
| Optimal output inductance – L1 | L _{OUT} | | | 330 | | nH |
| Feedback divider – R5 | | | | 1.0 | | kΩ |
| Feedback divider – R4 | | | | DNP | | |

1.4.3. ZSPM1503

Note: In the following table, DNP (“do not place”) indicates the component is not used in the application circuit. Refer to Figure 2.1 for the components referenced below.

| PARAMETER | SYMBOL | CONDITIONS | MIN | TYPICAL | MAX | UNITS |
|--|----------------------|--------------------|------|---------|------|-------|
| System power parameters | | | | | | |
| Switching frequency | f _{SW} | | | 500 | | kHz |
| Input voltage | | | 10.8 | | 13.2 | V |
| Nominal output voltage | V _{OUT_NOM} | R5=1.0kΩ, R4=DNP | | 1.20 | | V |
| Output voltage under-voltage lockout threshold | | | | 1.08 | | V |
| Output voltage over-voltage lockout threshold | | | | 1.44 | | V |
| Input voltage over-voltage lockout threshold | | R9=9.1kΩ, R8=1.0kΩ | | 13.80 | | V |
| Input voltage under-voltage lockout threshold | | R9=9.1kΩ, R8=1.0kΩ | | 9.60 | | V |
| Application circuit | | | | | | |
| Optimal output inductance – L1 | L _{OUT} | | | 330 | | nH |
| Feedback divider – R5 | | | | 1.0 | | kΩ |
| Feedback divider – R4 | | | | DNP | | |

1.4.4. ZSPM1504

Note: Refer to Figure 2.1 for the components referenced below.

| PARAMETER | SYMBOL | CONDITIONS | MIN | TYPICAL | MAX | UNITS |
|--|----------------|--------------------|------|---------|------|-------|
| System power parameters | | | | | | |
| Switching frequency | f_{sw} | | | 500 | | kHz |
| Input voltage | | | 10.8 | | 13.2 | V |
| Nominal output voltage | V_{OUT_NOM} | R5=750Ω, R4=1.0kΩ | | 1.5 | | V |
| Output voltage under-voltage lockout threshold | | | | 1.35 | | V |
| Output voltage over-voltage lockout threshold | | | | 1.80 | | V |
| Input voltage over-voltage lockout threshold | | R9=9.1kΩ, R8=1.0kΩ | | 13.80 | | V |
| Input voltage under-voltage lockout threshold | | R9=9.1kΩ, R8=1.0kΩ | | 9.60 | | V |
| Application circuit | | | | | | |
| Optimal output inductance – L1 | L_{OUT} | | | 470 | | nH |
| Feedback divider – R5 | | | | 750 | | Ω |
| Feedback divider – R4 | | | | 1.0 | | kΩ |

1.4.5. ZSPM1505

Note: Refer to Figure 2.1 for the components referenced below.

| PARAMETER | SYMBOL | CONDITIONS | MIN | TYPICAL | MAX | UNITS |
|--|----------------|--------------------|------|---------|------|-------|
| System power parameters | | | | | | |
| Switching frequency | f_{sw} | | | 500 | | kHz |
| Input voltage | | | 10.8 | | 13.2 | V |
| Nominal output voltage | V_{OUT_NOM} | R5=750Ω, R4=1.0kΩ | | 1.8 | | V |
| Output voltage under-voltage lockout threshold | | | | 1.62 | | V |
| Output voltage over-voltage lockout threshold | | | | 2.16 | | V |
| Input voltage over-voltage lockout threshold | | R9=9.1kΩ, R8=1.0kΩ | | 13.80 | | V |
| Input voltage under-voltage lockout threshold | | R9=9.1kΩ, R8=1.0kΩ | | 9.60 | | V |

| PARAMETER | SYMBOL | CONDITIONS | MIN | TYPICAL | MAX | UNITS |
|--------------------------------|------------------|------------|-----|---------|-----|-------|
| Application circuit | | | | | | |
| Optimal output inductance – L1 | L _{OUT} | | | 470 | | nH |
| Feedback divider – R5 | | | | 750 | | Ω |
| Feedback divider – R4 | | | | 1.0 | | kΩ |

1.4.6. ZSPM1506

Note: Refer to Figure 2.1 for the components referenced below.

| PARAMETER | SYMBOL | CONDITIONS | MIN | TYPICAL | MAX | UNITS |
|--|----------------------|--------------------|------|---------|------|-------|
| System power parameters | | | | | | |
| Switching frequency | f _{SW} | | | 500 | | kHz |
| Input voltage | | | 10.8 | | 13.2 | V |
| Nominal output voltage | V _{OUT_NOM} | R5=750Ω, R4=1.0kΩ | | 2.0 | | V |
| Output voltage under-voltage lockout threshold | | | | 1.80 | | V |
| Output voltage over-voltage lockout threshold | | | | 2.40 | | V |
| Input voltage over-voltage lockout threshold | | R9=9.1kΩ, R8=1.0kΩ | | 13.80 | | V |
| Input voltage under-voltage lockout threshold | | R9=9.1kΩ, R8=1.0kΩ | | 9.60 | | V |
| Application circuit | | | | | | |
| Optimal output inductance – L1 | L _{OUT} | | | 470 | | nH |
| Feedback divider – R5 | | | | 750 | | Ω |
| Feedback divider – R4 | | | | 1.0 | | kΩ |

1.4.7. ZSPM1507

| PARAMETER | SYMBOL | CONDITIONS | MIN | TYPICAL | MAX | UNITS |
|--|----------------|-------------------------------------|------|---------|------|------------|
| System power parameters | | | | | | |
| Switching frequency | f_{SW} | | | 500 | | kHz |
| Input voltage | | | 10.8 | 12 | 13.2 | V |
| Nominal output voltage | V_{OUT_NOM} | R5=1.0k Ω , R4=1.0k Ω | | 2.5V | | V |
| Output voltage under-voltage lockout threshold | | | | 2.25 | | V |
| Output voltage over-voltage lockout threshold | | | | 3.0 | | V |
| Input voltage over-voltage lockout threshold | | R9=9.1k Ω , R8=1.0k Ω | | 13.8 | | V |
| Input voltage under-voltage lockout threshold | | R9=9.1k Ω , R8=1.0k Ω | | 9.6 | | V |
| Application circuit | | | | | | |
| Optimal output inductance: L1 | L_{OUT} | | | 1000 | | nH |
| Feedback divider: R5 | | | | 1.0 | | k Ω |
| Feedback divider: R4 | | | | 1.0 | | k Ω |

1.4.8. ZSPM1508

| PARAMETER | SYMBOL | CONDITIONS | MIN | TYPICAL | MAX | UNITS |
|--|----------------|-------------------------------------|------|---------|------|------------|
| System power parameters | | | | | | |
| Switching frequency | f_{SW} | | | 500 | | kHz |
| Input voltage | | | 10.8 | | 13.2 | V |
| Nominal output voltage | V_{OUT_NOM} | R5=3.3k Ω , R4=1.0k Ω | | 3.3 | | V |
| Output voltage under-voltage lockout threshold | | | | 2.97 | | V |
| Output voltage over-voltage lockout threshold | | | | 3.96 | | V |
| Input voltage over-voltage lockout threshold | | R9=9.1k Ω , R8=1.0k Ω | | 13.80 | | V |
| Input voltage under-voltage lockout threshold | | R9=9.1k Ω , R8=1.0k Ω | | 9.60 | | V |
| Application circuit | | | | | | |
| Optimal output inductance: L1 | L_{OUT} | | | 2.20 | | μ H |
| Feedback divider: R5 | | | | 3.3 | | k Ω |
| Feedback divider: R4 | | | | 1.0 | | k Ω |

1.4.9. ZSPM1509

| PARAMETER | SYMBOL | CONDITIONS | MIN | TYPICAL | MAX | UNITS |
|--|----------------|-------------------------------------|------|---------|------|------------|
| System power parameters | | | | | | |
| Switching frequency | f_{SW} | | | 500 | | kHz |
| Input voltage | | | 10.8 | | 13.2 | V |
| Nominal output voltage | V_{OUT_NOM} | R5=3.3k Ω , R4=1.0k Ω | | 5.0 | | V |
| Output voltage under-voltage lockout threshold | | | | 4.50 | | V |
| Output voltage over-voltage lockout threshold | | | | 5.50 | | V |
| Input voltage over-voltage lockout threshold | | R9=9.1k Ω , R8=1.0k Ω | | 13.80 | | V |
| Input voltage under-voltage lockout threshold | | R9=9.1k Ω , R8=1.0k Ω | | 9.60 | | V |
| Application circuit | | | | | | |
| Optimal output inductance: L1 | L_{OUT} | | | 2.20 | | μ H |
| Feedback divider: R5 | | | | 3.3 | | k Ω |
| Feedback divider: R4 | | | | 1.0 | | k Ω |

1.4.10. ZSPM1511

Note: In the following table, DNP (“do not place”) indicates the component is not used in the application circuit.

| PARAMETER | SYMBOL | CONDITIONS | MIN | TYPICAL | MAX | UNITS |
|--|----------------|--------------------------------------|------|---------|------|------------|
| System power parameters | | | | | | |
| Switching frequency | f_{SW} | | | 500 | | kHz |
| Input voltage | | | 10.8 | | 13.2 | V |
| Nominal output voltage | V_{OUT_NOM} | R5=1.0k Ω , R4=DNP | | 0.85 | | V |
| Output voltage under-voltage lockout threshold | | | | 0.764 | | V |
| Output voltage over-voltage lockout threshold | | | | 1.019 | | V |
| Input voltage over-voltage lockout threshold | | R9=9.1 k Ω , R8=1.0k Ω | | 13.80 | | V |
| Input voltage under-voltage lockout threshold | | R9=9.1 k Ω , R8=1.0k Ω | | 9.60 | | V |
| Application circuit | | | | | | |
| Optimal output inductance – L1 | L_{OUT} | | | 680 | | η H |
| Feedback divider – R5 | | | | 1.0 | | k Ω |
| Feedback divider – R4 | | | | DNP | | |

1.4.11. ZSPM1512

Note: In the following table, DNP (“do not place”) indicates the component is not used in the application circuit.

| PARAMETER | SYMBOL | CONDITIONS | MIN | TYPICAL | MAX | UNITS |
|--|----------------|--------------------------------------|------|---------|------|------------|
| System power parameters | | | | | | |
| Switching frequency | f_{sw} | | | 500 | | kHz |
| Input voltage | | | 10.8 | | 13.2 | V |
| Nominal output voltage | V_{OUT_NOM} | R5=1.0k Ω , R4=DNP | | 1.0 | | V |
| Output voltage under-voltage lockout threshold | | | | 0.90 | | V |
| Output voltage over-voltage lockout threshold | | | | 1.20 | | V |
| Input voltage over-voltage lockout threshold | | R9=9.1 k Ω , R8=1.0k Ω | | 13.80 | | V |
| Input voltage under-voltage lockout threshold | | R9=9.1 k Ω , R8=1.0k Ω | | 9.60 | | V |
| Application circuit | | | | | | |
| Optimal output inductance – L1 | L_{OUT} | | | 680 | | η H |
| Feedback divider – R5 | | | | 1.0 | | k Ω |
| Feedback divider – R4 | | | | DNP | | k Ω |

1.4.12. ZSPM1513

Note: In the following table, DNP (“do not place”) indicates the component is not used in the application circuit.

| PARAMETER | SYMBOL | CONDITIONS | MIN | TYPICAL | MAX | UNITS |
|--|----------------|--------------------------------------|------|---------|------|------------|
| System power parameters | | | | | | |
| Switching frequency | f_{sw} | | | 500 | | kHz |
| Input voltage | | | 10.8 | | 13.2 | V |
| Nominal output voltage | V_{OUT_NOM} | R5=1.0k Ω , R4=DNP | | 1.20 | | V |
| Output voltage under-voltage lockout threshold | | | | 1.08 | | V |
| Output voltage over-voltage lockout threshold | | | | 1.44 | | V |
| Input voltage over-voltage lockout threshold | | R9=9.1 k Ω , R8=1.0k Ω | | 13.80 | | V |
| Input voltage under-voltage lockout threshold | | R9=9.1 k Ω , R8=1.0k Ω | | 9.60 | | V |
| Application circuit | | | | | | |
| Optimal output inductance – L1 | L_{OUT} | | | 680 | | η H |
| Feedback divider – R5 | | | | 1.0 | | k Ω |
| Feedback divider – R4 | | | | DNP | | k Ω |

2 Product Summary

2.1. Overview

The ZSPM15xx is a configurable true-digital single-phase PWM controller for high-current, non-isolated DC/DC supplies. It incorporates a pre-configured digital control loop, which is optimized for different power stages, bundled with output voltage sensing, average inductor current sensing, and extensive fault monitoring and handling options.

Several different functional units are incorporated in the device. A dedicated digital control loop is used to provide fast loop response and optimal output voltage regulation. This includes output voltage sensing, average inductor current sensing, a digital control law, and a digital pulse-width modulator (DPWM). In parallel, a dedicated, configurable error handler allows fast detection of error signals and their appropriate handling. A housekeeping analog-to-digital converter (HKADC) ensures the reliable and efficient measurement of environmental signals, such as input voltage and temperature.

An application-specific, low-power integrated microcontroller is used to control the overall system. It manages configuration of the various logic units according to the preprogrammed configuration look-up tables and the external configuration resistors connected to the CONFIG0 and CONFIG1 pins. These pin-strapping resistors expedite configuration of the over-current protection threshold, compensation, and output voltage slew rate. A high-reliability, high-temperature one-time programmable memory (OTP) is used to store configuration parameters. All required bias and reference voltages are internally derived from the external supply voltage.

Figure 2.1 Typical Application Circuit with a 5V Supply Voltage

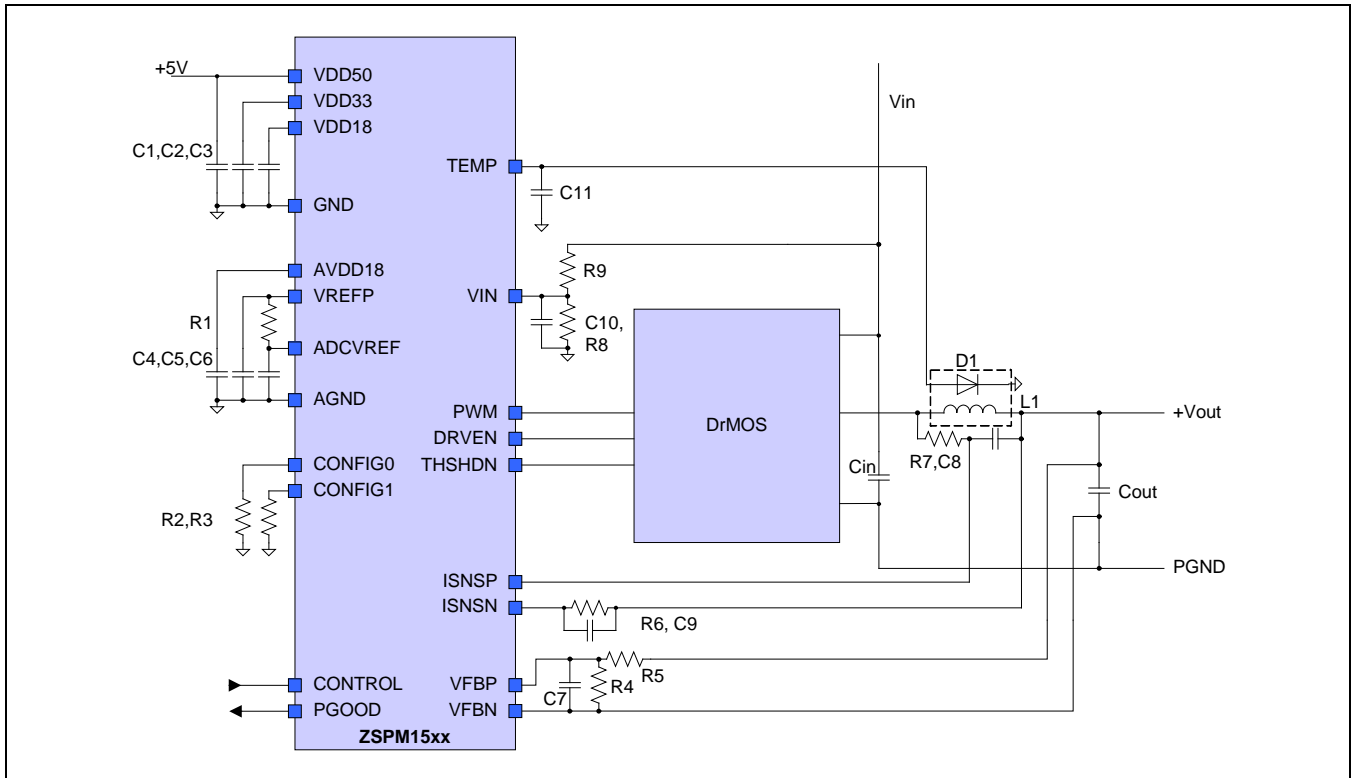
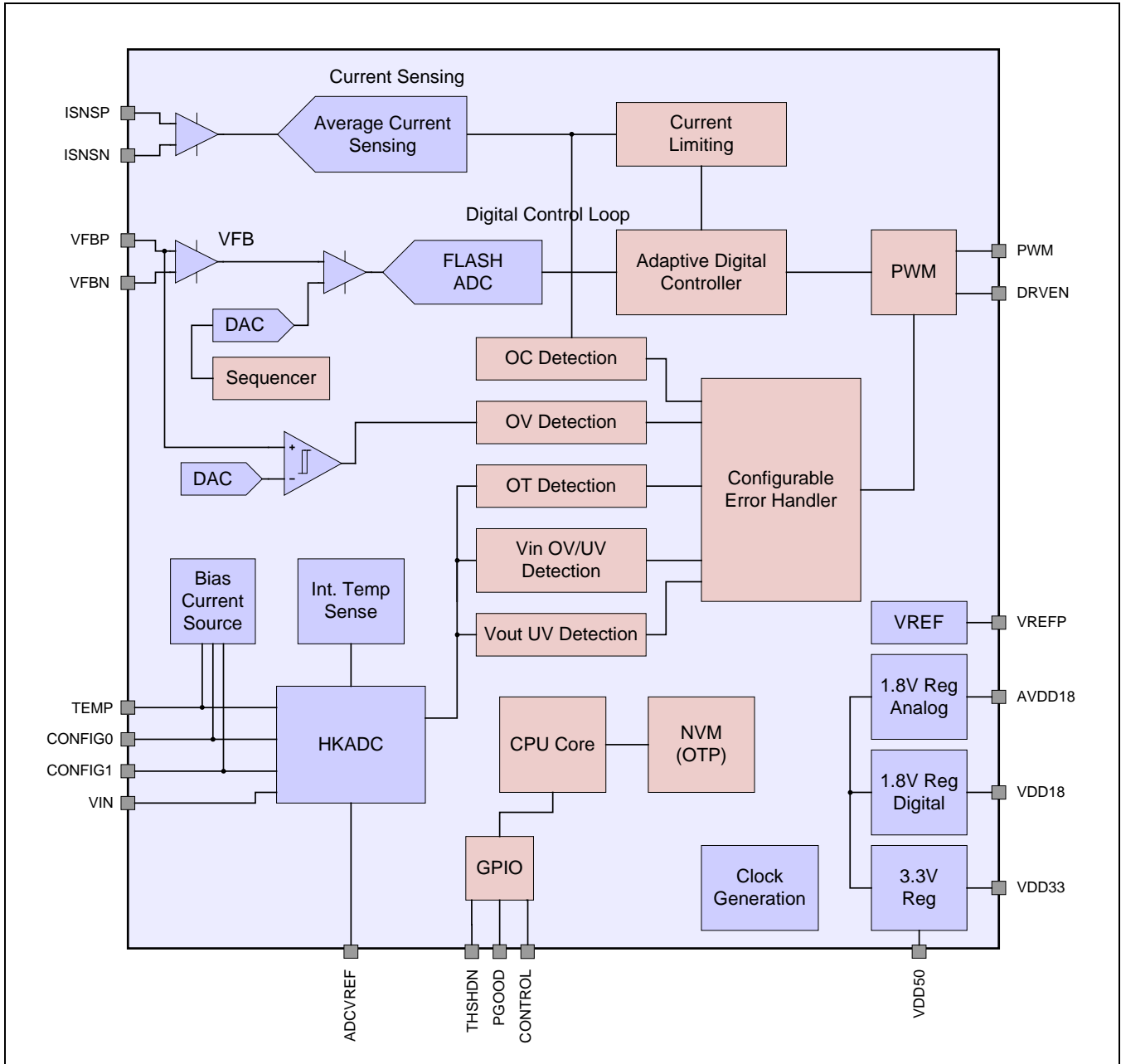

Figure 2.2 Block Diagram



2.2. Pin Description

Table 2.1 ZSPM15xx Pin Descriptions

| Pin | Name | Direction | Type | Description |
|-----|---------|--------------|---------|---|
| 1 | AGND | Input | Supply | Analog Ground |
| 2 | VREFP | Output | Supply | Reference Terminal |
| 3 | VFBP | Input | Analog | Positive Input of Differential Feedback Voltage Sensing |
| 4 | VFBN | Input | Analog | Negative Input of Differential Feedback Voltage Sensing |
| 5 | ISNSP | Input | Analog | Positive Input of Differential Current Sensing |
| 6 | ISNSN | Input | Analog | Negative Input of Differential Current Sensing |
| 7 | TEMP | Input | Analog | Connection to External Temperature Sensing Element |
| 8 | VIN | Input | Analog | Power Supply Input Voltage Sensing |
| 9 | CONFIG0 | Input | Analog | Configuration Selection 0 |
| 10 | CONFIG1 | Input | Analog | Configuration Selection 1 |
| 11 | PWM | Output | Digital | High-side FET Control Signal |
| 12 | DRVEN | Output | Digital | Driver Enable Signal |
| 13 | PGOOD | Output | Digital | PGOOD Output (Internal Pull-Down) |
| 14 | CONTROL | Input | Digital | Control Input |
| 15 | THSHDN | Input | Digital | Thermal-Shut Down Input from Power Stage |
| 16 | N.C. | | | No connection – pin must be allowed to float |
| 17 | N.C. | | | No connection – pin must be allowed to float |
| 18 | N.C. | | | No connection – pin must be allowed to float |
| 19 | GND | Input | Supply | Digital Ground |
| 20 | VDD18 | Output | Supply | Internal 1.8V Digital Supply Terminal |
| 21 | VDD33 | Input/Output | Supply | 3.3V Supply Voltage Terminal |
| 22 | VDD50 | Input | Supply | 5.0V Supply Voltage Terminal |
| 23 | AVDD18 | Output | Supply | Internal 1.8V Analog Supply Terminal |
| 24 | ADCVREF | Input | Analog | Analog-to-Digital Converter (ADC) Reference Terminal |
| PAD | PAD | Input | Supply | Exposed PAD, Digital Ground |

2.3. Available Packages

The ZSPM15xx is available in a 24-pin QFN package. The pin-out is shown in Figure 2.3. The mechanical drawing of the package can be found in Figure 6.1.

Figure 2.3 Pin-out QFN24 Package

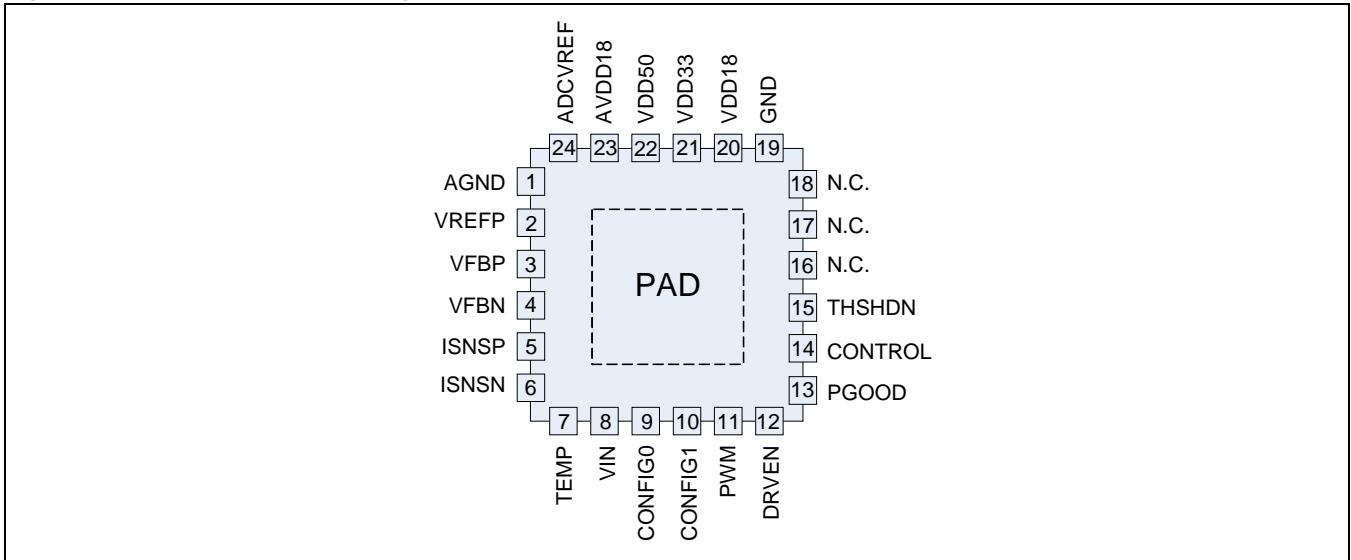

3 Functional Description

3.1. Power Supply Circuitry, Reference Decoupling, and Grounding

The ZSPM15xx incorporates several internal power regulators in order to derive all required supply and bias voltages from a single external supply voltage of 5.0V. Decoupling capacitors are required at the VDD33, VDD18, and AVDD18 pins (1.0 μ F minimum; 4.7 μ F recommended).

The reference voltages required for operation are generated within the ZSPM15xx. External decoupling must be provided between the VREFP and ADCVREF pins. Therefore, a 4.7 μ F capacitor is required at the VREFP pin and a 100nF capacitor at ADCVREF pin. The two pins should be connected with approximately 50 Ω resistance in order to provide sufficient decoupling between the pins.

Three different ground connections are available on the outside of the package. These should be connected together to a single ground tie. A differentiation between analog and digital ground is not required.

3.2. Reset/Start-up Behavior

The ZSPM15xx employs an internal power-on-reset (POR) circuit to ensure proper start-up and shut-down with a changing supply voltage. Once the supply voltage increases above the POR threshold voltage (see section 1.3), the ZSPM15xx begins the internal start-up process. Upon its completion, the device is ready for operation.

3.3. Digital Power Control

3.3.1. Overview

The digital power control loop consists of the integral parts required for the control functionality of the ZSPM15xx. A high-speed analog front-end is used to digitize the output voltage. A digital control core uses the acquired information to provide duty-cycle information to the PWM, which controls the drive signals to the power stage.

See section 7 for the pre-configured nominal output voltages for the different part codes available in the ZSPM15xx family.

3.3.2. Output Voltage Feedback

The voltage feedback signal is sampled with a high-speed analog front-end. The feedback voltage is differentially measured and subtracted from an internal voltage reference using an error amplifier. A flash ADC is then used to convert the voltage into its digital equivalent. This is followed by internal digital filtering to improve the system's noise rejection.

For some applications, an external feedback divider (R4 and R5; see Figure 4.1) is required to allow for output voltage operations above the internal reference voltage. For details, refer to the application section 4.3.

3.3.3. Digital Compensator

The sampled output voltage is processed by a digital control loop in order to modulate the DPWM output signals controlling the power stage. This digital control loop works as a voltage-mode controller using a PID-type compensation. The basic structure of the controller is shown in Figure 3.1. The proprietary State-Law™ Control (SLC) concept features two parallel compensators for steady-state operation and fast transient operation. This allows tuning the compensators individually for the respective needs; i.e., quiet steady state and fast transient performance. The ZSPM15xx implements fast, reliable switching between the different compensation modes in order to ensure good transient performance and a quiet steady state.

Figure 3.1 Simplified Block Diagram of the Digital Compensation

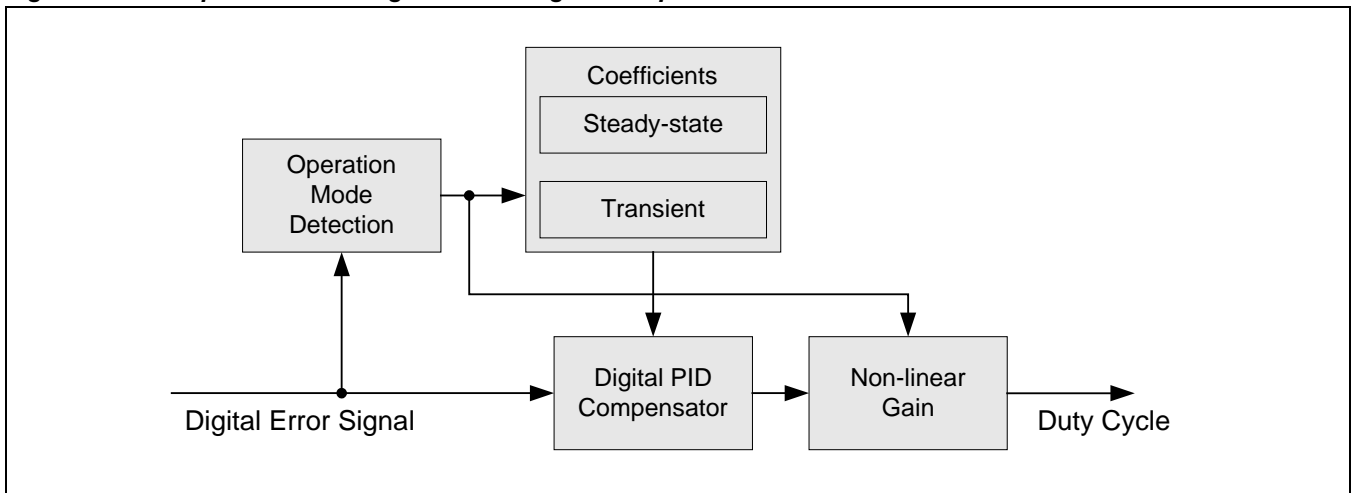

Two techniques are used to improve transient performance further:

- Tru-sample Technology™ is used to acquire fast, accurate, and continuous information about the output voltage so that the device can react quickly to any change in output voltage. Tru-sample Technology™ reduces phase-lag caused by sampling delays, reduces noise sensitivity, and improves transient performance.
- A nonlinear gain adjustment is used during large load transients to boost the loop gain and reduce the settling time.

The control loops in the ZSPM15xx are preconfigured and can be selected using a pin-strapping option. A range of different output capacitors is supported. Refer to section 4.8 for detailed information.

3.3.4. Power Sequencing and the CONTROL Pin

The ZSPM15xx has a set of pre-configured power-sequencing features. The typical sequence of events is shown in Figure 3.2. The individual values for the delay (t_{ON_DELAY} and t_{OFF_DELAY}), ramp time (t_{ON_RISE} and t_{OFF_FALL}) and time-outs (t_{ON_MAX} and t_{OFF_MAX}) are listed in section 1.3. Note that the device is slow-rate controlled for t_{ON_RISE} ramping via the pin-strapping options. The slew rate can be selected in the application circuit using the pin-strap options as explained in section 4.8.

The CONTROL pin is pre-configured for active high operation.

The ZSPM15xx features a power good (PGOOD) output, which can be used to indicate the state of the power rail. If the output voltage level is above the power good ON threshold, the pin is set to active, indicating a stable output voltage on the rail.

Figure 3.2 Power Sequencing

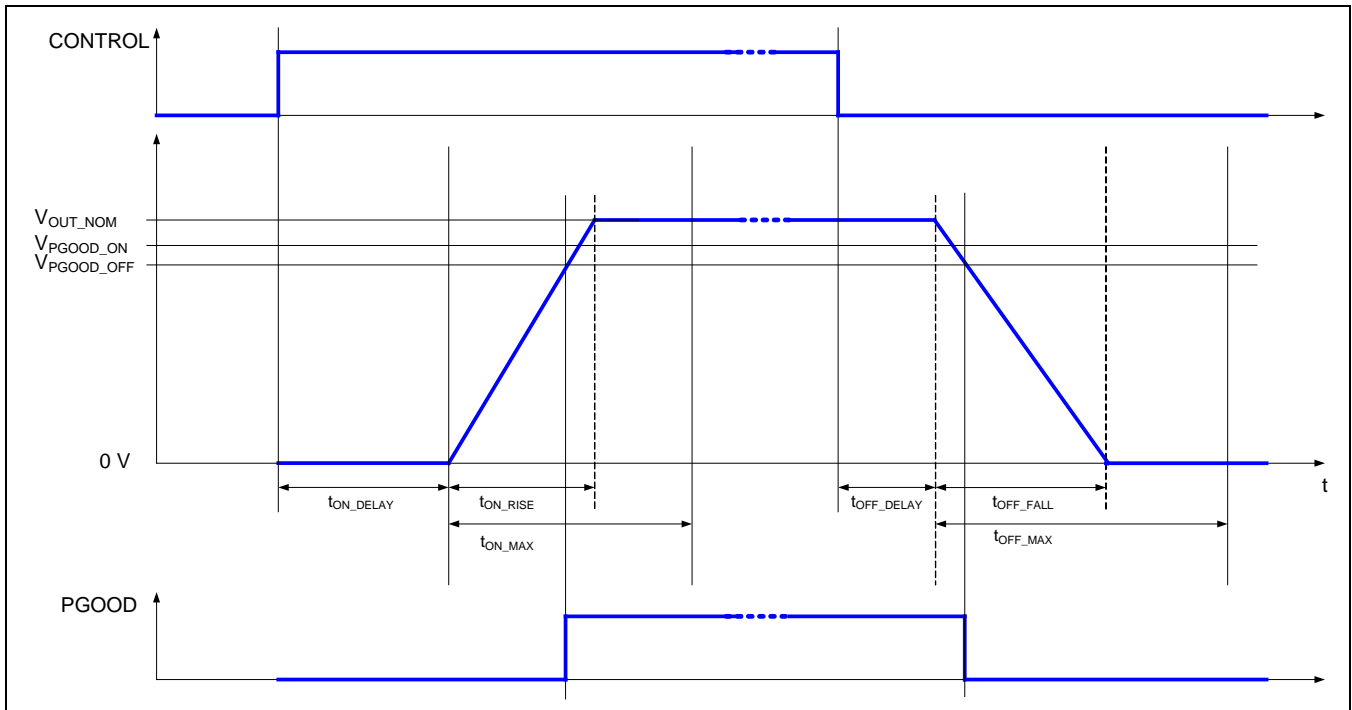

3.4. Fault Monitoring and Response Generation

The ZSPM15xx monitors various signals during operation and compares them with fault thresholds (see the “Threshold” column in Table 3.1). If a parameter exceeds a fault threshold, the respective fault signal is asserted and the ZSPM15xx will disable the output voltage as described below. Note that the ZSPM15xx features internal blanking times for voltage and temperature faults in order to improve noise-immunity.

Three different response types are supported by the ZSPM15xx. The “low-impedance” response turns off the top MOSFET and enables the low-side MOSFET; i.e., PWM=0. After t_{OFF_MAX} , both MOSFETs will be turned off, PWM=Z, DRVEN=0. A “high-impedance” response will disable both MOSFETs instantaneously, PWM=Z. A “soft-off” response ramps the output voltage down, similar to a power-down operation via the CONTROL pin. After t_{OFF_MAX} , the controller will disable the power stage by turning both switches off, PWM=Z, DRVEN=0. The ZSPM15xx features a “hiccup mode,” which allows it to re-enable its output voltage after the fault condition has been removed.

Table 3.1 Fault Configuration Overview

| Fault | Response Type | Blanking | Threshold |
|---------------------------|----------------|-------------|--|
| Output Over-Voltage | Low-impedance | 25 μ s | Preconfigured; see section 1.4. |
| Output Under-Voltage | High-impedance | 450 μ s | Preconfigured; see section 1.4. |
| Input Over-Voltage | High-impedance | 450 μ s | Preconfigured; see section 1.4. |
| Input Under-Voltage | High-impedance | 450 μ s | Preconfigured; see section 1.4. |
| Over-Current | Low-impedance | None | Pin-strap selectable; see section 4.7. |
| Internal Over-Temperature | Soft-off | 5ms | See specification in section 1.3. |
| External Over-Temperature | Soft-off | 5ms | See specification in section 1.3. |

3.4.1. Output Over/Under-Voltage

To prevent damage to the load, the ZSPM15xx utilizes an output over-voltage protection circuit. The voltage at VFBP is continuously compared with a preconfigured threshold using a high-speed analog comparator. If the voltage exceeds the configured threshold, the fault response is generated.

The ZSPM15xx also monitors the output voltage with a lower threshold. If the output voltage falls below the under-voltage fault level, a fault event is generated.

See section 1.4 for the device-specific threshold levels.

3.4.2. Output Current Protection

The ZSPM15xx offers cycle-by-cycle average current sensing with configurable over-current protection. A dedicated ADC is used to provide fast and accurate current information over the switching period. The acquired information is compared with a selectable over-current threshold to detect faults. DCR current sensing across the inductor is supported. Additionally, the device uses DCR temperature compensation via the external temperature sense element. This increases the accuracy of the current sense method by counteracting the significant change of the DCR over temperature.

The ZSPM15xx continuously monitors the average inductor current and utilizes this information to protect the power supply against excessive output current. If the average inductor current exceeds the selected over-current fault threshold, the fault response will be generated. See section 4.7 for instructions for configuring the threshold.

3.4.3. Input Voltage Protection

The ZSPM15xx continuously monitors the input voltage via the VIN pin. If the input voltage is outside an operation range defined by a lower and higher input voltage threshold, a fault is detected and a response generated. See section 1.4 for device-specific specifications for the thresholds.

3.4.4. Over-Temperature Protection

The ZSPM15xx features two independent temperature measurement units for internal and external temperature measurement. The internal temperature sensing measures the temperatures inside the ZSPM15xx. Place the external temperature sense element close to the inductor to measure its temperature. Use a PN-junction as the external temperature sense element. Small-signal transistors, such the 3904, are widely used for this application.

The ZSPM15xx monitors these internal and external temperature measurements. If either of the temperatures exceeds the over-temperature threshold (see section 1.3), the fault response will be generated. For additional information on the external temperature sensing, refer to section 4.6.

4 Application Information

4.1. Application Schematic

Figure 4.1 ZSPM15xx – Application Circuit with a 5V Supply Voltage

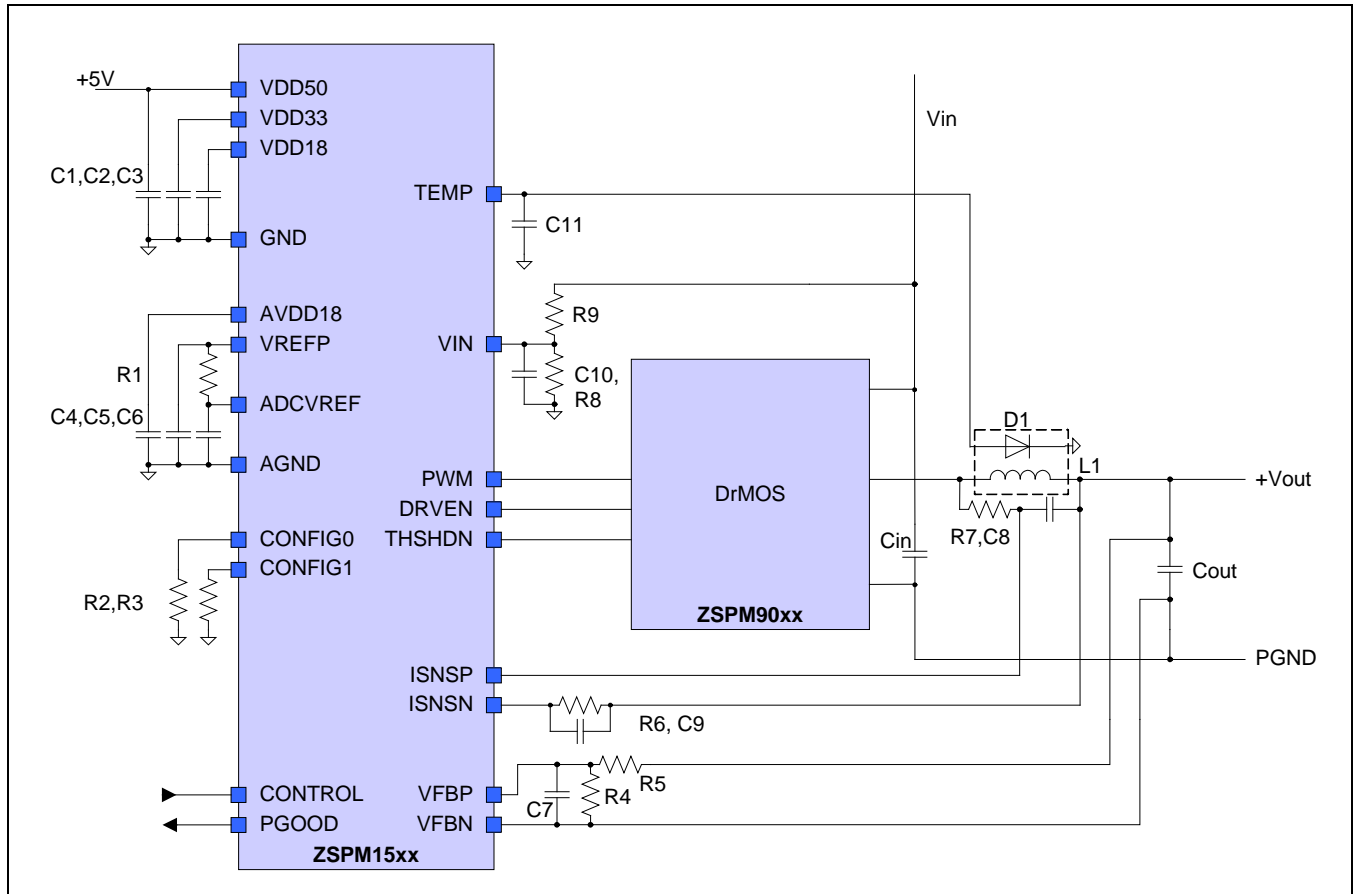

Table 4.1 *Passive Component Values for the Application Circuits*

| Reference Designator | Component Value | Description |
|--|-----------------|---|
| C1 | 1.0 μ F | Ceramic capacitor. |
| C2 | 4.7 μ F | Ceramic capacitor. Recommended: 4.7 μ F; minimum: 1.0 μ F. |
| C3 | 4.7 μ F | Ceramic capacitor. Recommended: 4.7 μ F; minimum: 1.0 μ F. |
| C4 | 4.7 μ F | Ceramic capacitor. Recommended: 4.7 μ F; minimum: 1.0 μ F. |
| C5 | 4.7 μ F* | Ceramic capacitor. |
| C6 | 100nF* | Ceramic capacitor. |
| C7 | 22pF | Output voltage sense filtering capacitor. Recommended: 22pF; maximum: 1nF. |
| C8, C9 | ** | DCR current-sense filter capacitor. |
| C10 | 100nF | Filter capacitor for input voltage – optional. |
| C11 | 100nF | Filter capacitor for external temperature – optional. |
| L1 | ** | Inductor. |
| Cin | | Input filter capacitors. Can be a combination of ceramic and electrolytic capacitors. |
| Cout | | Output filter capacitors. See section 4.8 for more information on the output capacitor selection. |
| R1 | 51 Ω * | Resistor. |
| R2, R3 | | Pin-strap configuration resistors. See sections 4.7 and 4.8. |
| R4 | ** | Output voltage feedback divider bottom resistor. Connect between the VFBN and VFBN pins. Important: Refer to section 1.4 to determine if R4 should be placed or not depending on the specific ZSPM15xx product code. |
| R5 | ** | Output voltage feedback divider top resistor. Connect between the output terminal and the VFBN pin. |
| R6, R7 | ** | DCR current-sense filter resistors. |
| R8 | 1.0k Ω * | Input voltage divider bottom resistor. Connect between the VIN and AGND pins of the ZSPM15xx. |
| R9 | 9.1k Ω * | Input voltage divider top resistor. Connect between the main power input and the VIN pin of the ZSPM15xx. |
| D1 | 3904 | External temperature sense element (PN-junction). See section 4.6. |
| <p>* Fixed component values marked with an asterisk (*) must not be changed.</p> <p>** Refer to section 4.2 for components marked with a double asterisk (**).</p> | | |

4.2. Device-Specific Passive Components

Each product in the ZSPM15xx family requires external device-specific passive components. These are listed in the following tables.

If specified in the following tables, the feedback divider (R4, R5) is mandatory to achieve the specified output voltage. The control loop has been optimized for the inductance specified, but inductors from different vendors can be used.

Note: The ZSPM15xx has been optimized for the specific Würth inductors recommended in the following tables depending on the ZSPM15xx product number. If a different inductor is used, its specifications should be comparable to the recommended Würth inductor; otherwise the full optimization provided by the ZSPM15xx might not be achieved. If a different inductor is used, the current sense components (R6, R7, C8) must be recalculated according to section 4.4.

Components specified as DNP must not be placed.

Table 4.2 *Passive Components for the ZSPM1501, ZSPM1502, and ZSPM1503*

| Reference Designator | Component Value | Description |
|-------------------------------------|-----------------|---|
| Feedback divider | | |
| R4 | DNP | Output voltage feedback divider bottom resistor. Important: Do not place R4 for the ZSPM1501, ZSPM1502, and ZSPM1503. |
| R5 | 1.0k Ω | Output voltage feedback divider top resistor. Connect between the output terminal and the VFBP pin. |
| Inductor and current sensing | | |
| L1 | L=330nH | Recommended inductor: Würth WE-HCM 744301033. |
| R6, R7 | 1050 Ω | DCR current-sense filter resistors. |
| C8, C9 | 1000nF | DCR current-sense filter capacitor. |

Table 4.3 *Passive Components for the ZSPM1504, ZSPM1505, and ZSPM1506*

| Reference Designator | Component Value | Description |
|-------------------------------------|-----------------|--|
| Feedback divider | | |
| R4 | 1k Ω | Output voltage feedback divider bottom resistor. |
| R5 | 750 Ω | Output voltage feedback divider top resistor. Connect between the output terminal and the VFBP pin. |
| Inductor and current sensing | | |
| L1 | L=470nH | Recommended inductor: Würth WE-HCM 744301047. |
| R6, R7 | 1000 Ω | DCR current-sense filter resistors. |
| C8, C9 | 1000nF | DCR current-sense filter capacitor. |

Table 4.4 *Passive Components for the ZSPM1507*

| Reference Designator | Component Value | Description |
|-------------------------------------|-----------------|--|
| Feedback divider | | |
| R4 | 1k Ω | Output voltage feedback divider bottom resistor. |
| R5 | 1k Ω | Output voltage feedback divider top resistor. Connect between the output terminal and the VFBP pin. |
| Inductor and current sensing | | |
| L1 | L=1000nH | Recommended inductor: Würth WE-HCM 7443310100. |
| R6, R7 | 1.05k Ω | DCR current-sense filter resistors. |
| C8, C9 | 820nF | DCR current-sense filter capacitor. |

Table 4.5 *Passive Components for the ZSPM1508 and ZSPM1509*

| Reference Designator | Component Value | Description |
|-------------------------------------|-----------------|--|
| Feedback divider | | |
| R4 | 1k Ω | Output voltage feedback divider bottom resistor. |
| R5 | 3.3k Ω | Output voltage feedback divider top resistor. Connect between the output terminal and the VFBP pin. |
| Inductor and current sensing | | |
| L1 | L=2.2 μ H | Recommended inductor: Würth WE-HCC 7443310220. |
| R6, R7 | 1180 Ω | DCR current-sense filter resistors. |
| C8, C9 | 470nF | DCR current-sense filter capacitor. |

Table 4.6 *Passive Components for the ZSPM1511, ZSPM1512, and ZSPM1513*

| Reference Designator | Component Value | Description |
|-------------------------------------|-----------------|---|
| Feedback divider | | |
| R4 | DNP | Output voltage feedback divider bottom resistor. Important: Do not place R4 for the ZSPM1511, ZSPM1512, and ZSPM1513. |
| R5 | 1.0k Ω | Output voltage feedback divider top resistor. Connect between the output terminal and the VFBP pin. |
| Inductor and current sensing | | |
| L1 | L= 680 η H | Recommended inductor: Würth WE-HCC 7443310068 |
| R6, R7 | 1.0k Ω | DCR current-sense filter resistors. |
| C8, C9 | 1.0 μ F | DCR current-sense filter capacitor. |

4.3. Output Voltage Feedback Components

The ZSPM15xx supports output voltage feedback via a resistive feedback divider. However, adding a high-frequency low-pass filter in the sense path is highly recommended to remove high-frequency disturbances from the sense signals. Placing these components as close as possible to the ZSPM15xx is recommended. For larger output voltages, a feedback divider is required. Using resistors with small tolerances is recommended to guarantee good output voltage accuracy.

Important: The feedback divider components specified in section 1.4 are mandatory if they are specified for the specific ZSPM15xx product. Components specified as DNP in section 1.4 must not be placed.

Figure 4.2 Output Voltage Sense Circuitry

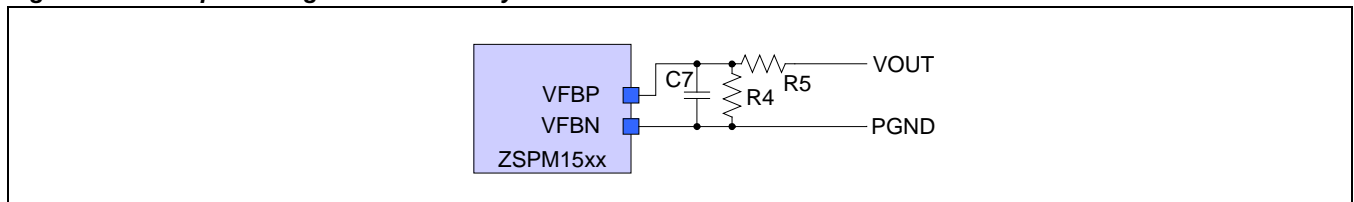

4.4. DCR Current Sensing Components

Figure 4.3 Inductor Current Sensing Using the DCR Method

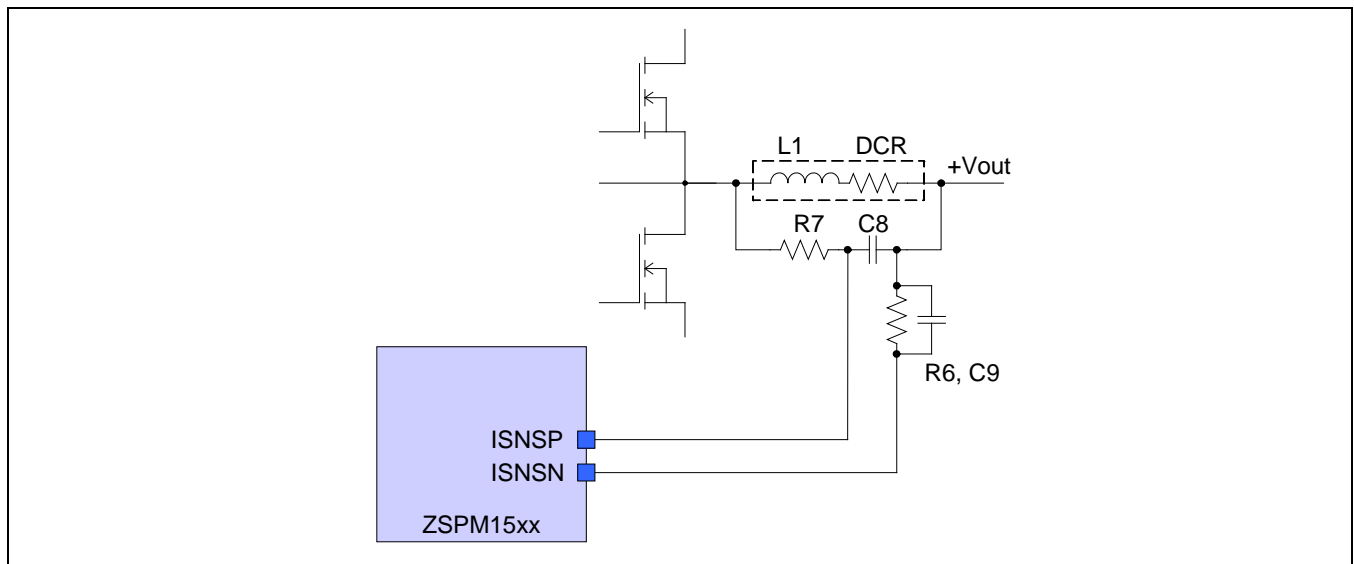

The ZSPM15xx supports the loss-less DCR current sense method. The equivalent DC resistance (DCR) of the inductor is used to measure the inductor current without adding any additional components in the power path. The technique is based on matching the time constants of the inductor and the parallel low-pass filter. Therefore the components (R6 and R7) and (C8 and C9) must be selected depending on the selected inductor.

For design guidance using one of the preselected power stages, refer to section 4.2.

Otherwise, the following procedure is recommended:

- 1.) Set $R7' = 1k\Omega$
- 2.) Calculate $C8' = L / (DCR * R7')$.
- 3.) Select capacitor $C8 = C9$ from the appropriate E-series close to $C8$.
- 4.) Recalculate $R6 = R7 = L / (DCR * C8)$ based on the capacitor selected for $C8$.

4.5. Input Voltage Sensing

The ZSPM15xx supports input voltage sensing for input voltage protection. Therefore a voltage divider between the input voltage and the VIN pin is required. An optional capacitor C10 can be connected to the VIN pin to help improve noise immunity. See Table 4.1 for the recommended values for R8, R9, and C10.

Figure 4.4 Input Voltage Sense Circuitry

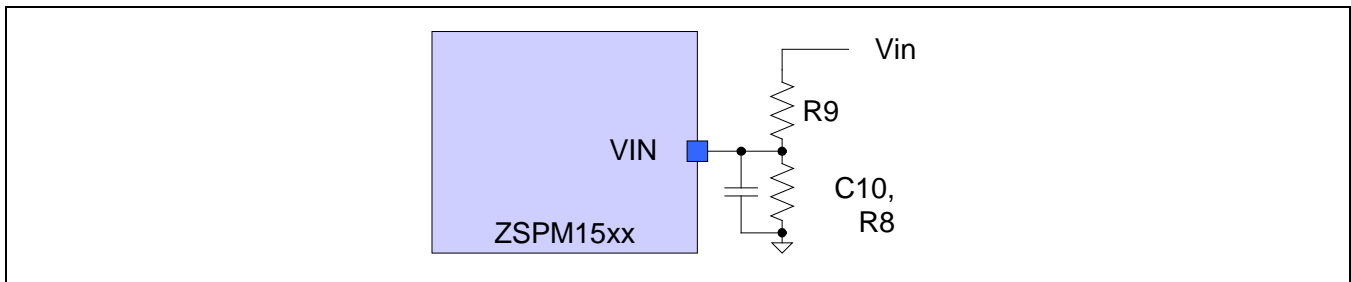

4.6. External Temperature Sensing

The ZSPM15xx features external temperature sensing via a PN-junction. Typically, a small signal transistor, such as the 3904, is used for this purpose. The sense elements should be placed thermally close to the inductor to allow accurate temperature measurement. For information about the required device parameters, refer to the electrical specification in section 1.3. An additional capacitor (C11, 100nF) can be used to improve noise performance.

Figure 4.5 External Temperature Sense Circuitry

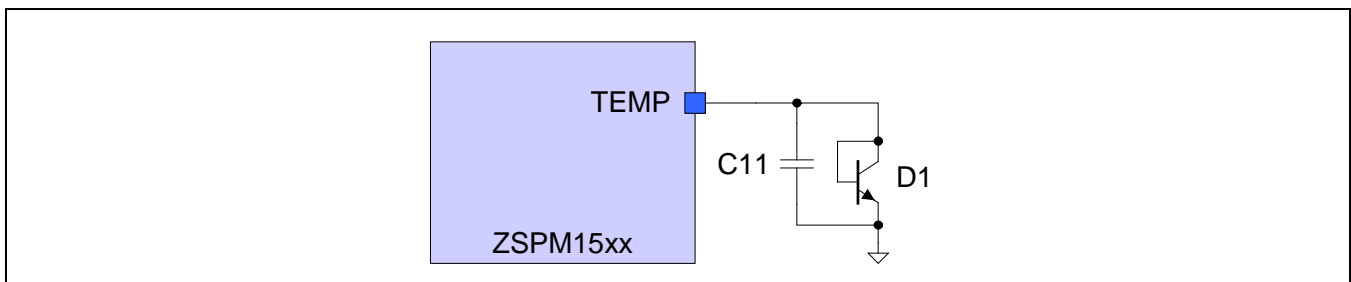

4.7. CONFIG0 – Over-Current Protection Threshold

The ZSPM15xx can be configured to support a wide range of different over-current protection (OCP) thresholds based on the user's selection for the inductor. The over-current threshold voltage between the ISNSP and ISNSN pins can be configured by using a pull-down resistor (R2) on the CONFIG0 pin. This voltage represents the over-current threshold because faults are detected by measuring the voltage across the DCR of the selected inductor. The different configuration options are listed in Table 4.7.

Table 4.7 ZSPM15xx – OCP Pin Strap Resistor Selection

| Index | Resistor Value Using the E96 Series | OCP Voltage Selection at 25°C | Index | Resistor Value Using the E96 Series | OCP Voltage Selection at 25°C |
|-------|-------------------------------------|-------------------------------|-------|-------------------------------------|-------------------------------|
| 0 | 0Ω | 3.0mV | 15 | 5.360kΩ | 20.0mV |
| 1 | 392Ω | 4.0mV | 16 | 6.040kΩ | 22.5mV |
| 2 | 576Ω | 5.0mV | 17 | 6.810kΩ | 25.0mV |
| 3 | 787Ω | 6.0mV | 18 | 7.680kΩ | 27.5mV |
| 4 | 1.000kΩ | 7.0mV | 19 | 8.660kΩ | 30.0mV |
| 5 | 1.240kΩ | 8.0mV | 20 | 9.530kΩ | 32.5mV |
| 6 | 1.500kΩ | 9.0mV | 21 | 10.50kΩ | 35.0mV |
| 7 | 1.780kΩ | 10.0mV | 22 | 11.80kΩ | 37.5mV |
| 8 | 2.100kΩ | 11.25mV | 23 | 13.00kΩ | 40.0mV |
| 9 | 2.430kΩ | 12.5mV | 24 | 14.30kΩ | 45.0mV |
| 10 | 2.800kΩ | 13.75mV | 25 | 15.80kΩ | 50.0mV |
| 11 | 3.240kΩ | 15.0mV | 26 | 17.40kΩ | 55.0mV |
| 12 | 3.740kΩ | 16.25mV | 27 | 19.10kΩ | 60.0mV |
| 13 | 4.220kΩ | 17.5mV | 28 | 21.00kΩ | 65.0mV |
| 14 | 4.750kΩ | 18.75mV | 29 | 23.20kΩ | 70.0mV |

Note that due to the temperature compensation feature, the ZSPM15xx over-current threshold should be based on the current sense signal at 25°C. Temperature drift is automatically compensated within the device.

Recommendation: For the selection of the over-current threshold voltage, include the tolerance of the inductor's DCR and take the parasitic effects of the circuit board layout into account.

4.8. CONFIG1 – Compensation Loop and Output Voltage Slew Rate

The ZSPM15xx controllers can be configured to operate over a wide range of output capacitance. Four ranges of output capacitance have been specified to match typical customer requirements (see Table 4.8). For each output capacitance range, an optimized compensation loop can be selected. The appropriate compensator should be selected based on the application requirements.

Typical performance measurements for both load transient performance and open-loop Bode plots can be found in section 5.

Note: Using less output capacitance than the minimum capacitance given in Table 4.8 is not recommended.

Table 4.8 Recommended Output Capacitor Ranges

| Capacitor Range | Ceramic Capacitor | Bulk Electrolytic Capacitors | Suitable Compensator |
|-----------------|---|--|----------------------|
| #1 | Minimum 200 μ F Maximum 500 μ F | None | Comp0 |
| #2 | Minimum 500 μ F Maximum 1000 μ F | None | Comp1 |
| #3 | Minimum 200 μ F Maximum 500 μ F | Minimum 2 x 470 μ F, 7m Ω ESR Maximum 4 x 470 μ F, 7m Ω ESR | Comp2 |
| #4 | Minimum 500 μ F Maximum 1000 μ F | Minimum 4 x 470 μ F, 7m Ω ESR Maximum 6 x 470 μ F, 7m Ω ESR | Comp3 |

To achieve the optimal performance for a given output capacitor range, one of four sets of compensation loop parameters, Comp0 to Comp3, should be selected with a resistor between the CONFIG1 and GND pins. The compensation loop parameters have been configured to ensure optimal transient performance and good control loop stability margins.

For each set of compensation loop parameters, there is a choice of seven slew rates for the output voltage during power-up. The selection of the slew rate can be used to limit the input current of the DC/DC converter while it is ramping up the output voltage. The current needed to charge the output capacitors increases in direct proportion to the slew rate.

Table 4.9 gives a complete list of the selectable compensation loop parameters and slew rates together with the equivalent pin-strap resistor values (R3) for the ZSPM1501 to ZSPM1506 and the ZSPM1511 to ZSPM1513. Table 4.10, Table 4.11, and Table 4.12 provide the values and settings for the ZSPM1507, ZSPM1508, and ZSPM1509 respectively.

Table 4.9 Compensator and VOUT Slew Rate Pin Strap Resistor Selection for the ZSPM1501 to ZSPM1506 and the ZSPM1511 to ZSPM1513

| Index | Resistor Value Using the E96 Series | Compensator | Vout Slew Rate | Index | Resistor Value Using the E96 Series | Compensator | Vout Slew Rate |
|-------|-------------------------------------|-------------------------------|----------------|-------|-------------------------------------|-------------------------------|----------------|
| 0 | 0Ω | Comp0 (Capacitor Range #1) | 2.700 V/ms | 14 | 4.750kΩ | Comp2 (Capacitor Range #3) | 2.700 V/ms |
| 1 | 392Ω | | 1.350 V/ms | 15 | 5.360kΩ | | 1.350 V/ms |
| 2 | 576Ω | | 0.675 V/ms | 16 | 6.040kΩ | | 0.675 V/ms |
| 3 | 787Ω | | 0.300 V/ms | 17 | 6.810kΩ | | 0.300 V/ms |
| 4 | 1.000kΩ | | 0.200 V/ms | 18 | 7.680kΩ | | 0.200 V/ms |
| 5 | 1.240kΩ | | 0.150 V/ms | 19 | 8.660kΩ | | 0.150 V/ms |
| 6 | 1.500kΩ | | 0.100 V/ms | 20 | 9.530kΩ | | 0.100 V/ms |
| 7 | 1.780kΩ | Comp1 (Capacitor Range #2) | 2.700 V/ms | 21 | 10.50kΩ | Comp3 (Capacitor Range #4) | 2.700 V/ms |
| 8 | 2.100kΩ | | 1.350 V/ms | 22 | 11.80kΩ | | 1.350 V/ms |
| 9 | 2.430kΩ | | 0.675 V/ms | 23 | 13.00kΩ | | 0.675 V/ms |
| 10 | 2.800kΩ | | 0.300 V/ms | 24 | 14.30kΩ | | 0.300 V/ms |
| 11 | 3.240kΩ | | 0.200 V/ms | 25 | 15.80kΩ | | 0.200 V/ms |
| 12 | 3.740kΩ | | 0.150 V/ms | 26 | 17.40kΩ | | 0.150 V/ms |
| 13 | 4.220kΩ | | 0.100 V/ms | 27 | 19.10kΩ | | 0.100 V/ms |

Table 4.10 Compensator and VOUT Slew Rate Pin Strap Resistor Selection for the ZSPM1507

| Index | Resistor Value Using the E96 Series | Compensator | Vout Slew Rate | Index | Resistor Value Using the E96 Series | Compensator | Vout Slew Rate |
|-------|-------------------------------------|-------------------------------|----------------|-------|-------------------------------------|-------------------------------|----------------|
| 0 | 0Ω | Comp0 (Capacitor Range #1) | 6.756 V/ms | 14 | 4.750kΩ | Comp2 (Capacitor Range #3) | 6.756 V/ms |
| 1 | 392Ω | | 3.378 V/ms | 15 | 5.360kΩ | | 3.378 V/ms |
| 2 | 576Ω | | 1.689 V/ms | 16 | 6.040kΩ | | 1.689 V/ms |
| 3 | 787Ω | | 0.750 V/ms | 17 | 6.810kΩ | | 0.750 V/ms |
| 4 | 1.000kΩ | | 0.517 V/ms | 18 | 7.680kΩ | | 0.517 V/ms |
| 5 | 1.240kΩ | | 0.374 V/ms | 19 | 8.660kΩ | | 0.374 V/ms |
| 6 | 1.500kΩ | | 0.250 V/ms | 20 | 9.530kΩ | | 0.250 V/ms |
| 7 | 1.780kΩ | Comp1 (Capacitor Range #2) | 6.756 V/ms | 21 | 10.50kΩ | Comp3 (Capacitor Range #4) | 6.756 V/ms |
| 8 | 2.100kΩ | | 3.378 V/ms | 22 | 11.80kΩ | | 3.378 V/ms |
| 9 | 2.430kΩ | | 1.689 V/ms | 23 | 13.00kΩ | | 1.689 V/ms |
| 10 | 2.800kΩ | | 0.750 V/ms | 24 | 14.30kΩ | | 0.750 V/ms |
| 11 | 3.240kΩ | | 0.517 V/ms | 25 | 15.80kΩ | | 0.517 V/ms |
| 12 | 3.740kΩ | | 0.374 V/ms | 26 | 17.40kΩ | | 0.374 V/ms |
| 13 | 4.220kΩ | | 0.250 V/ms | 27 | 19.10kΩ | | 0.250 V/ms |

Table 4.11 Compensator and VOUT Slew Rate Pin Strap Resistor Selection for the ZSPM1508

| Index | Resistor Value Using the E96 Series | Compensator | Vout Slew Rate | Index | Resistor Value Using the E96 Series | Compensator | Vout Slew Rate |
|-------|-------------------------------------|-------------------------------|----------------|-------|-------------------------------------|-------------------------------|----------------|
| 0 | 0Ω | Comp0 (Capacitor Range #1) | 2.896 V/ms | 14 | 4.750kΩ | Comp2 (Capacitor Range #3) | 2.896 V/ms |
| 1 | 392Ω | | 1.659 V/ms | 15 | 5.360kΩ | | 1.659 V/ms |
| 2 | 576Ω | | 1.051 V/ms | 16 | 6.040kΩ | | 1.051 V/ms |
| 3 | 787Ω | | 0.827 V/ms | 17 | 6.810kΩ | | 0.827 V/ms |
| 4 | 1.000kΩ | | 0.643 V/ms | 18 | 7.680kΩ | | 0.643 V/ms |
| 5 | 1.240kΩ | | 0.428 V/ms | 19 | 8.660kΩ | | 0.428 V/ms |
| 6 | 1.500kΩ | | 0.330 V/ms | 20 | 9.530kΩ | | 0.330 V/ms |
| 7 | 1.780kΩ | Comp1 (Capacitor Range #2) | 2.896 V/ms | 21 | 10.50kΩ | Comp3 (Capacitor Range #4) | 2.896 V/ms |
| 8 | 2.100kΩ | | 1.659 V/ms | 22 | 11.80kΩ | | 1.659 V/ms |
| 9 | 2.430kΩ | | 1.051 V/ms | 23 | 13.00kΩ | | 1.051 V/ms |
| 10 | 2.800kΩ | | 0.827 V/ms | 24 | 14.30kΩ | | 0.827 V/ms |
| 11 | 3.240kΩ | | 0.643 V/ms | 25 | 15.80kΩ | | 0.643 V/ms |
| 12 | 3.740kΩ | | 0.428 V/ms | 26 | 17.40kΩ | | 0.428 V/ms |
| 13 | 4.220kΩ | | 0.330 V/ms | 27 | 19.10kΩ | | 0.330 V/ms |

Table 4.12 Compensator and VOUT Slew Rate Pin Strap Resistor Selection for the ZSPM1509

| Index | Resistor Value Using the E96 Series | Compensator | Vout Slew Rate | Index | Resistor Value Using the E96 Series | Compensator | Vout Slew Rate |
|-------|-------------------------------------|-------------------------------|----------------|-------|-------------------------------------|-------------------------------|----------------|
| 0 | 0Ω | Comp0 (Capacitor Range #1) | 2.907 V/ms | 14 | 4.750kΩ | Comp2 (Capacitor Range #3) | 2.907 V/ms |
| 1 | 392Ω | | 1.938 V/ms | 15 | 5.360kΩ | | 1.938 V/ms |
| 2 | 576Ω | | 1.656 V/ms | 16 | 6.040kΩ | | 1.656 V/ms |
| 3 | 787Ω | | 1.160 V/ms | 17 | 6.810kΩ | | 1.160 V/ms |
| 4 | 1.000kΩ | | 0.967 V/ms | 18 | 7.680kΩ | | 0.967 V/ms |
| 5 | 1.240kΩ | | 0.683 V/ms | 19 | 8.660kΩ | | 0.683 V/ms |
| 6 | 1.500kΩ | | 0.504 V/ms | 20 | 9.530kΩ | | 0.504 V/ms |
| 7 | 1.780kΩ | Comp1 (Capacitor Range #2) | 2.907 V/ms | 21 | 10.50kΩ | Comp3 (Capacitor Range #4) | 2.907 V/ms |
| 8 | 2.100kΩ | | 1.938 V/ms | 22 | 11.80kΩ | | 1.938 V/ms |
| 9 | 2.430kΩ | | 1.656 V/ms | 23 | 13.00kΩ | | 1.656 V/ms |
| 10 | 2.800kΩ | | 1.160 V/ms | 24 | 14.30kΩ | | 1.160 V/ms |
| 11 | 3.240kΩ | | 0.967 V/ms | 25 | 15.80kΩ | | 0.967 V/ms |
| 12 | 3.740kΩ | | 0.683 V/ms | 26 | 17.40kΩ | | 0.683 V/ms |
| 13 | 4.220kΩ | | 0.504 V/ms | 27 | 19.10kΩ | | 0.504 V/ms |

5 Typical Performance Data

This section gives typical performance data for the individual products in the ZSPM15xx family. The pre-programmed compensation loop parameters for the ZSPM15xx have been designed to ensure stability and optimal transient performance for the specified inductance in combination with one of the four output capacitor ranges (see Table 4.8).

The transient load steps have been generated with a load resistor and a power MOSFET located on the same circuit board as the ZSPM15xx and the recommended reference layout. The Evaluation Kit for the specific ZSPM15xx product can be used to further evaluate the performance of the ZSPM15xx for the four output capacitor ranges.

5.1. ZSPM1501 – Typical Load Transient Response – Capacitor Range #1 – Comp0

Test conditions: $V_{IN} = 12.0V$, $V_{OUT} = 0.85V$

Minimum output capacitance: $2 \times 100\mu F/6.3V \text{ X5R}$

Maximum output capacitance: $4 \times 100\mu F/6.3V \text{ X5R} + 2 \times 47\mu F/10V \text{ X7R}$

Figure 5.1 ZSPM1501 with Comp0; 5A to 15A Load Step; and Min. Capacitance

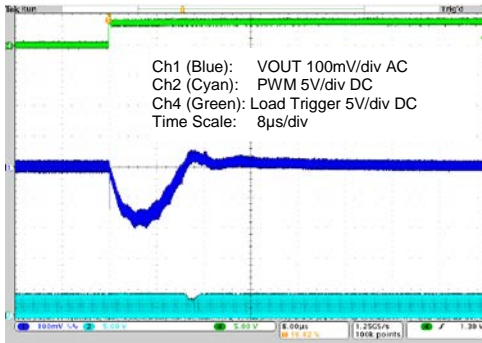

Figure 5.2 ZSPM1501 with Comp0; 15A to 5A Load Step; and Min. Capacitance

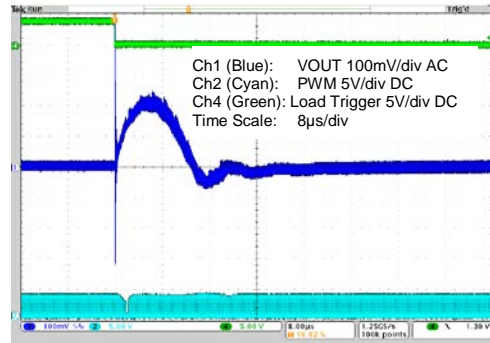

Figure 5.3 ZSPM1501 with Comp0; 5A to 15A Load Step; and Max. Capacitance

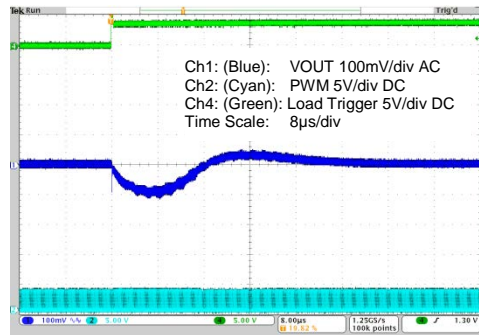

Figure 5.4 ZSPM1501 with Comp0; 15A to 5A Load Step; and Max. Capacitance

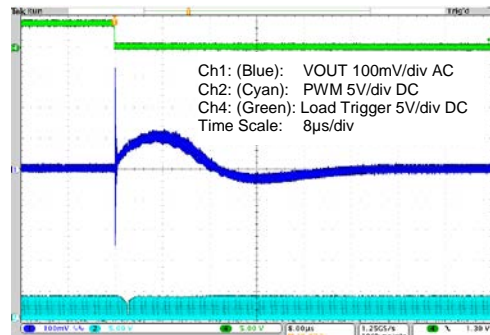
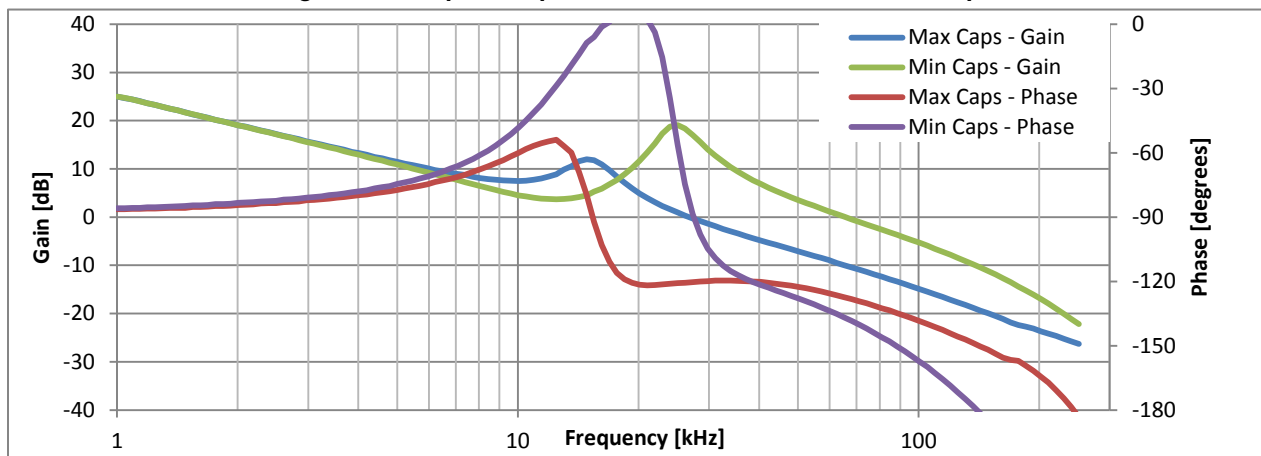

Figure 5.5 Open Loop Bode Plots for ZSPM1501 with Comp0



5.2. ZSPM1501 – Typical Load Transient Response – Capacitor Range #2 – Comp1

Test conditions: $V_{IN} = 12.0V$, $V_{OUT} = 0.85V$

Minimum output capacitance: $5 \times 100\mu F/6.3V \text{ X5R}$

Maximum output capacitance: $8 \times 100\mu F/6.3V \text{ X5R} + 4 \times 47\mu F/10V \text{ X7R}$

Figure 5.6 ZSPM1501 with Comp1; 5A to 15A Load Step; and Min. Capacitance

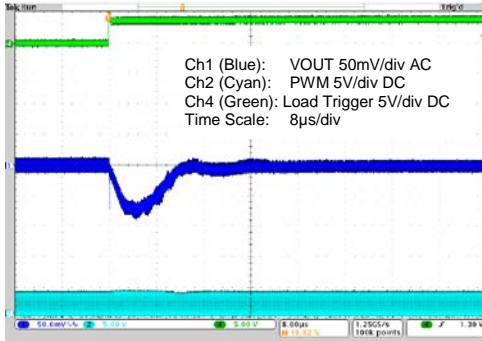

Figure 5.7 ZSPM1501 with Comp1; 15A to 5A Load Step; and Min. Capacitance

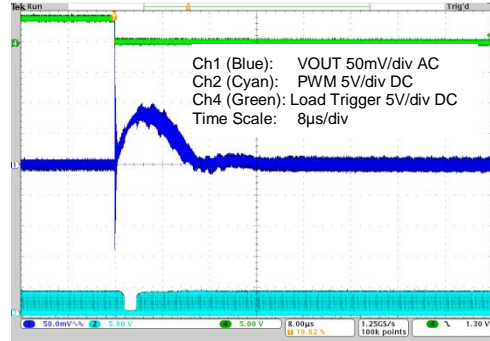

Figure 5.8 ZSPM1501 with Comp1; 5A to 15A Load Step; and Max. Capacitance

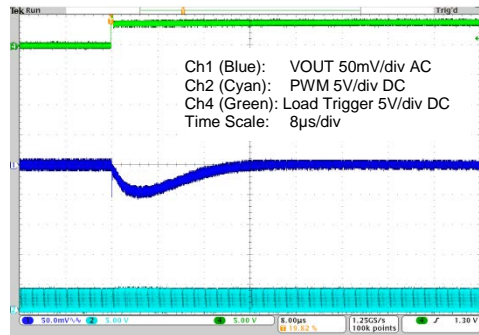

Figure 5.9 ZSPM1501 with Comp1; 15A to 5A Load Step; and Max. Capacitance

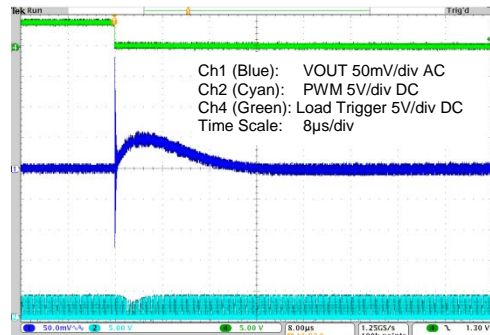
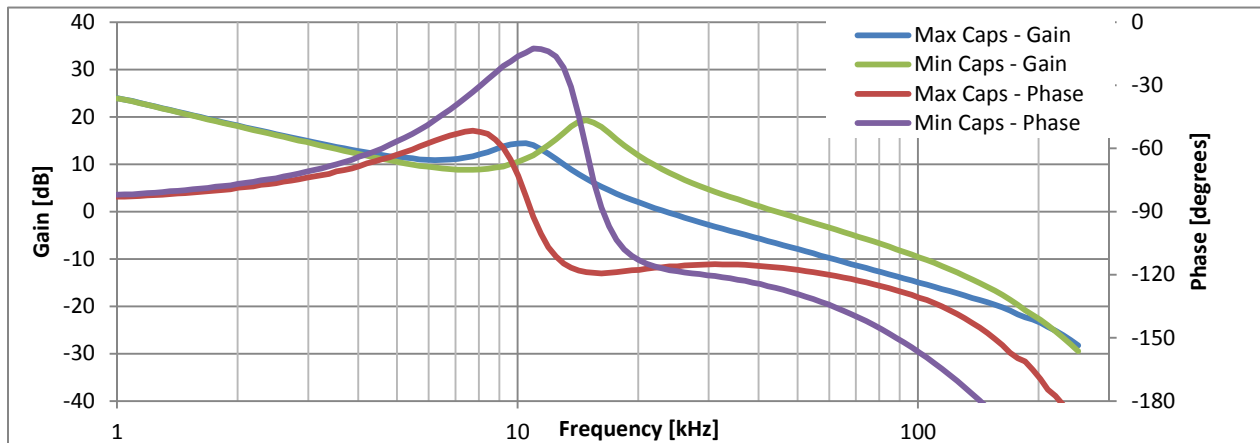

Figure 5.10 Open Loop Bode Plots for ZSPM1501 with Comp1



5.3. ZSPM1501 – Typical Load Transient Response – Capacitor Range #3 – Comp2

Test conditions: $V_{IN} = 12.0V$, $V_{OUT} = 0.85V$

Minimum output capacitance: $2 \times 100\mu F/6.3V \text{ X5R} + 2 \times 470\mu F/7m\Omega$

Maximum output capacitance: $4 \times 100\mu F/6.3V \text{ X5R} + 2 \times 47\mu F/10V \text{ X7R} + 4 \times 470\mu F/7m\Omega$

Figure 5.11 ZSPM1501 with Comp2; 5A to 15A Load Step; and Min. Capacitance

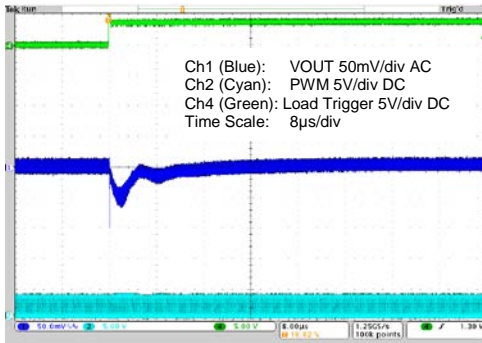

Figure 5.12 ZSPM1501 with Comp2; 15A to 5A Load Step; and Min. Capacitance

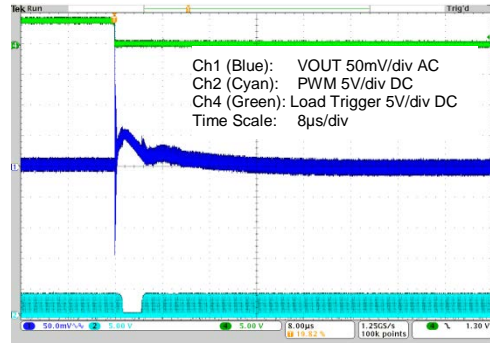

Figure 5.13 ZSPM1501 with Comp2; 5A to 15A Load Step; and Max. Capacitance

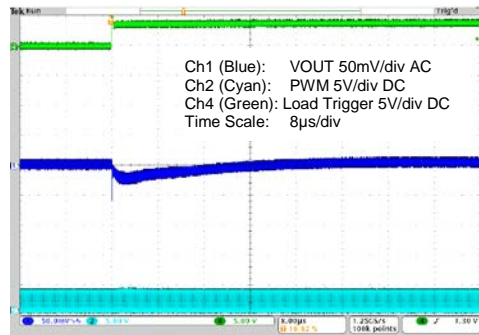

Figure 5.14 ZSPM1501 with Comp2; 15A to 5A Load Step; and Max. Capacitance

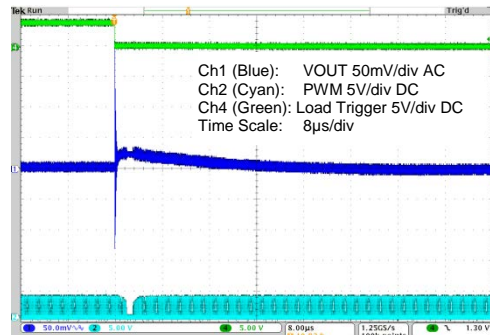
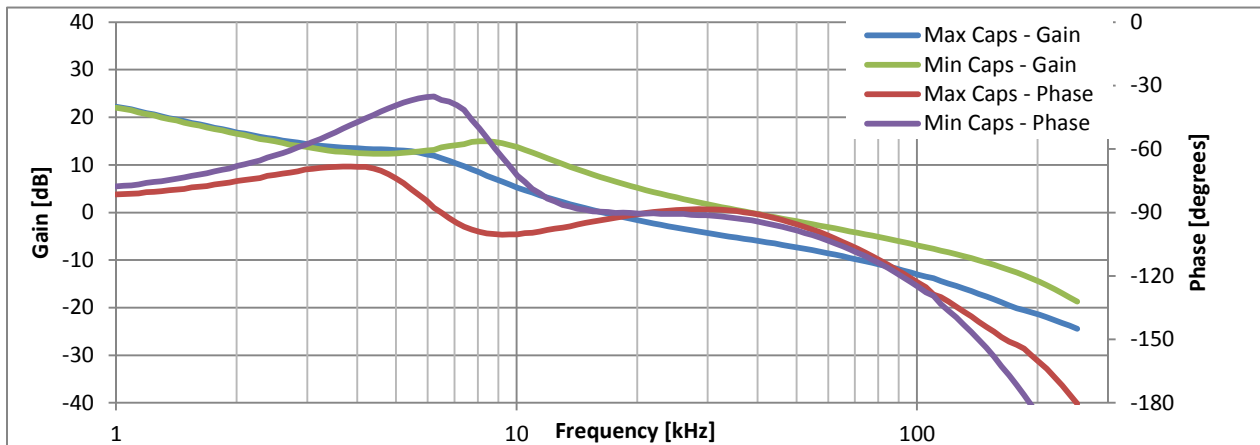

Figure 5.15 Open Loop Bode Plots for ZSPM1501 with Comp2



5.4. ZSPM1501 – Typical Load Transient Response – Capacitor Range #4 – Comp3

Test conditions: $V_{IN} = 12.0V$, $V_{OUT} = 0.85V$

Minimum output capacitance: $5 \times 100\mu F/6.3V \text{ X5R} + 4 \times 470\mu F/7m\Omega$

Maximum output capacitance: $8 \times 100\mu F/6.3V \text{ X5R} + 4 \times 47\mu F/10V \text{ X7R} + 6 \times 470\mu F/7m\Omega$

Figure 5.16 ZSPM1501 with Comp3; 5A to 15A Load Step; and Min. Capacitance

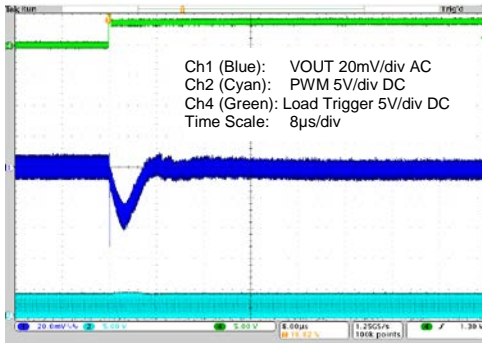

Figure 5.17 ZSPM1501 with Comp3; 15A to 5A Load Step; and Min. Capacitance

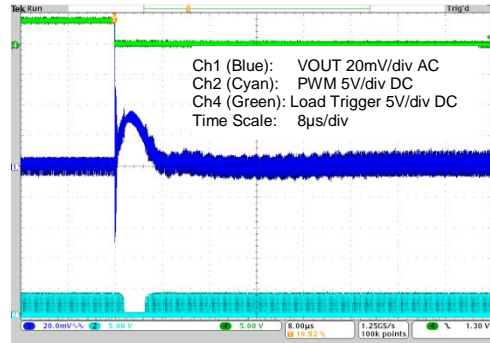

Figure 5.18 ZSPM1501 with Comp3; 5A to 15A Load Step; and Max. Capacitance

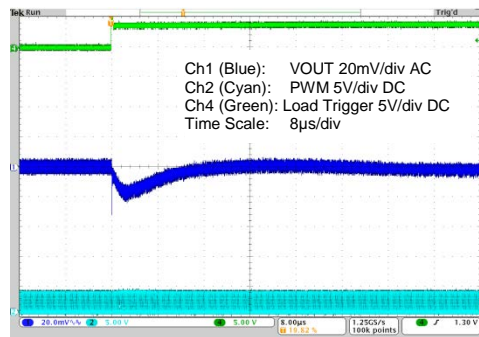
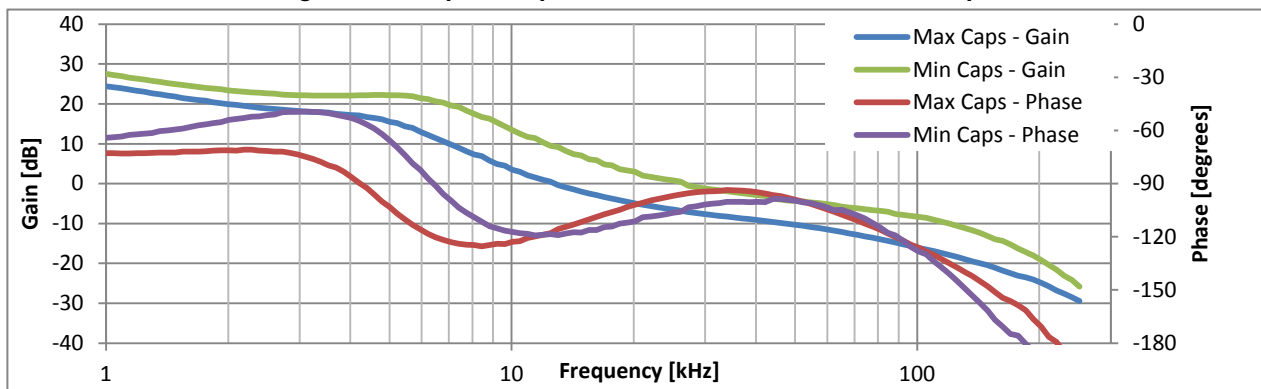

Figure 5.19 ZSPM1501 with Comp3; 15A to 5A Load Step; and Max. Capacitance



Figure 5.20 Open Loop Bode Plots for ZSPM1501 with Comp3



5.5. ZSPM1502 – Typical Load Transient Response – Capacitor Range #1 – Comp0

Test conditions: $V_{IN} = 12.0V$, $V_{OUT} = 1.00V$

Minimum output capacitance: $2 \times 100\mu F/6.3V \text{ X5R}$

Maximum output capacitance: $4 \times 100\mu F/6.3V \text{ X5R} + 2 \times 47\mu F/10V \text{ X7R}$

Figure 5.21 ZSPM1502 with Comp0; 5A to 15A Load Step; and Min. Capacitance

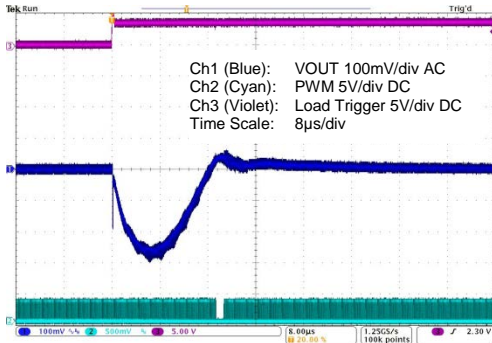

Figure 5.22 ZSPM1502 with Comp0; 15A to 5A Load Step; and Min. Capacitance

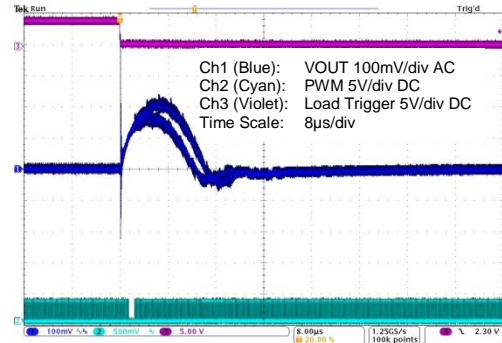

Figure 5.23 ZSPM1502 with Comp0; 5A to 15A Load Step; and Max. Capacitance

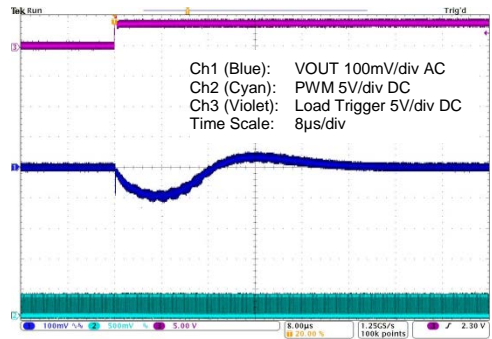

Figure 5.24 ZSPM1502 with Comp0; 15A to 5A Load Step; and Max. Capacitance

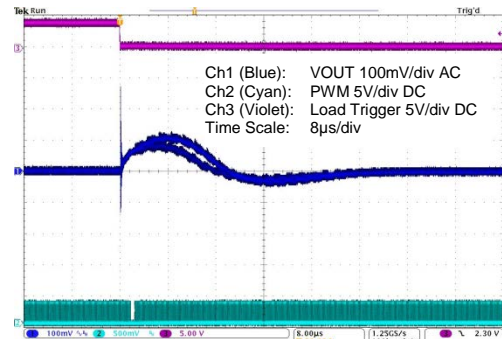
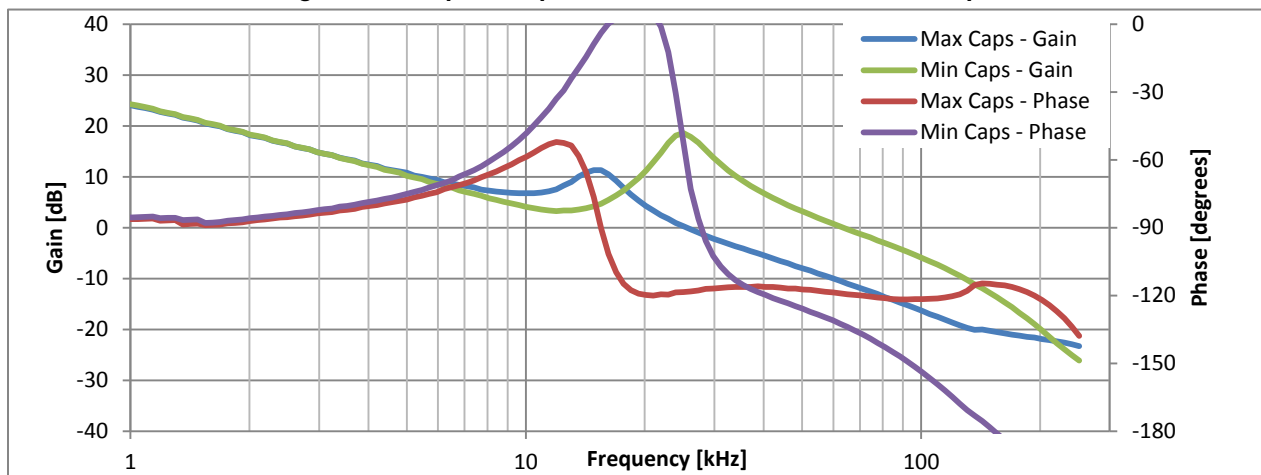

Figure 5.25 Open Loop Bode Plots for ZSPM1502 with Comp0



5.6. ZSPM1502 – Typical Load Transient Response – Capacitor Range #2 – Comp1

Test conditions: $V_{IN} = 12.0V$, $V_{OUT} = 1.00V$

Minimum output capacitance: $5 \times 100\mu F/6.3V \text{ X5R}$

Maximum output capacitance: $8 \times 100\mu F/6.3V \text{ X5R} + 4 \times 47\mu F/10V \text{ X7R}$

Figure 5.26 ZSPM1502 with Comp1; 5A to 15A Load Step; and Min. Capacitance

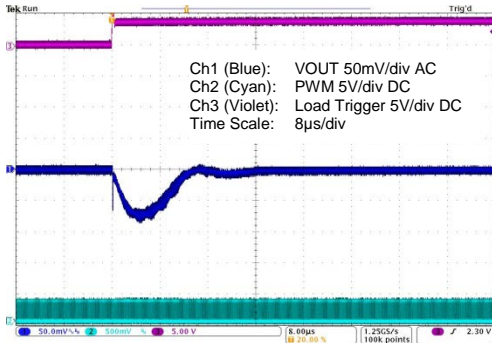

Figure 5.27 ZSPM1502 with Comp1; 15A to 5A Load Step; and Min. Capacitance

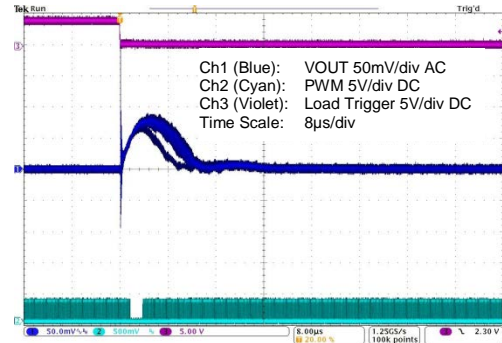

Figure 5.28 ZSPM1502 with Comp1; 5A to 15A Load Step; and Max. Capacitance

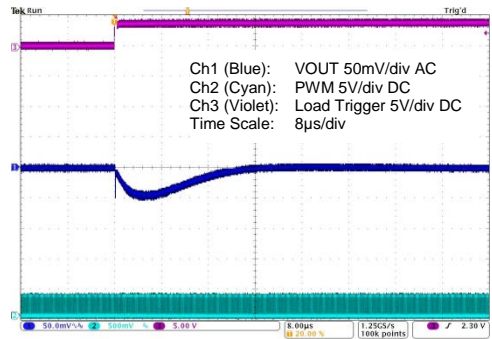

Figure 5.29 ZSPM1502 with Comp1; 15A to 5A Load Step; and Max. Capacitance

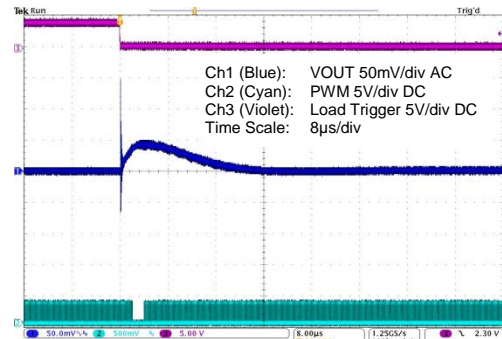
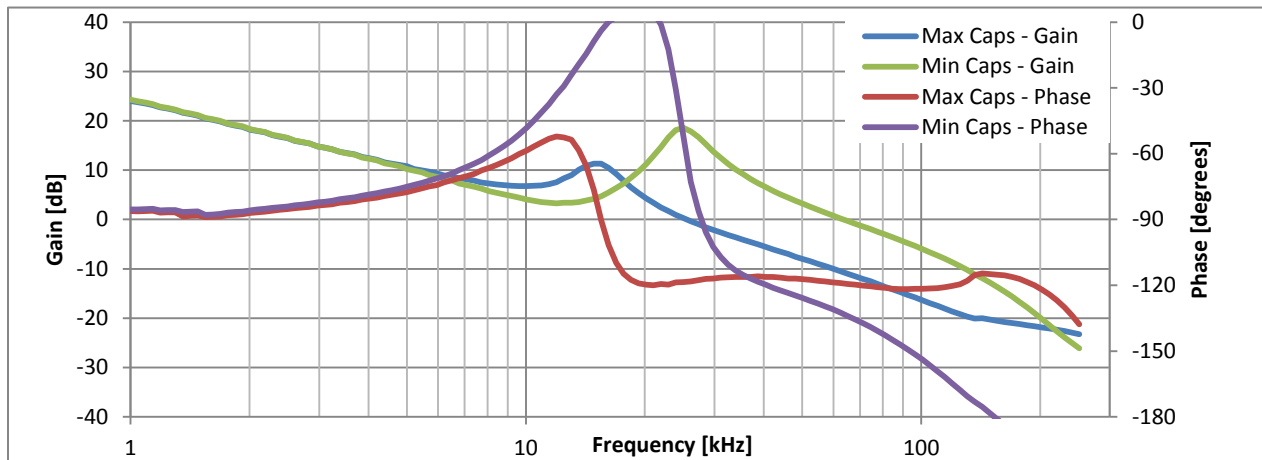

Figure 5.30 Open Loop Bode Plots for ZSPM1502 with Comp1



5.7. ZSPM1502 – Typical Load Transient Response – Capacitor Range #3 – Comp2

Test conditions: $V_{IN} = 12.0V$, $V_{OUT} = 1.00V$

Minimum output capacitance: $2 \times 100\mu F/6.3V \text{ X5R} + 2 \times 470\mu F/7m\Omega$

Maximum output capacitance: $4 \times 100\mu F/6.3V \text{ X5R} + 2 \times 47\mu F/10V \text{ X7R} + 4 \times 470\mu F/7m\Omega$

Figure 5.31 ZSPM1502 with Comp2; 5A to 15A Load Step; and Min. Capacitance

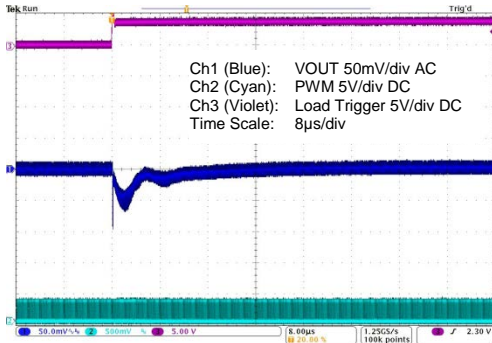

Figure 5.32 ZSPM1502 with Comp2; 15A to 5A Load Step; and Min. Capacitance

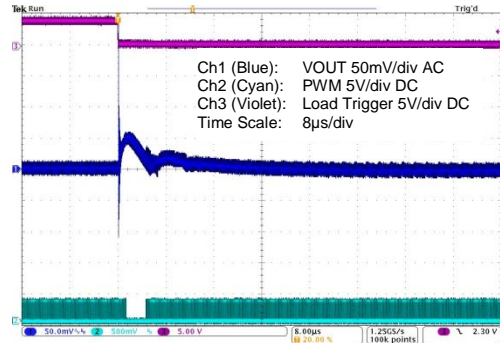

Figure 5.33 ZSPM1502 with Comp2; 5A to 15A Load Step; and Max. Capacitance

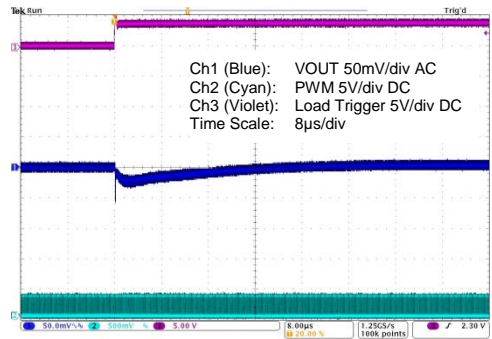

Figure 5.34 ZSPM1502 with Comp2; 15A to 5A Load Step; and Max. Capacitance

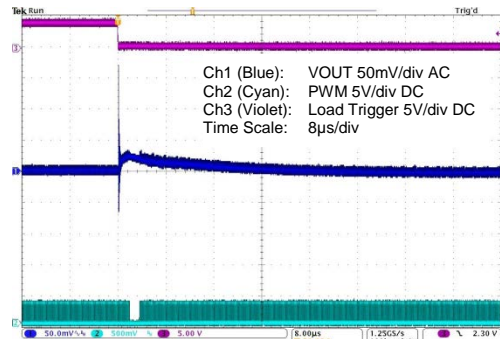
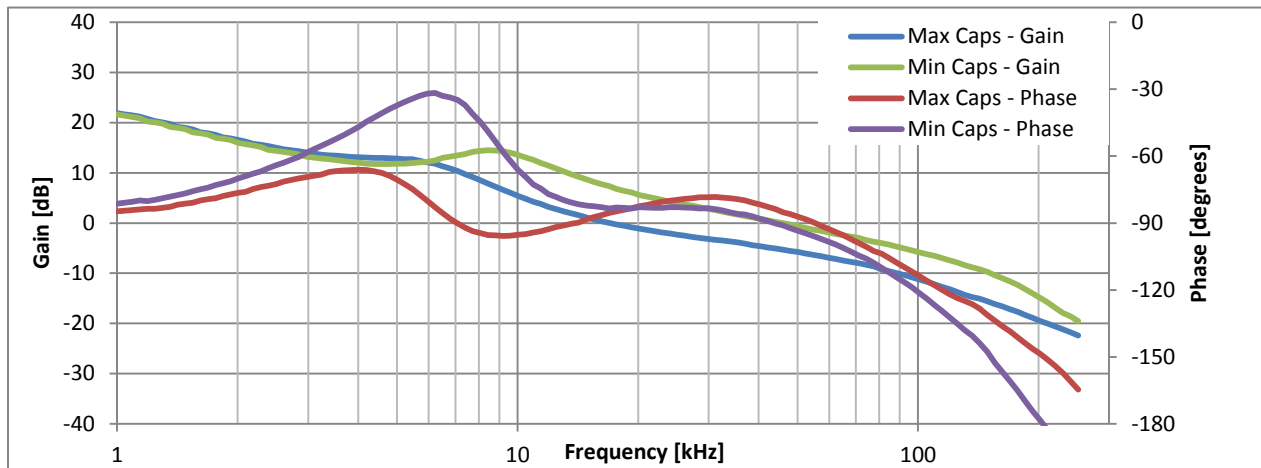

Figure 5.35 Open Loop Bode Plots for ZSPM1502 with Comp2



5.8. ZSPM1502 – Typical Load Transient Response – Capacitor Range #4 – Comp3

Test conditions: $V_{IN} = 12.0V$, $V_{OUT} = 1.00V$

Minimum output capacitance: $5 \times 100\mu F/6.3V \text{ X5R} + 4 \times 470\mu F/7m\Omega$

Maximum output capacitance: $8 \times 100\mu F/6.3V \text{ X5R} + 4 \times 47\mu F/10V \text{ X7R} + 6 \times 470\mu F/7m\Omega$

Figure 5.36 ZSPM1502 with Comp3; 5A to 15A Load Step; and Min. Capacitance

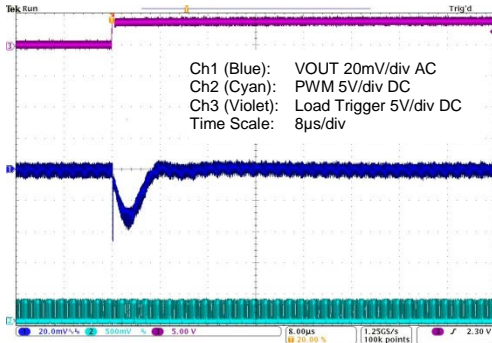

Figure 5.37 ZSPM1502 with Comp3; 15A to 5A Load Step; and Min. Capacitance

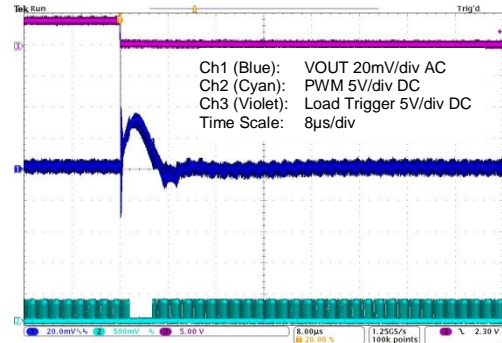

Figure 5.38 ZSPM1502 with Comp3; 5A to 15A Load Step; and Max. Capacitance

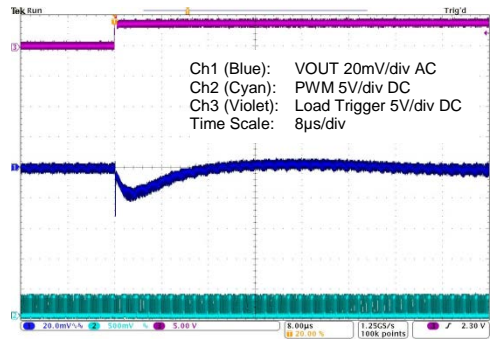

Figure 5.39 ZSPM1502 with Comp3; 15A to 5A Load Step; and Max. Capacitance

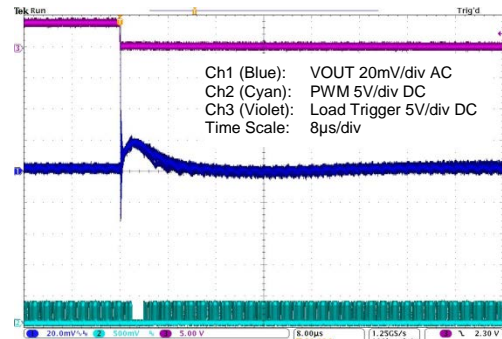
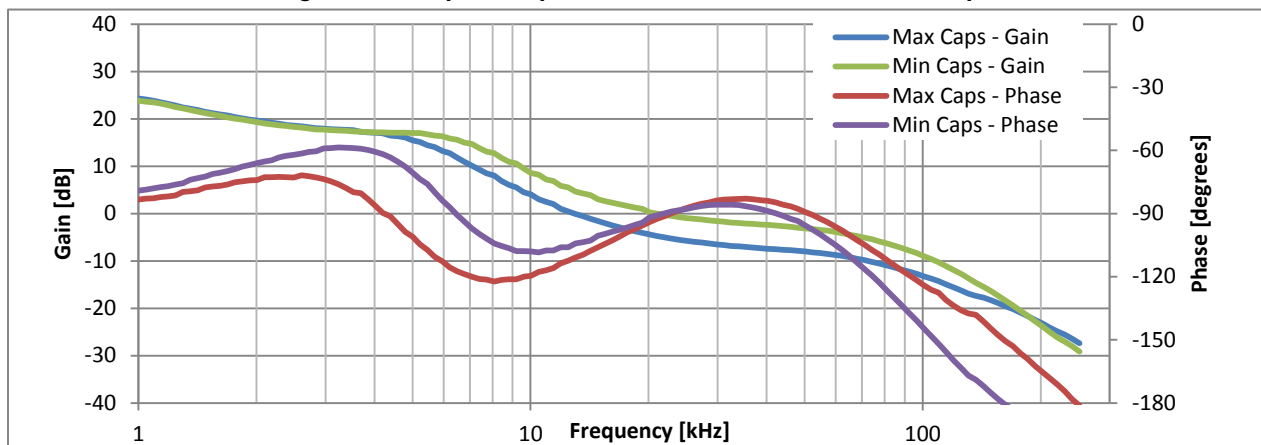

Figure 5.40 Open Loop Bode Plots for ZSPM1502 with Comp3



5.9. ZSPM1503 – Typical Load Transient Response – Capacitor Range #1 – Comp0

Test conditions: $V_{IN} = 12.0V$, $V_{OUT} = 1.20V$

Minimum output capacitance: $2 \times 100\mu F/6.3V \text{ X5R}$

Maximum output capacitance: $4 \times 100\mu F/6.3V \text{ X5R} + 2 \times 47\mu F/10V \text{ X7R}$

Figure 5.41 ZSPM1503 with Comp0; 5A to 15A Load Step; and Min. Capacitance

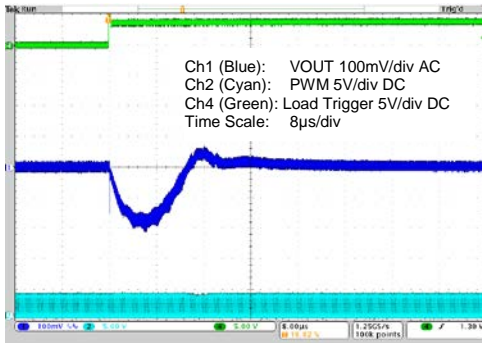

Figure 5.42 ZSPM1503 with Comp0; 15A to 5A Load Step; and Min. Capacitance

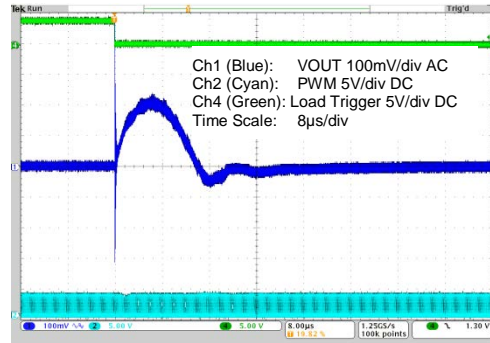

Figure 5.43 ZSPM1503 with Comp0; 5A to 15A Load Step; and Max. Capacitance

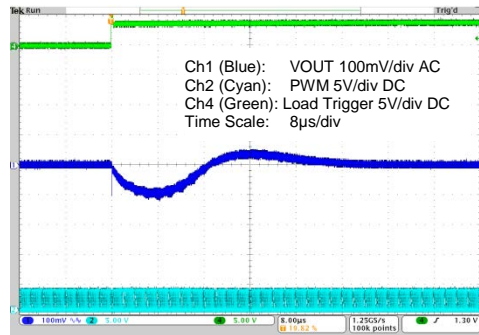

Figure 5.44 ZSPM1503 with Comp0; 15A to 5A Load Step; and Max. Capacitance

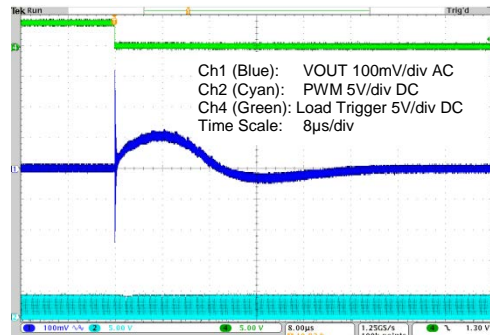
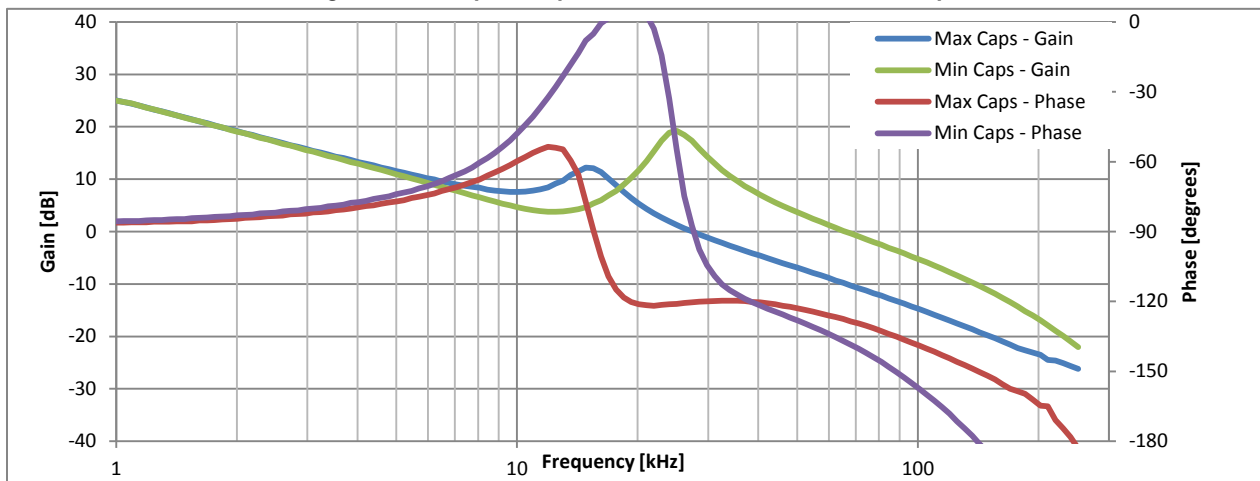

Figure 5.45 Open Loop Bode Plots for ZSPM1503 with Comp0



5.10. ZSPM1503 – Typical Load Transient Response – Capacitor Range #2 – Comp1

Test conditions: $V_{IN} = 12.0V$, $V_{OUT} = 1.20V$

Minimum output capacitance: $5 \times 100\mu F/6.3V \text{ X5R}$

Maximum output capacitance: $8 \times 100\mu F/6.3V \text{ X5R} + 4 \times 47\mu F/10V \text{ X7R}$

Figure 5.46 ZSPM1503 with Comp1; 5A to 15A Load Step; and Min. Capacitance

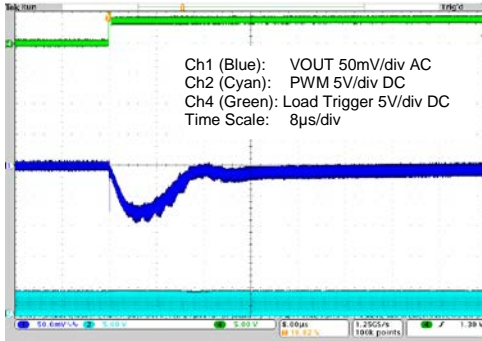

Figure 5.47 ZSPM1503 with Comp1; 15A to 5A Load Step; and Min. Capacitance

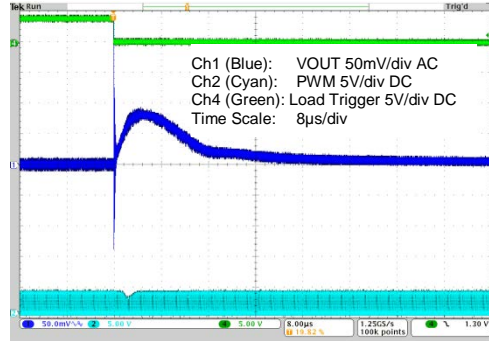

Figure 5.48 ZSPM1503 with Comp1; 5 to 15A Load Step; and Max. Capacitance

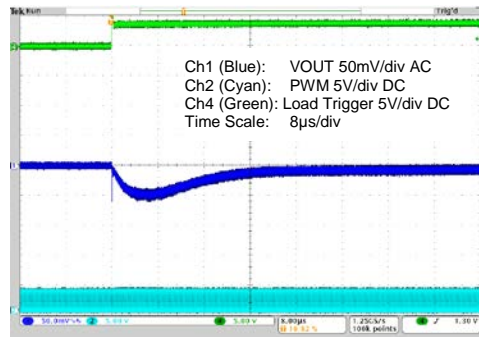

Figure 5.49 ZSPM1503 with Comp1; 15 to 5A Load Step; and Max. Capacitance

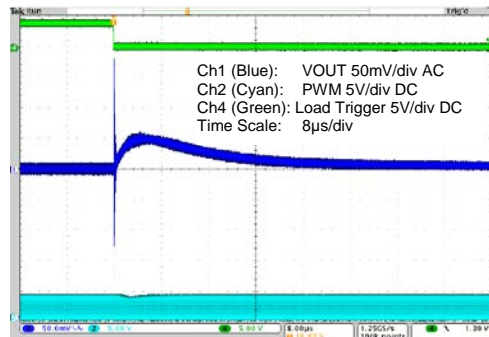
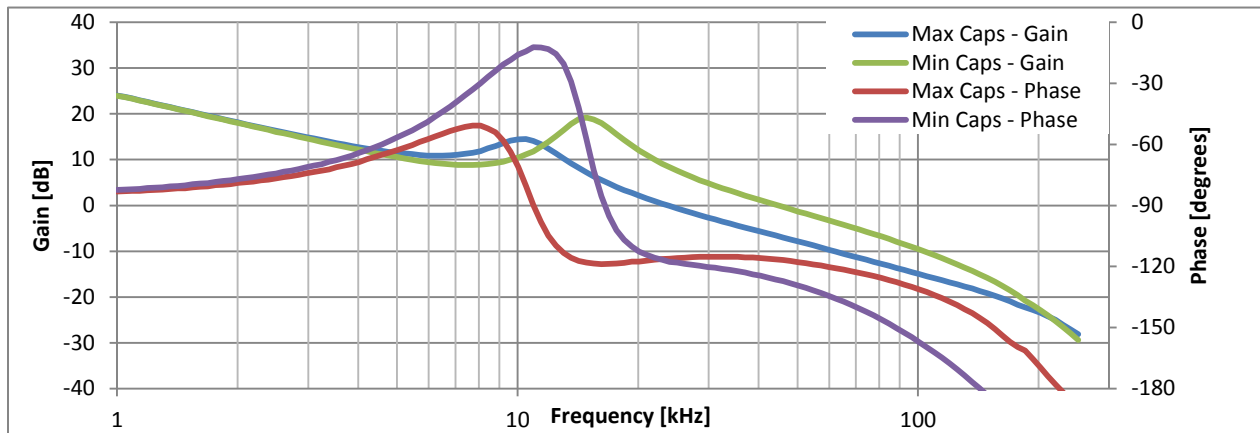

Figure 5.50 Open Loop Bode Plots for ZSPM1503 with Comp1



5.11. ZSPM1503 – Typical Load Transient Response – Capacitor Range #3 – Comp2

Test conditions: $V_{IN} = 12.0V$, $V_{OUT} = 1.20V$

Minimum output capacitance: $2 \times 100\mu F/6.3V \text{ X5R} + 2 \times 470\mu F/7m\Omega$

Maximum output capacitance: $4 \times 100\mu F/6.3V \text{ X5R} + 2 \times 47\mu F/10V \text{ X7R} + 4 \times 470\mu F/7m\Omega$

Figure 5.51 ZSPM1503 with Comp2; 5A to 15A Load Step; and Min. Capacitance

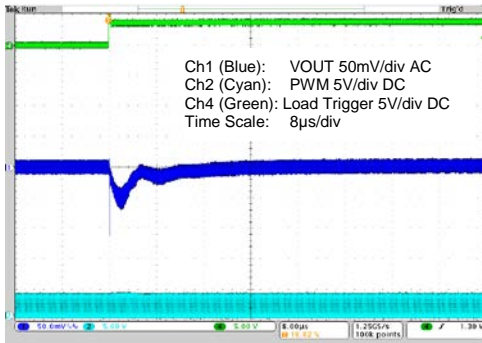

Figure 5.52 ZSPM1503 with Comp2; 15A to 5A Load Step; and Min. Capacitance

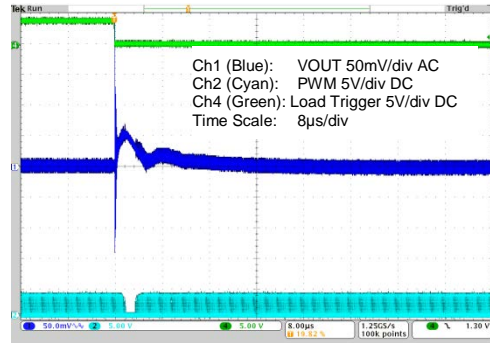

Figure 5.53 ZSPM1503 with Comp2; 5A to 15A Load Step; and Max. Capacitance

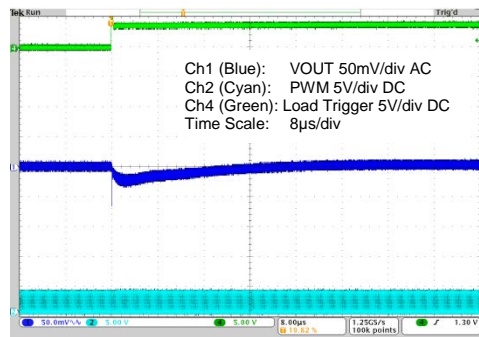

Figure 5.54 ZSPM1503 with Comp2; 15A to 5A Load Step; and Max. Capacitance

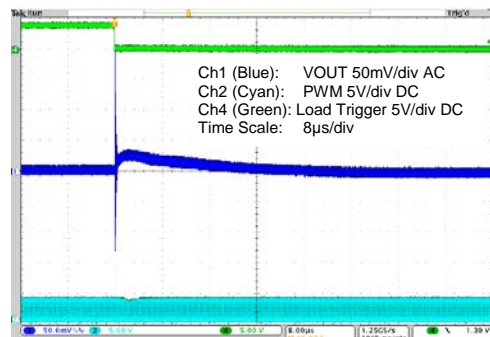
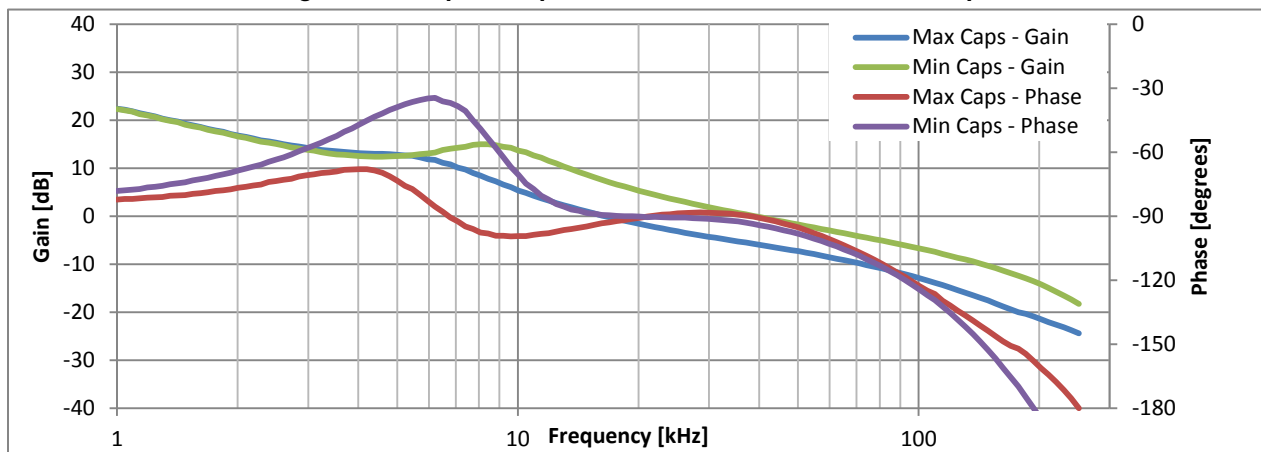

Figure 5.55 Open Loop Bode Plots for ZSPM1503 with Comp2



5.12. ZSPM1503 – Typical Load Transient Response – Capacitor Range #4 – Comp3

Test conditions: $V_{IN} = 12.0V$, $V_{OUT} = 1.20V$

Minimum output capacitance: $5 \times 100\mu F/6.3V \text{ X5R} + 4 \times 470\mu F/7m\Omega$

Maximum output capacitance: $8 \times 100\mu F/6.3V \text{ X5R} + 4 \times 47\mu F/10V \text{ X7R} + 6 \times 470\mu F/7m\Omega$

Figure 5.56 ZSPM1503 with Comp3; 5A to 15A Load Step; and Min. Capacitance

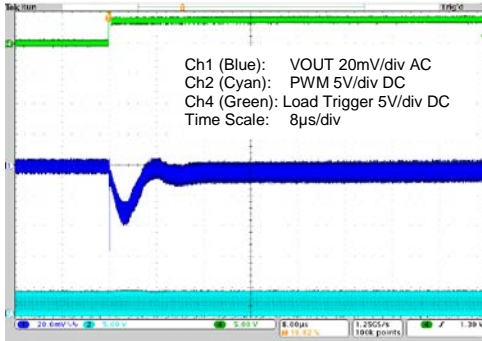

Figure 5.57 ZSPM1503 with Comp3; 15A to 5A Load Step; and Min. Capacitance

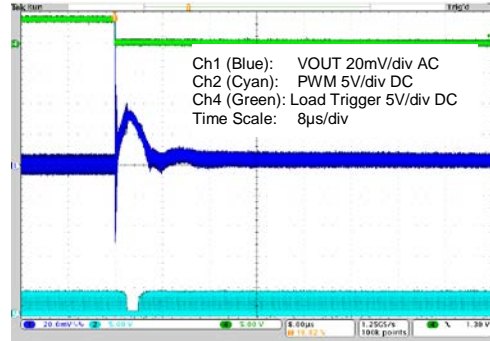

Figure 5.58 ZSPM1503 with Comp3; 5A to 15A Load Step; and Max. Capacitance

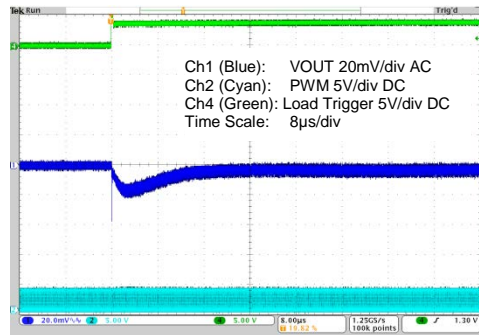

Figure 5.59 ZSPM1503 with Comp3; 15A to 5A Load Step; and Max. Capacitance

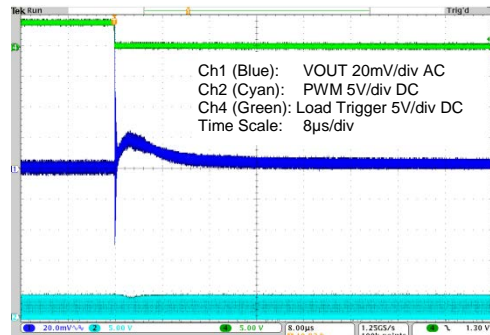
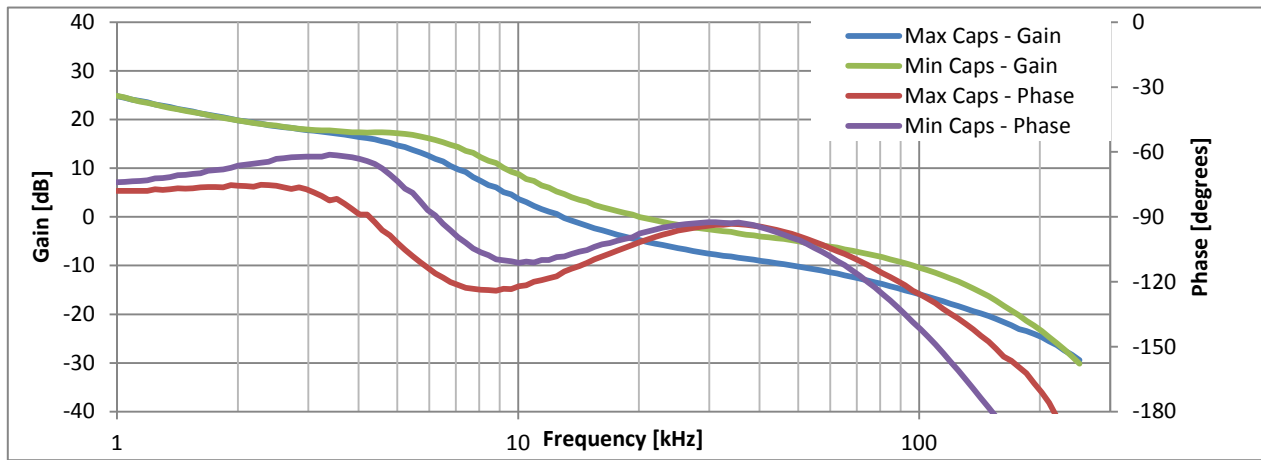

Figure 5.60 Open Loop Bode Plots for ZSPM1503 with Comp3



5.13. ZSPM1504 – Typical Load Transient Response – Capacitor Range #1 – Comp0

Test conditions: $V_{IN} = 12.0V$, $V_{OUT} = 1.50V$

Minimum output capacitance: $2 \times 100\mu F/6.3V \text{ X5R}$

Maximum output capacitance: $4 \times 100\mu F/6.3V \text{ X5R} + 2 \times 47\mu F/10V \text{ X7R}$

Figure 5.61 ZSPM1504 with Comp0; 5A to 15A Load Step; and Min. Capacitance

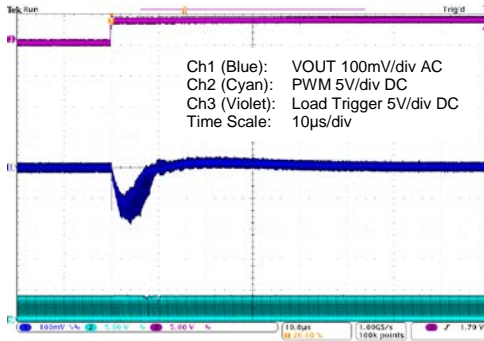

Figure 5.62 ZSPM1504 with Comp0; 15A to 5A Load Step; and Min. Capacitance

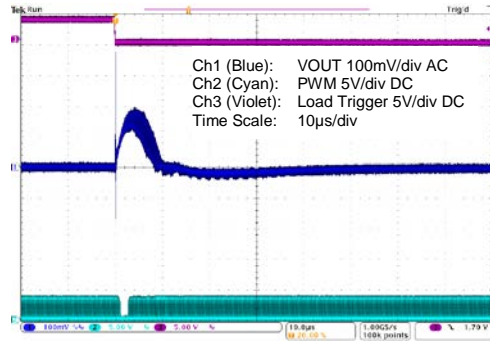

Figure 5.63 ZSPM1504 with Comp0; 5A to 15A Load Step; and Max. Capacitance

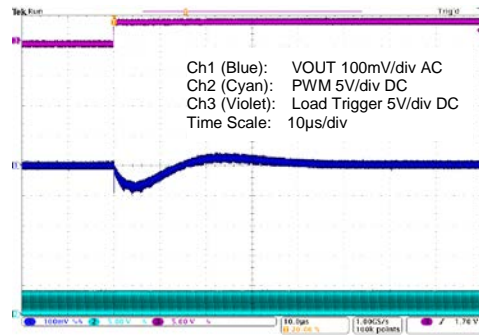

Figure 5.64 ZSPM1504 with Comp0; 15A to 5A Load Step; and Max. Capacitance

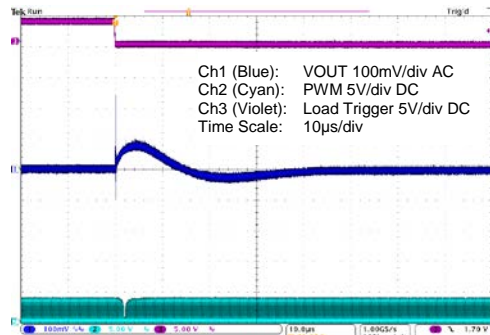
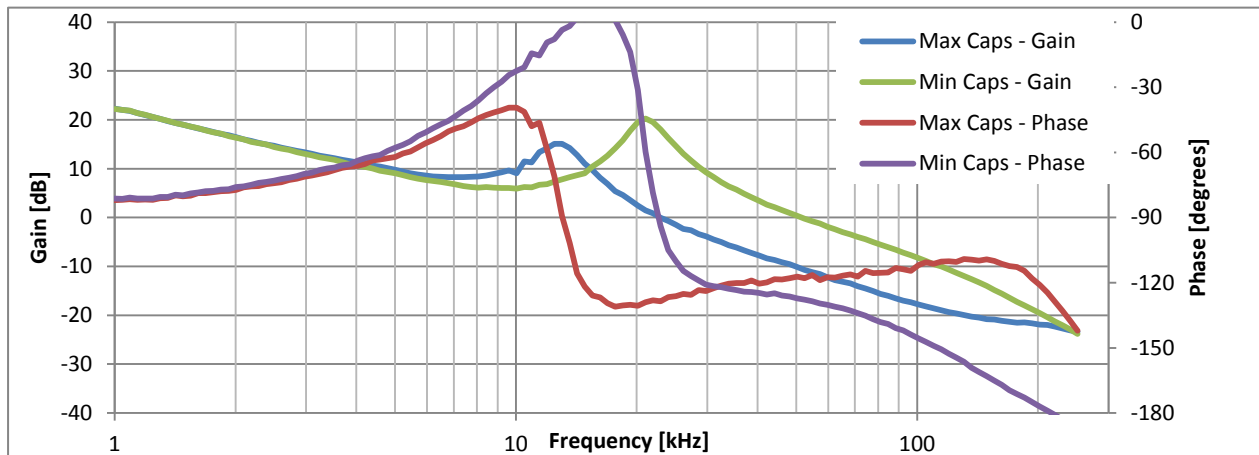

Figure 5.65 Open Loop Bode Plots for ZSPM1504 with Comp0



5.14. ZSPM1504 – Typical Load Transient Response – Capacitor Range #2 – Comp1

Test conditions: $V_{IN} = 12.0V$, $V_{OUT} = 1.50V$

Minimum output capacitance: $5 \times 100\mu F/6.3V \text{ X5R}$

Maximum output capacitance: $8 \times 100\mu F/6.3V \text{ X5R} + 4 \times 47\mu F/10V \text{ X7R}$

Figure 5.66 ZSPM1504 with Comp1; 5A to 15A Load Step; and Min. Capacitance

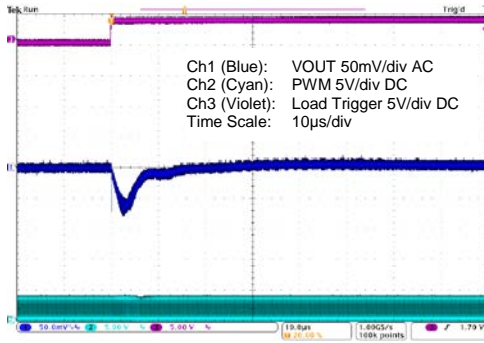

Figure 5.67 ZSPM1504 with Comp1; 15A to 5A Load Step; and Min. Capacitance

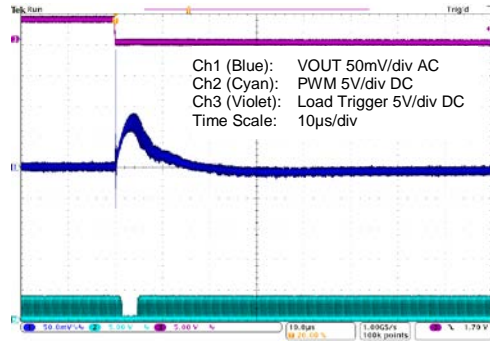

Figure 5.68 ZSPM1504 with Comp1; 5A to 15A Load Step; and Max. Capacitance

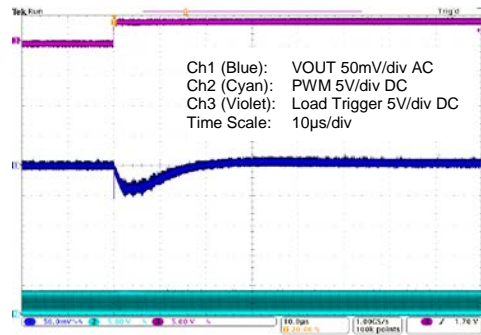

Figure 5.69 ZSPM1504 with Comp1; 15A to 5A Load Step; and Max. Capacitance

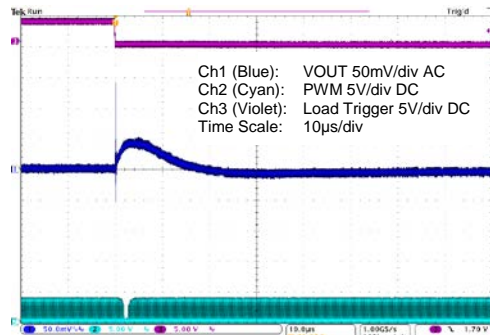
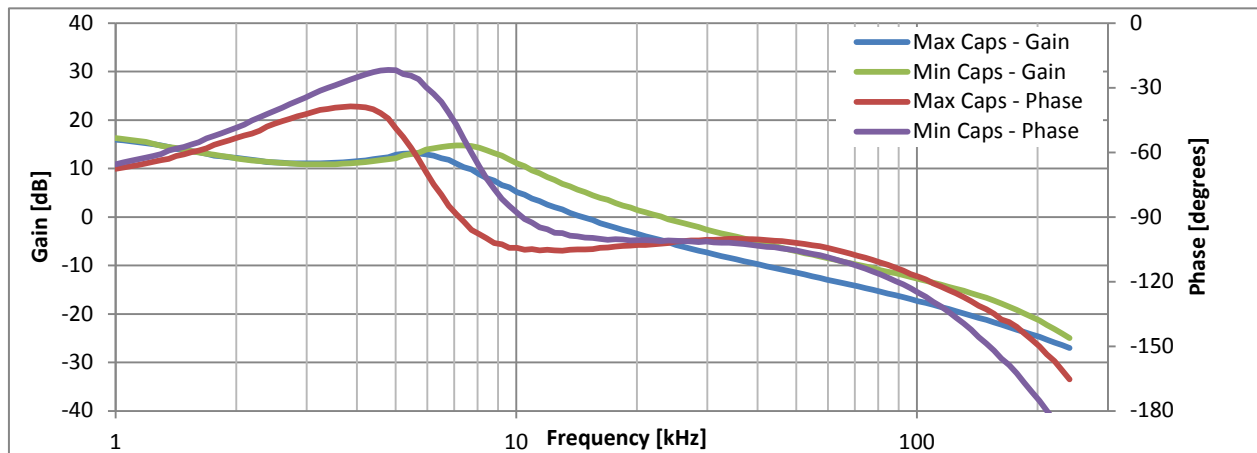

Figure 5.70 Open Loop Bode Plots for ZSPM1504 with Comp1



5.15. ZSPM1504 – Typical Load Transient Response – Capacitor Range #3 – Comp2

Test conditions: $V_{IN} = 12.0V$, $V_{OUT} = 1.50V$

Minimum output capacitance: $2 \times 100\mu F/6.3V \text{ X5R} + 2 \times 470\mu F/7m\Omega$

Maximum output capacitance: $4 \times 100\mu F/6.3V \text{ X5R} + 2 \times 47\mu F/10V \text{ X7R} + 4 \times 470\mu F/7m\Omega$

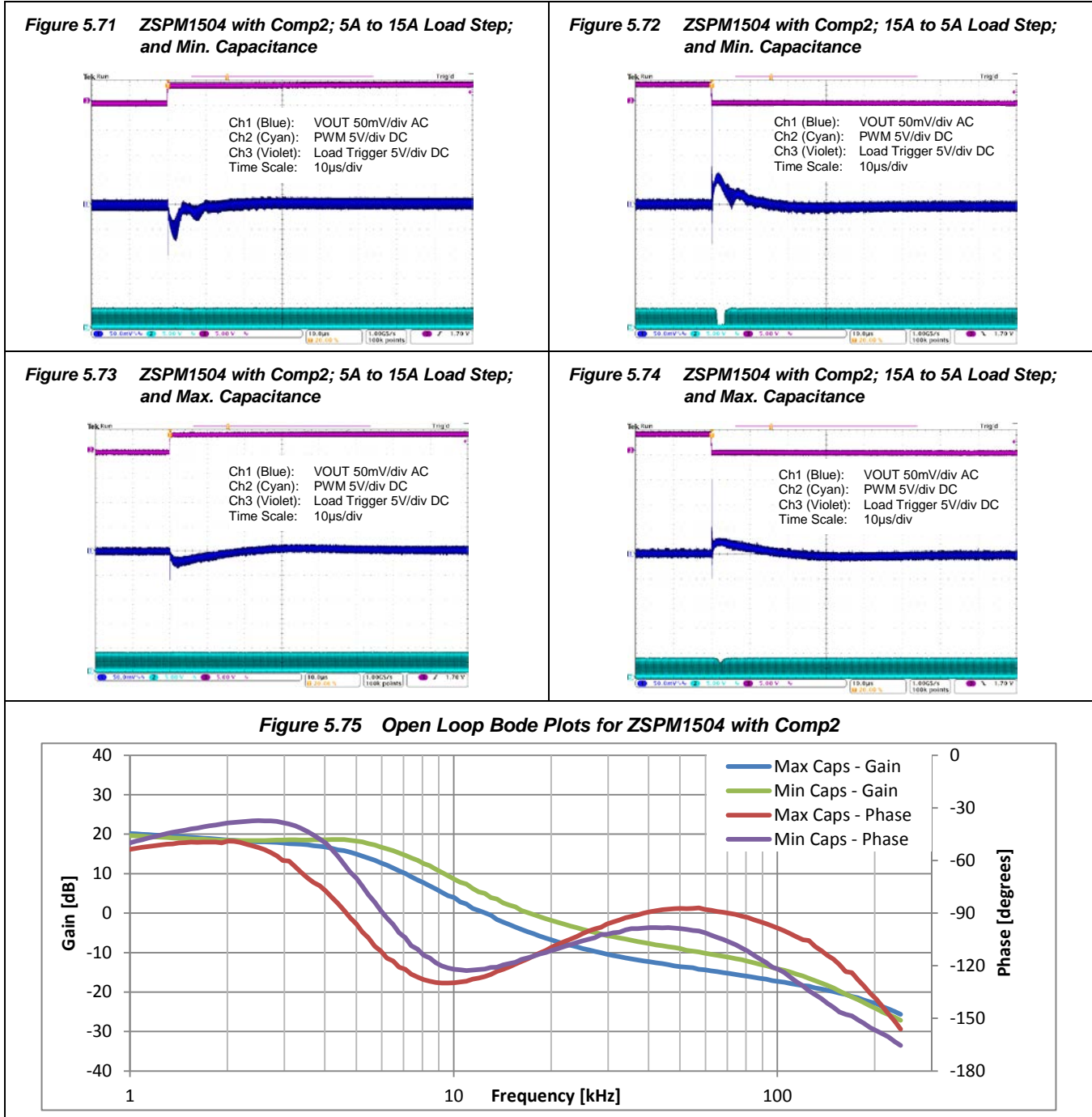

5.16. ZSPM1504 – Typical Load Transient Response – Capacitor Range #4 – Comp3

Test conditions: $V_{IN} = 12.0V$, $V_{OUT} = 1.50V$

Minimum output capacitance: $5 \times 100\mu F/6.3V \text{ X5R} + 4 \times 470\mu F/7m\Omega$

Maximum output capacitance: $8 \times 100\mu F/6.3V \text{ X5R} + 4 \times 47\mu F/10V \text{ X7R} + 6 \times 470\mu F/7m\Omega$

Figure 5.76 ZSPM1504 with Comp3; 5A to 15A Load Step; and Min. Capacitance

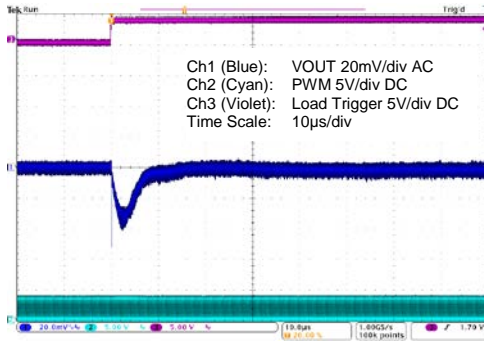

Figure 5.77 ZSPM1504 with Comp3; 15A to 5A Load Step; and Min. Capacitance

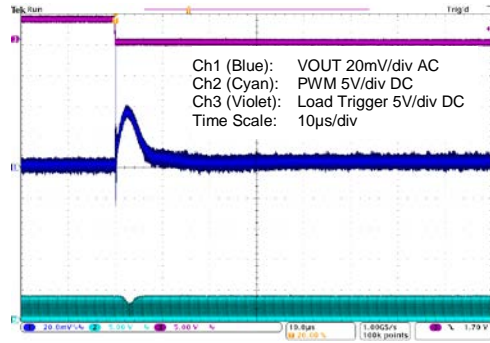

Figure 5.78 ZSPM1504 with Comp3; 5A to 15A Load Step; and Max. Capacitance

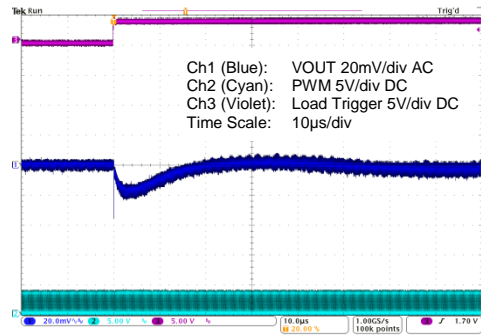

Figure 5.79 ZSPM1504 with Comp3; 15A to 5A Load Step; and Max. Capacitance

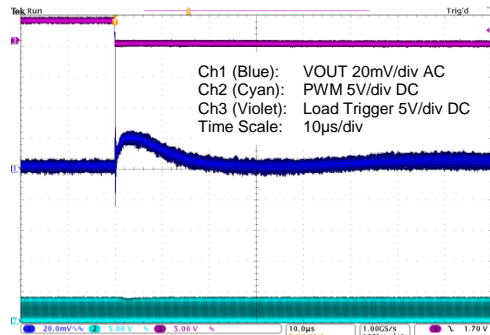
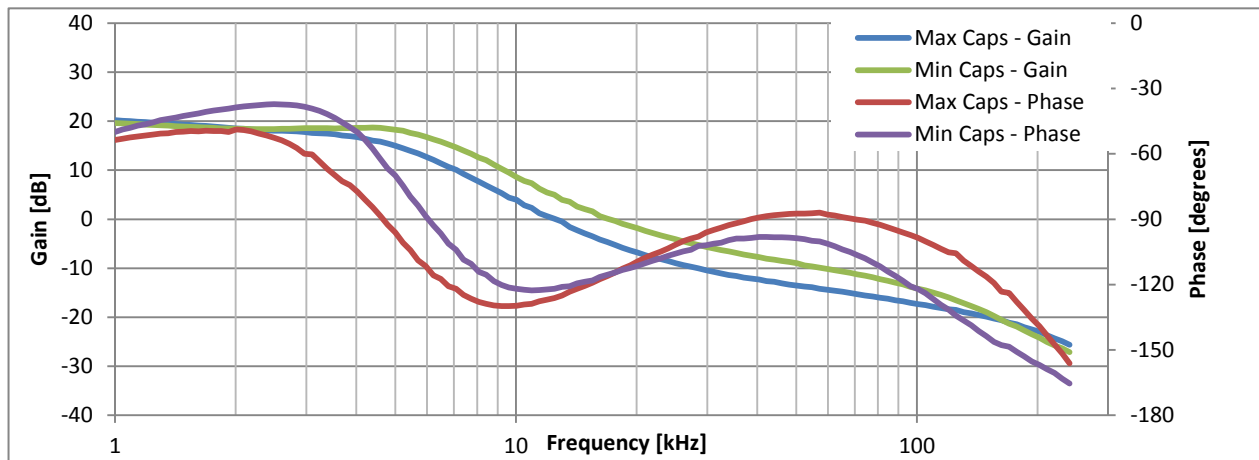

Figure 5.80 Open Loop Bode Plots for ZSPM1504 with Comp3



5.17. ZSPM1505 – Typical Load Transient Response – Capacitor Range #1 – Comp0

Test conditions: $V_{IN} = 12.0V$, $V_{OUT} = 1.80V$

Minimum output capacitance: $2 \times 100\mu F/6.3V \text{ X5R}$

Maximum output capacitance: $4 \times 100\mu F/6.3V \text{ X5R} + 2 \times 47\mu F/10V \text{ X7R}$

Figure 5.81 ZSPM1505 with Comp0; 5A to 15A Load Step; and Min. Capacitance

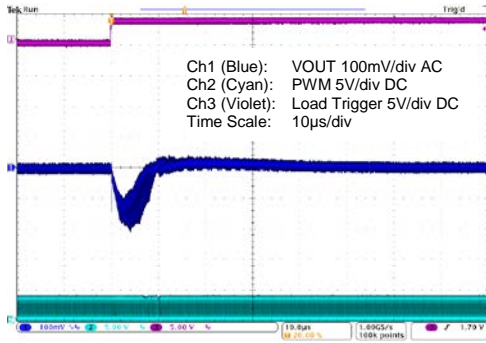

Figure 5.82 ZSPM1505 with Comp0; 15A to 5A Load Step; and Min. Capacitance

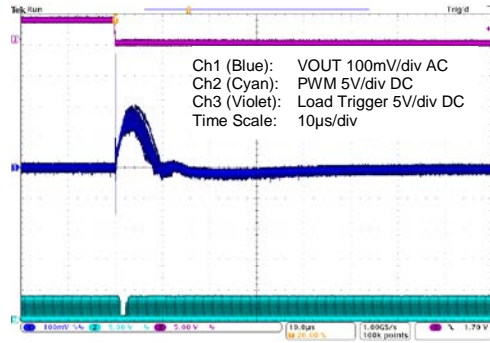

Figure 5.83 ZSPM1505 with Comp0; 5A to 15A Load Step; and Max. Capacitance

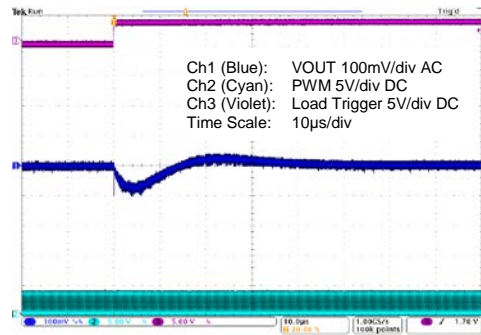

Figure 5.84 ZSPM1505 with Comp0; 15A to 5A Load Step; and Max. Capacitance

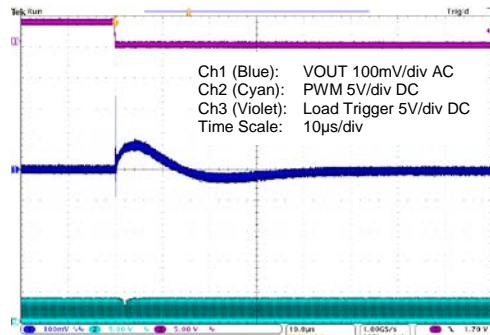
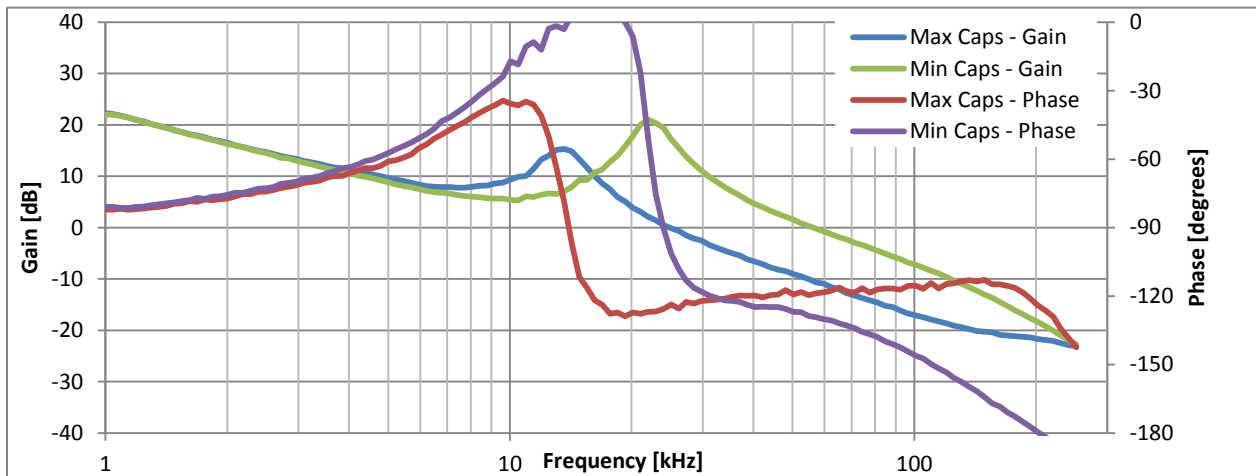

Figure 5.85 Open Loop Bode Plots for ZSPM1505 with Comp0



5.18. ZSPM1505 – Typical Load Transient Response – Capacitor Range #2 – Comp1

Test conditions: $V_{IN} = 12.0V$, $V_{OUT} = 1.80V$
 Minimum output capacitance: $5 \times 100\mu F/6.3V \text{ X5R}$
 Maximum output capacitance: $8 \times 100\mu F/6.3V \text{ X5R} + 4 \times 47\mu F/10V \text{ X7R}$

Figure 5.86 ZSPM1505 with Comp1; 5A to 15A Load Step; and Min. Capacitance

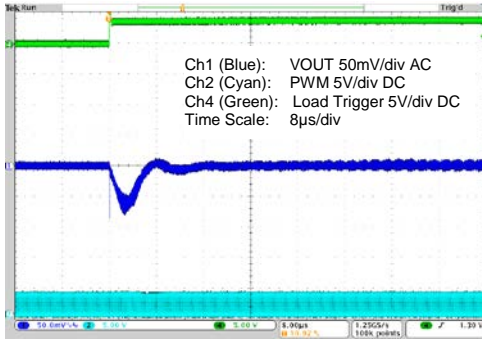

Figure 5.87 ZSPM1505 with Comp1; 15A to 5A Load Step; and Min. Capacitance

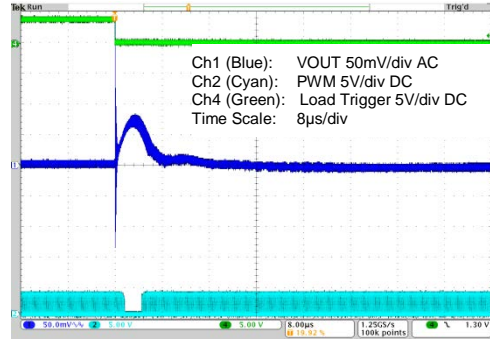

Figure 5.88 ZSPM1505 with Comp1; 5A to 15A Load Step; and Max. Capacitance

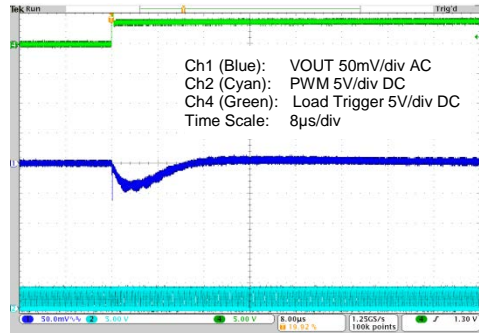

Figure 5.89 ZSPM1505 with Comp1; 15A to 5A Load Step; and Max. Capacitance

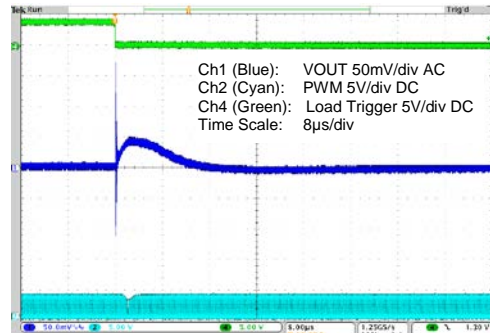
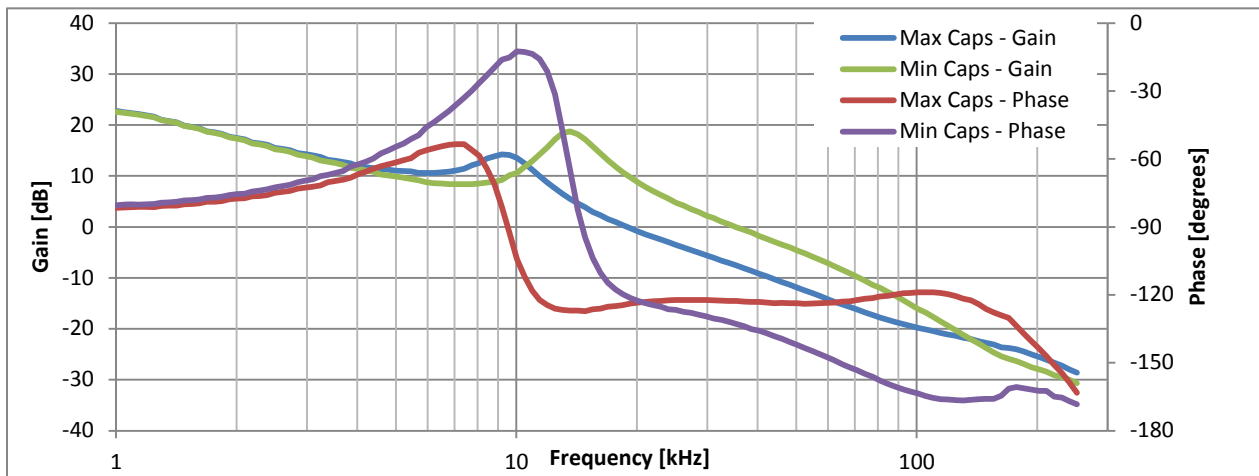

Figure 5.90 Open Loop Bode Plots for ZSPM1505 with Comp1



5.19. ZSPM1505 – Typical Load Transient Response – Capacitor Range #3 – Comp2

Test conditions: $V_{IN} = 12.0V$, $V_{OUT} = 1.80V$

Minimum output capacitance: $2 \times 100\mu F/6.3V \text{ X5R} + 2 \times 470\mu F/7m\Omega$

Maximum output capacitance: $4 \times 100\mu F/6.3V \text{ X5R} + 2 \times 47\mu F/10V \text{ X7R} + 4 \times 470\mu F/7m\Omega$

Figure 5.91 ZSPM1505 with Comp2; 5A to 15A Load Step; and Min. Capacitance

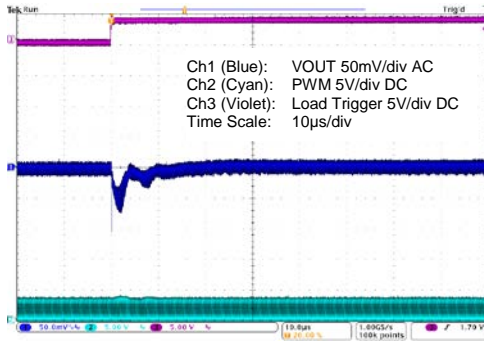

Figure 5.92 ZSPM1505 with Comp2; 15A to 5A Load Step; and Min. Capacitance

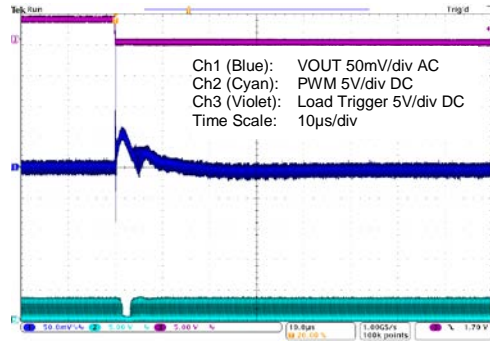

Figure 5.93 ZSPM1505 with Comp2; 5A to 15A Load Step; and Max. Capacitance

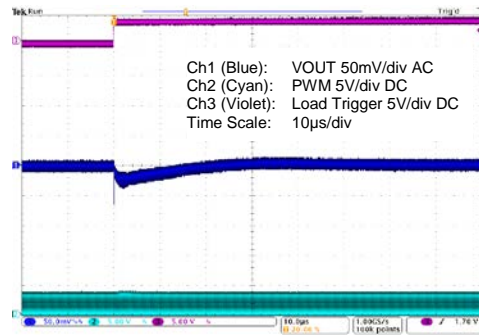

Figure 5.94 ZSPM1505 with Comp2; 15A to 5A Load Step; and Max. Capacitance

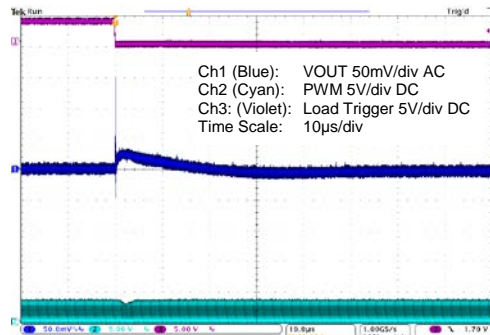
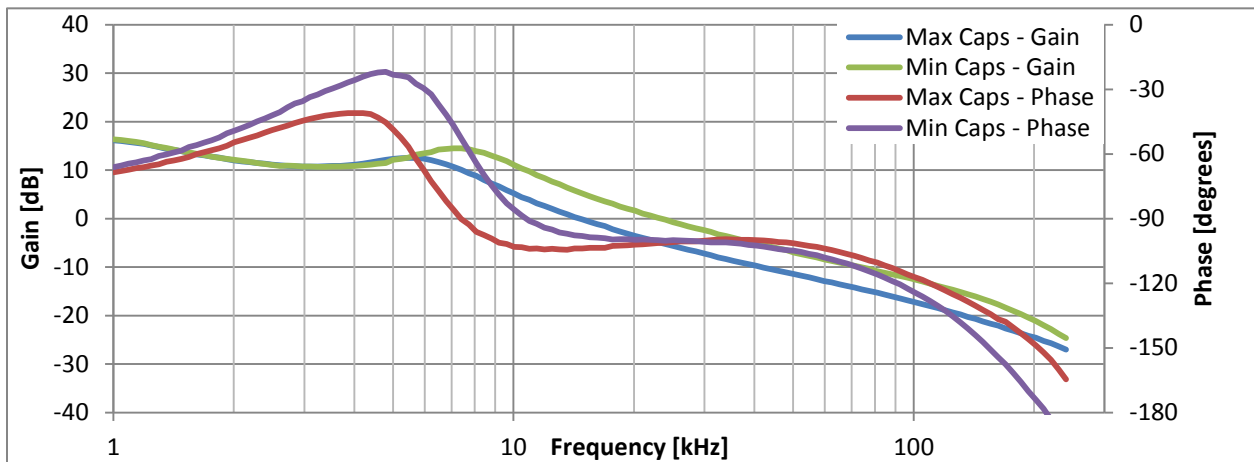

Figure 5.95 Open Loop Bode Plots for ZSPM1505 with Comp2



5.20. ZSPM1505 – Typical Load Transient Response – Capacitor Range #4 – Comp3

Test conditions: $V_{IN} = 12.0V$, $V_{OUT} = 1.80V$

Minimum output capacitance: $5 \times 100\mu F/6.3V \text{ X5R} + 4 \times 470\mu F/7m\Omega$

Maximum output capacitance: $8 \times 100\mu F/6.3V \text{ X5R} + 4 \times 47\mu F/10V \text{ X7R} + 6 \times 470\mu F/7m\Omega$

Figure 5.96 ZSPM1505 with Comp3; 5A to 15A Load Step; and Min. Capacitance

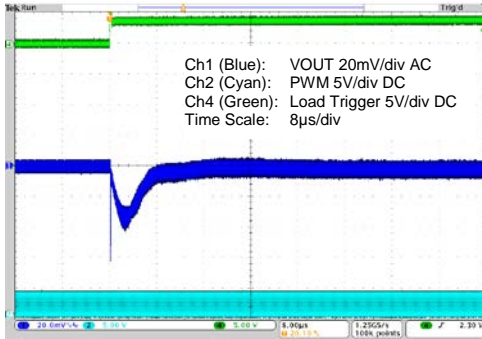

Figure 5.97 ZSPM1505 with Comp3; 15A to 5A Load Step; and Min. Capacitance

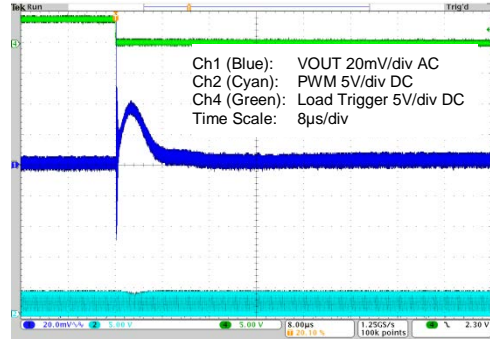

Figure 5.98 ZSPM1505 with Comp3; 5A to 15A Load Step; and Max. Capacitance

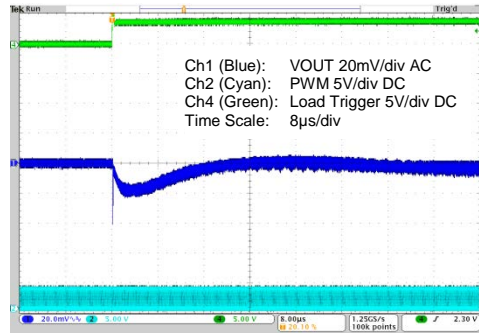

Figure 5.99 ZSPM1505 with Comp3; 15A to 5A Load Step; and Max. Capacitance

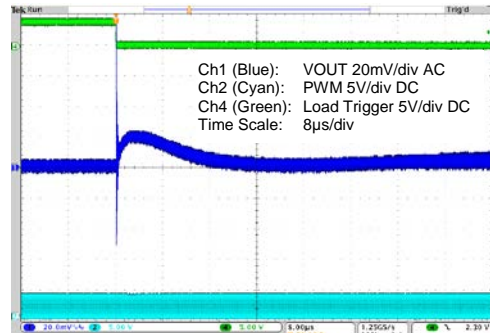
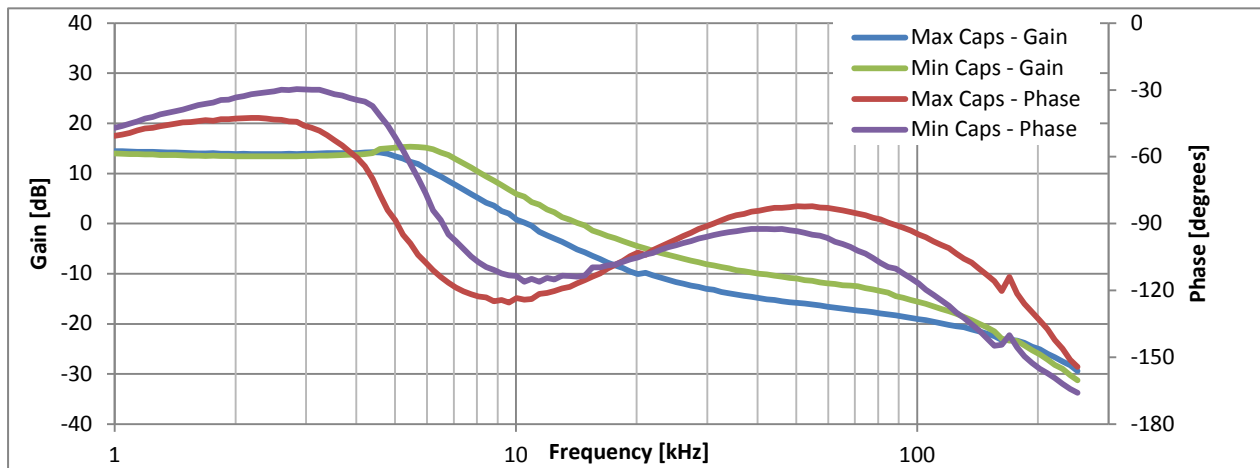

Figure 5.100 Open Loop Bode Plots for ZSPM1505 with Comp3



5.21. ZSPM1506 – Typical Load Transient Response – Capacitor Range #1 – Comp0

Test conditions: $V_{IN} = 12.0V$, $V_{OUT} = 2.00V$

Minimum output capacitance: $2 \times 100\mu F/6.3V \text{ X5R}$

Maximum output capacitance: $4 \times 100\mu F/6.3V \text{ X5R} + 2 \times 47\mu F/10V \text{ X7R}$

Figure 5.101 ZSPM1506 with Comp0; 5A to 15A Load Step; and Min. Capacitance

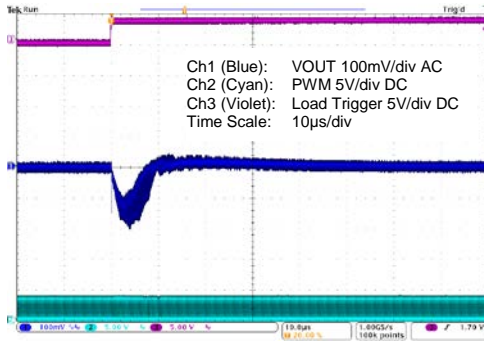

Figure 5.102 ZSPM1506 with Comp0; 15A to 5A Load Step; and Min. Capacitance

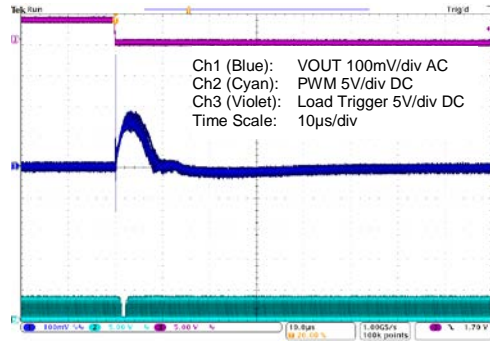

Figure 5.103 ZSPM1506 with Comp0; 5A to 15A Load Step; and Max. Capacitance

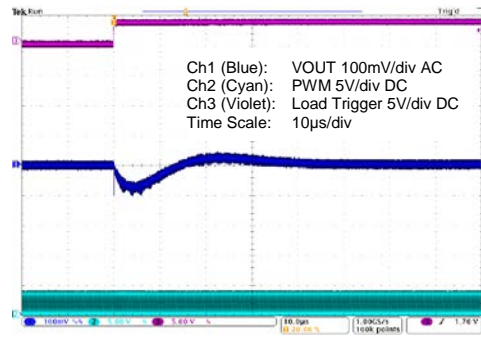

Figure 5.104 ZSPM1506 with Comp0; 15A to 5A Load Step; and Max. Capacitance

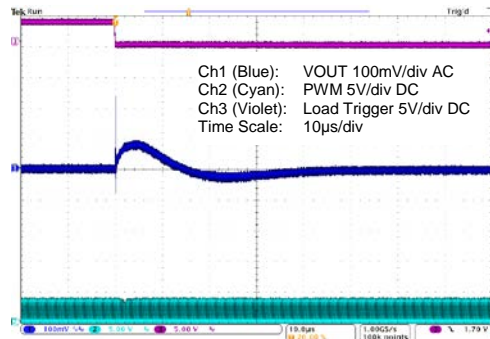
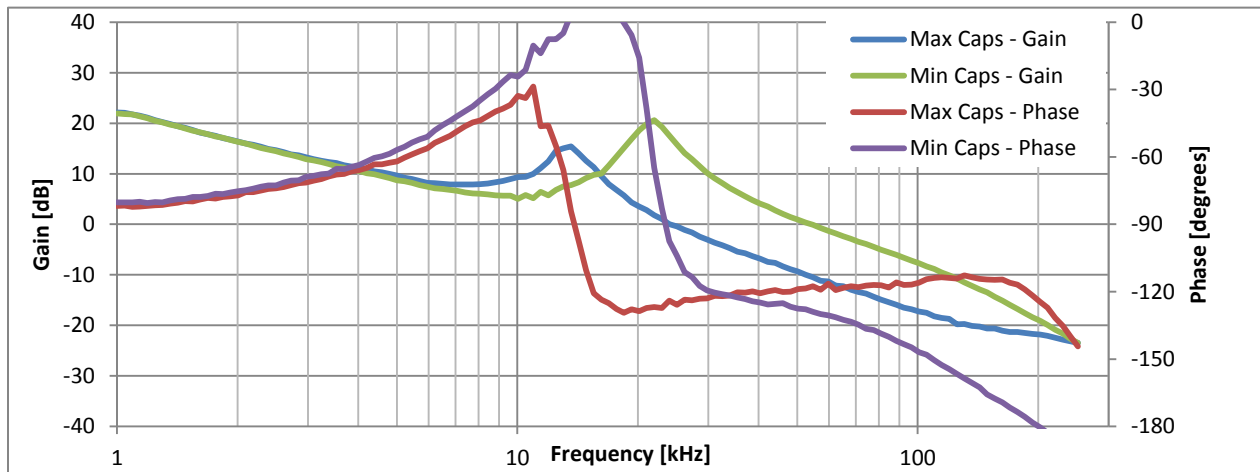

Figure 5.105 Open Loop Bode Plots for ZSPM1506 with Comp0



5.22. ZSPM1506 – Typical Load Transient Response – Capacitor Range #2 – Comp1

Test conditions: $V_{IN} = 12.0V$, $V_{OUT} = 2.00V$

Minimum output capacitance: $5 \times 100\mu F/6.3V \text{ X5R}$

Maximum output capacitance: $8 \times 100\mu F/6.3V \text{ X5R} + 4 \times 47\mu F/10V \text{ X7R}$

Figure 5.106 ZSPM1506 with Comp1; 5A to 15A Load Step; and Min. Capacitance

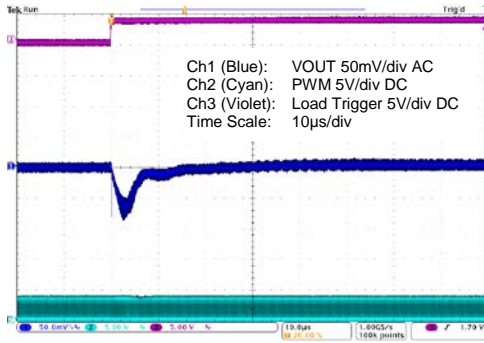

Figure 5.107 ZSPM1506 with Comp1; 15A to 5A Load Step; and Min. Capacitance

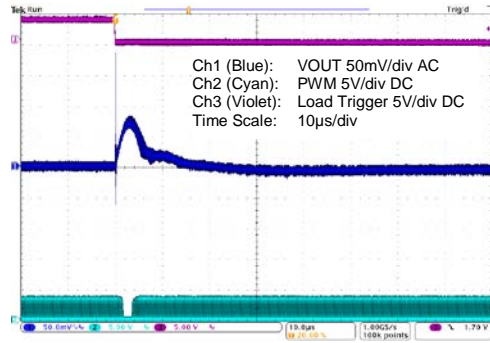

Figure 5.108 ZSPM1506 with Comp1; 5A to 15A Load Step; and Max. Capacitance

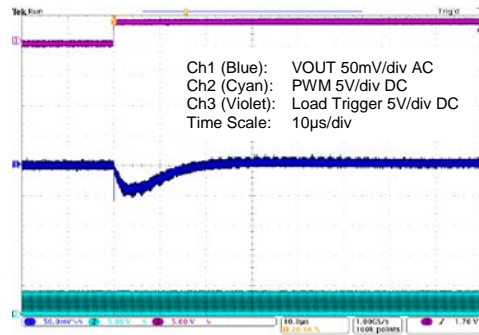

Figure 5.109 ZSPM1506 with Comp1; 15A to 5A Load Step; and Max. Capacitance

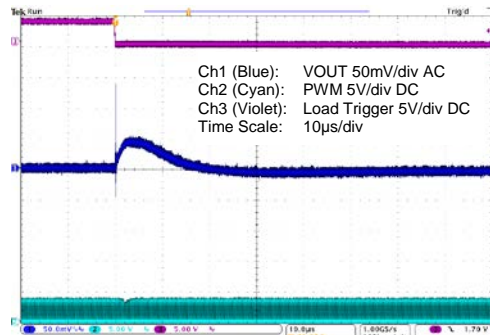
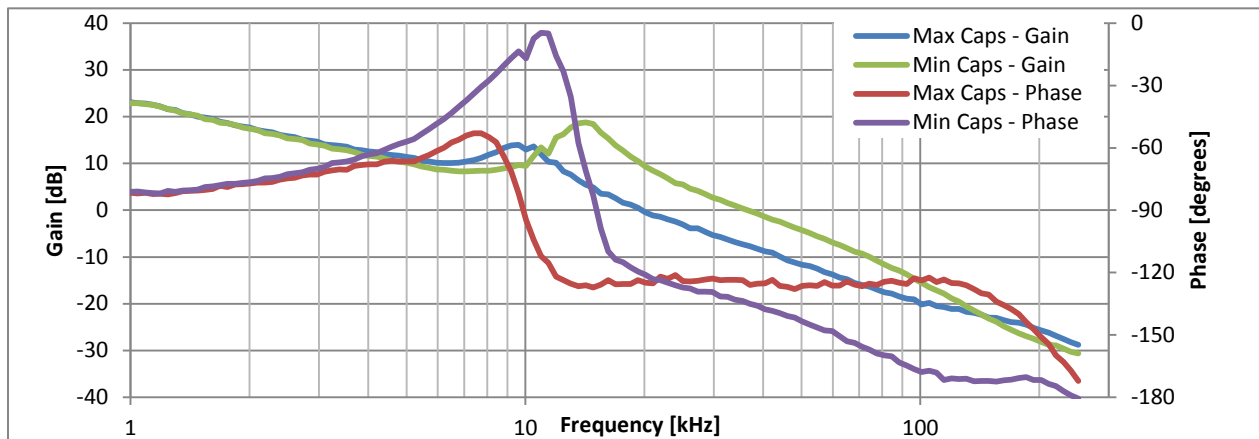

Figure 5.110 Open Loop Bode Plots for ZSPM1506 with Comp1



5.23. ZSPM1506 – Typical Load Transient Response – Capacitor Range #3 – Comp2

Test conditions: $V_{IN} = 12.0V$, $V_{OUT} = 2.00V$

Minimum output capacitance: $2 \times 100\mu F/6.3V \text{ X5R} + 2 \times 470\mu F/7m\Omega$

Maximum output capacitance: $4 \times 100\mu F/6.3V \text{ X5R} + 2 \times 47\mu F/10V \text{ X7R} + 4 \times 470\mu F/7m\Omega$

Figure 5.111 ZSPM1506 with Comp2; 5A to 15A Load Step; and Min. Capacitance

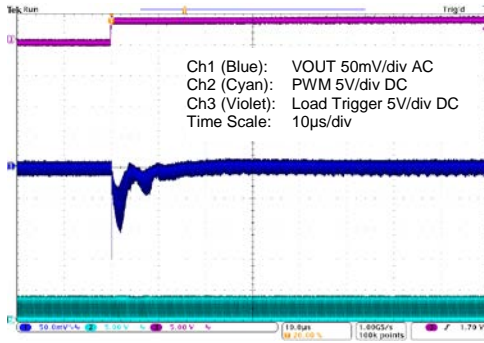

Figure 5.112 ZSPM1506 with Comp2; 15A to 5A Load Step; and Min. Capacitance

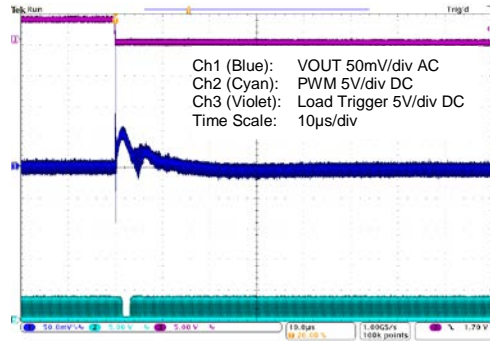

Figure 5.113 ZSPM1506 with Comp2; 5A to 15A Load Step; and Max. Capacitance

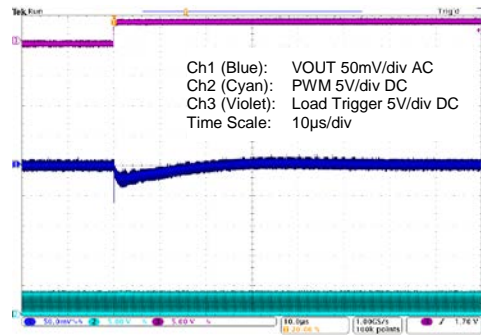

Figure 5.114 ZSPM1506 with Comp2; 15A to 5A Load Step; and Max. Capacitance

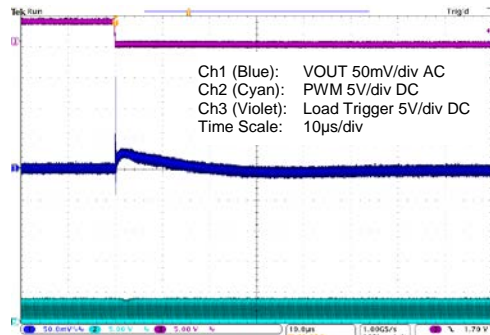
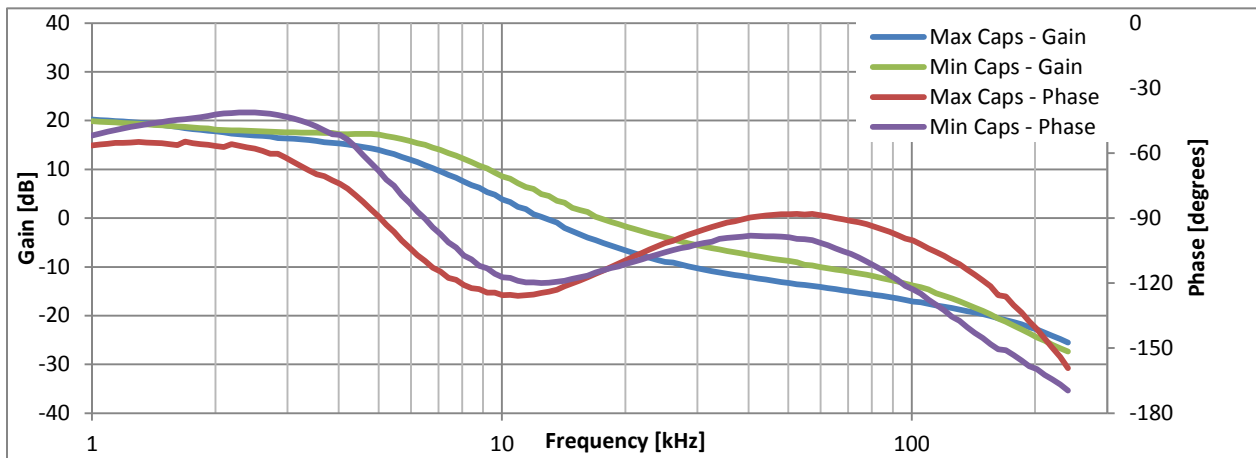

Figure 5.115 Open Loop Bode Plots for ZSPM1506 with Comp2



5.24. ZSPM1506 – Typical Load Transient Response – Capacitor Range #4 – Comp3

Test conditions: $V_{IN} = 12.0V$, $V_{OUT} = 2.00V$

Minimum output capacitance: $5 \times 100\mu F/6.3V \text{ X5R} + 4 \times 470\mu F/7m\Omega$

Maximum output capacitance: $8 \times 100\mu F/6.3V \text{ X5R} + 4 \times 47\mu F/10V \text{ X7R} + 6 \times 470\mu F/7m\Omega$

Figure 5.116 ZSPM1506 with Comp3; 5A to 15A Load Step; and Min. Capacitance

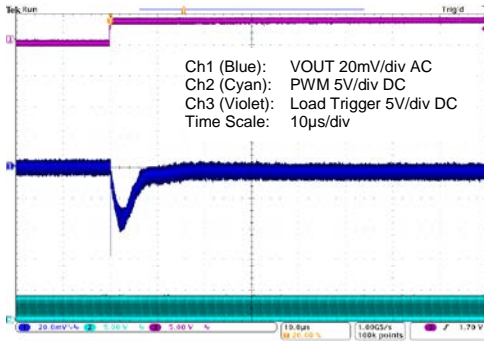

Figure 5.117 ZSPM1506 with Comp3; 15A to 5A Load Step; and Min. Capacitance

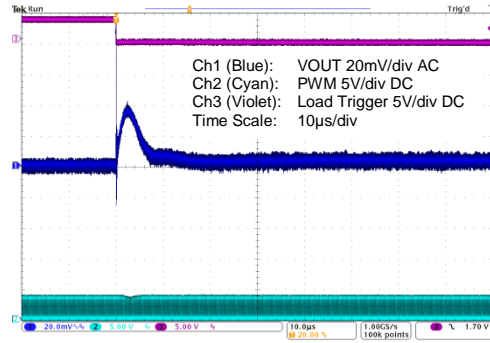

Figure 5.118 ZSPM1506 with Comp3; 5A to 15A Load Step; and Max. Capacitance

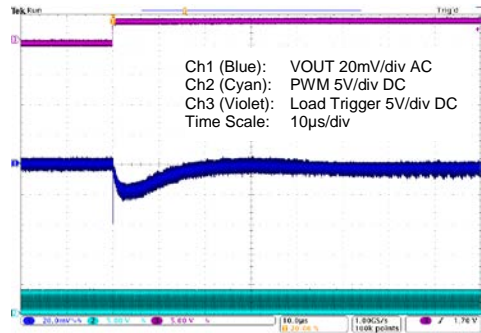

Figure 5.119 ZSPM1506 with Comp3; 15A to 5A Load Step; and Max. Capacitance

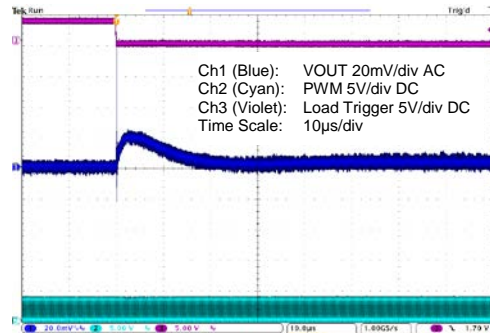
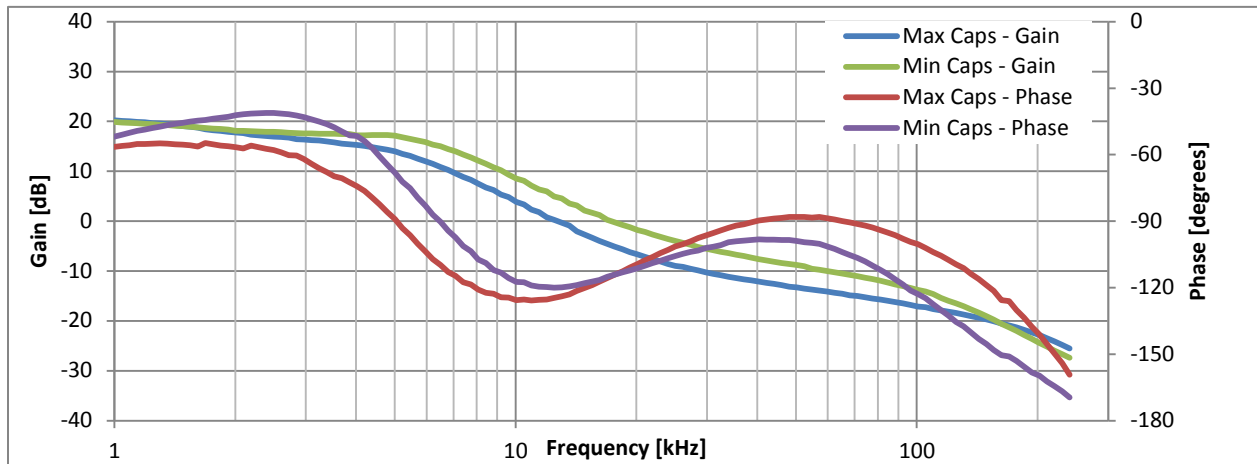

Figure 5.120 Open Loop Bode Plots for ZSPM1506 with Comp3



5.25. ZSPM1507 – Typical Load Transient Response –Capacitor Range 1 – Comp0

Test conditions: $V_{IN} = 12.0V$, $V_{OUT} = 2.50V$

Minimum output capacitance: $2 \times 100\mu F/6.3V \text{ X5R}$

Maximum output capacitance: $4 \times 100\mu F/6.3V \text{ X5R} + 2 \times 47\mu F/10V \text{ X7R}$

Figure 5.121 ZSPM1507 with Comp0; 5 to 15A Load Step; and Min. Capacitance

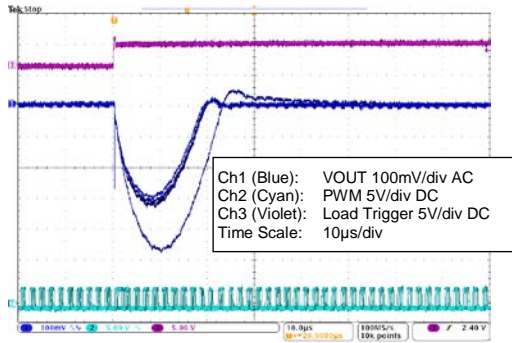

Figure 5.122 ZSPM1507 with Comp0; 15 to 5A Load Step; and Min. Capacitance

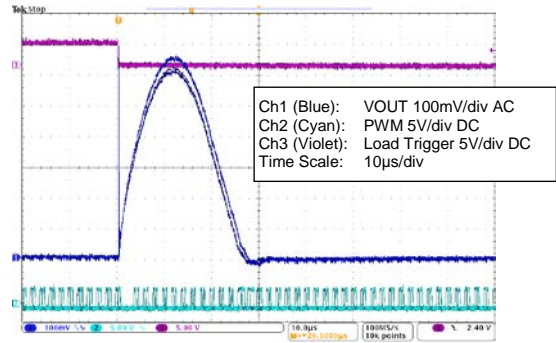

Figure 5.123 ZSPM1507 with Comp0; 5 to 15A Load Step; and Max. Capacitance

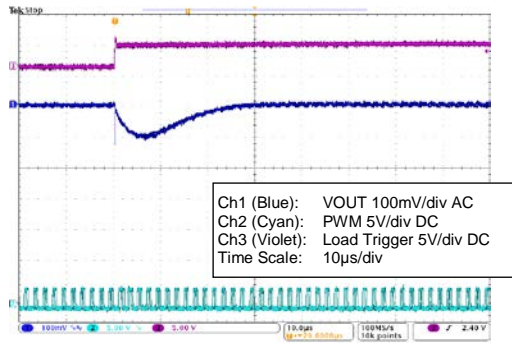

Figure 5.124 ZSPM1507 with Comp0; 15 to 5A Load Step; and Max. Capacitance

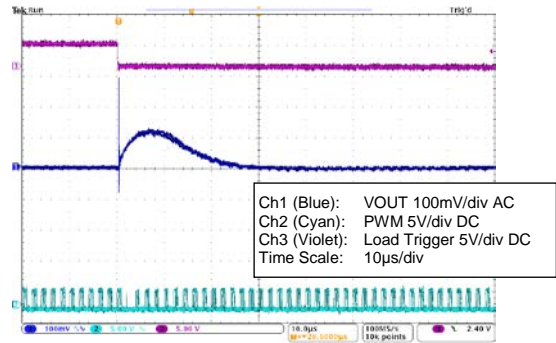
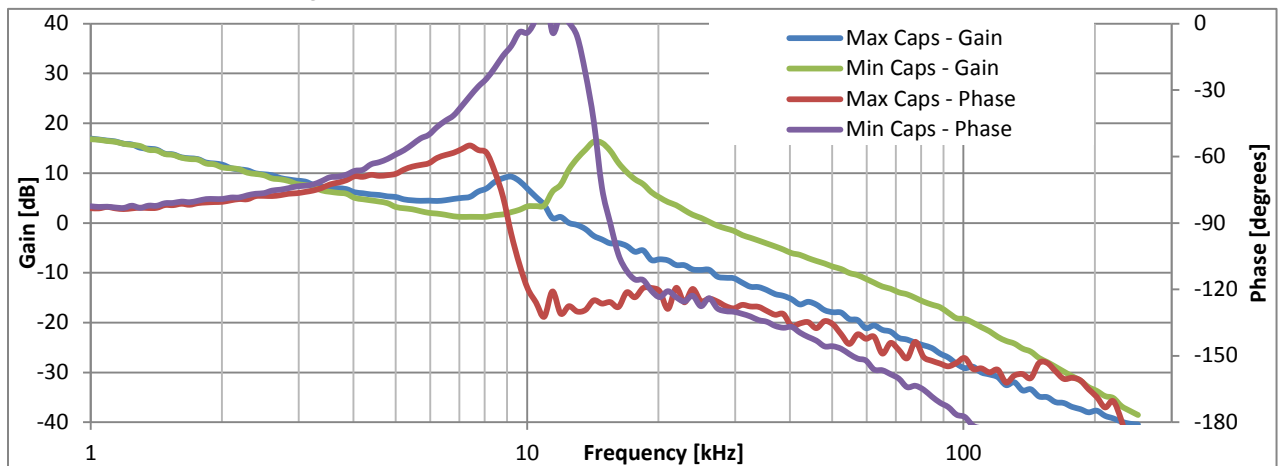

Figure 5.125 Open Loop Bode Plots for ZSPM1507 with Comp0



5.26. ZSPM1507 – Typical Load Transient Response –Capacitor Range 2 – Comp1

Test conditions: $V_{IN} = 12.0V$, $V_{OUT} = 2.50V$

Minimum output capacitance: $5 \times 100\mu F/6.3V \times 5R$

Maximum output capacitance: $8 \times 100\mu F/6.3V \times 5R + 4 \times 47\mu F/10V \times 7R$

Figure 5.126 ZSPM1507 with Comp1; 5 to 15A Load Step; and Min. Capacitance

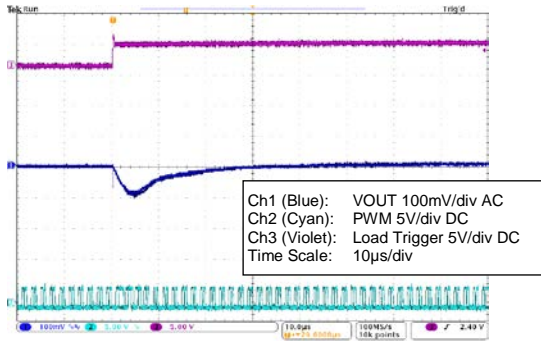

Figure 5.127 ZSPM1507 with Comp1; 15 to 5A Load Step; and Min. Capacitance

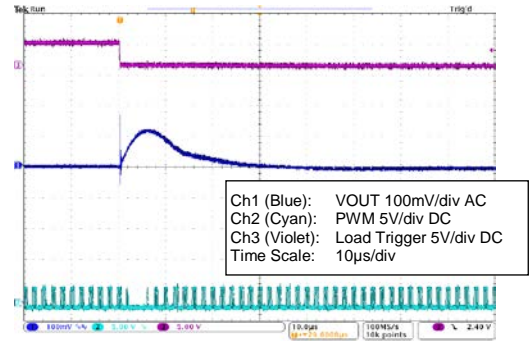

Figure 5.128 ZSPM1507 with Comp1; 5 to 15A Load Step; and Max. Capacitance

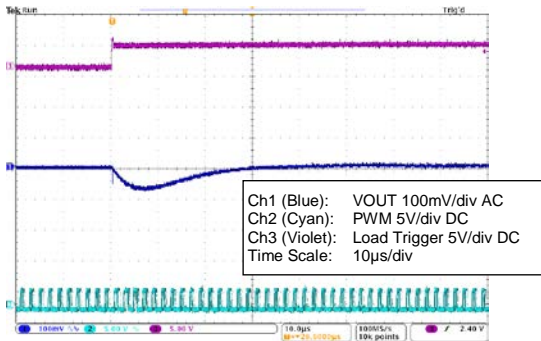

Figure 5.129 ZSPM1507 with Comp1; 15 to 5A Load Step; and Max. Capacitance

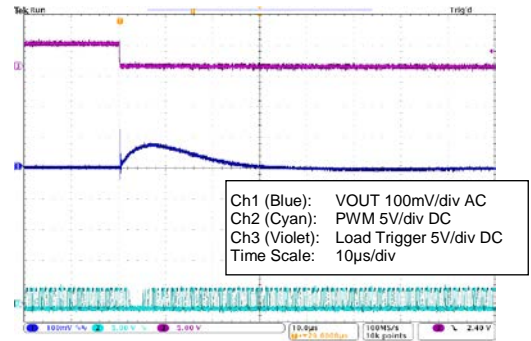
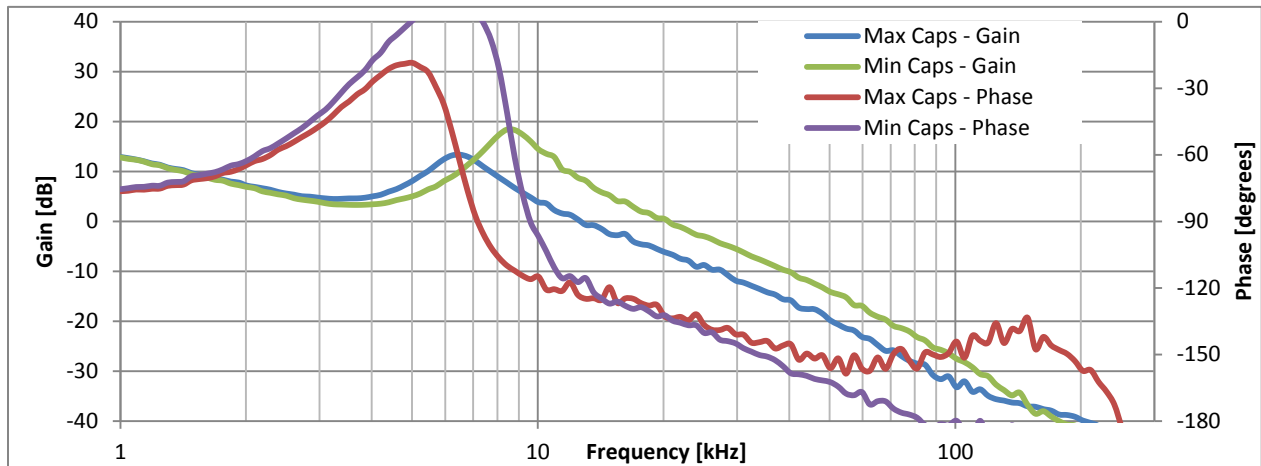

Figure 5.130 Open Loop Bode Plots for ZSPM1507 with Comp1



5.27. ZSPM1507 – Typical Load Transient Response –Capacitor Range 3 – Comp2

Test conditions: $V_{IN} = 12.0V$, $V_{OUT} = 2.50V$

Minimum output capacitance: $2 \times 100\mu F/6.3V \text{ X5R} + 2 \times 470\mu F/7m\Omega$

Maximum output capacitance: $4 \times 100\mu F/6.3V \text{ X5R} + 2 \times 47\mu F/10V \text{ X7R} + 4 \times 470\mu F/7m\Omega$

Figure 5.131 ZSPM1507 with Comp2; 5 to 15A Load Step; and Min. Capacitance

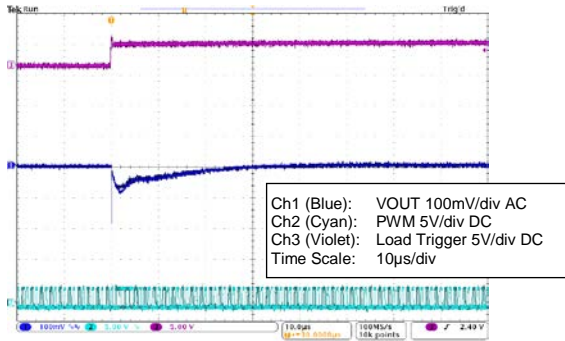

Figure 5.132 ZSPM1507 with Comp2; 15 to 5A Load Step; and Min. Capacitance

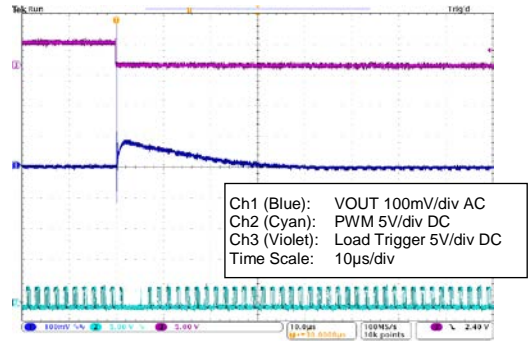

Figure 5.133 ZSPM1507 with Comp2; 5 to 15A Load Step; and Max. Capacitance

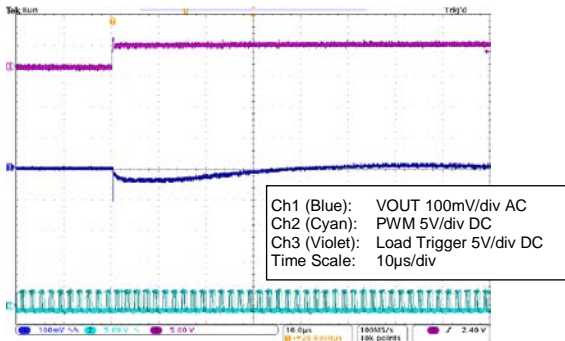

Figure 5.134 ZSPM1507 with Comp2; 15 to 5A Load Step; and Max. Capacitance

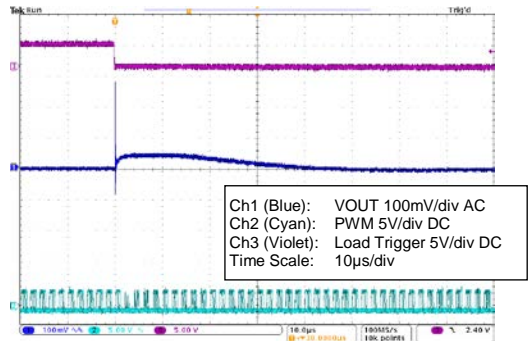
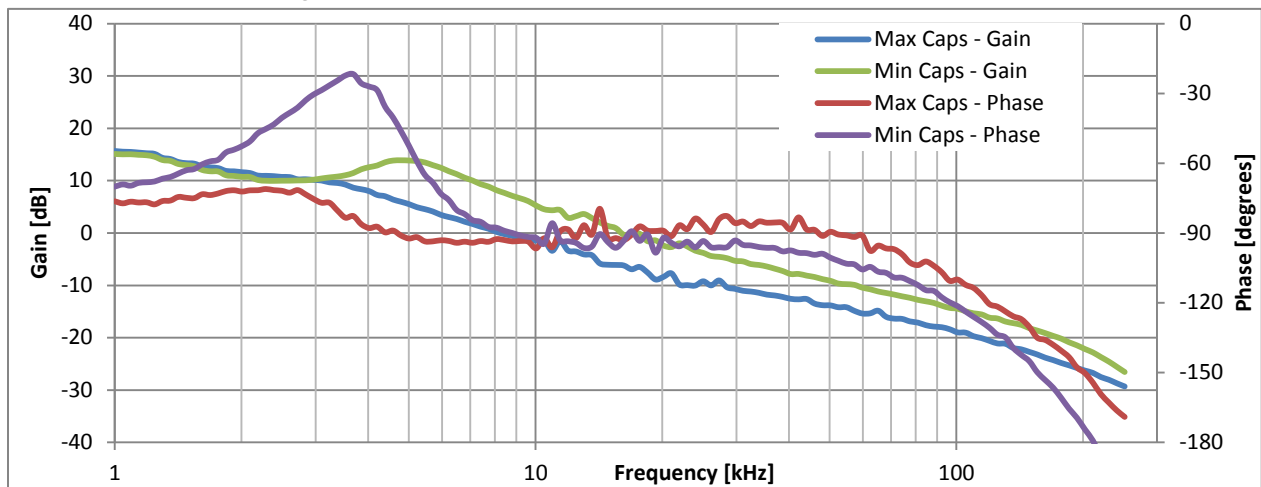

Figure 5.135 Open Loop Bode Plots for ZSPM1507 with Comp2



5.28. ZSPM1507 – Typical Load Transient Response –Capacitor Range 4 – Comp3

Test conditions: $V_{IN} = 12.0V$, $V_{OUT} = 2.50V$

Minimum output capacitance: $5 \times 100\mu F/6.3V \text{ X5R} + 4 \times 470\mu F/7m\Omega$

Maximum output capacitance: $8 \times 100\mu F/6.3V \text{ X5R} + 4 \times 47\mu F/10V \text{ X7R} + 6 \times 470\mu F/7m\Omega$

Figure 5.136 ZSPM1507 with Comp3; 5 to 15A Load Step; and Min. Capacitance

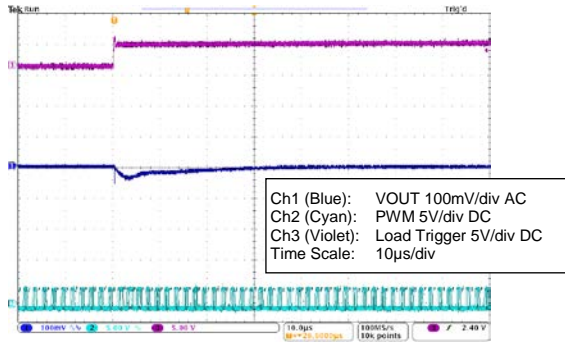

Figure 5.137 ZSPM1507 with Comp3; 15 to 5A Load Step; and Min. Capacitance

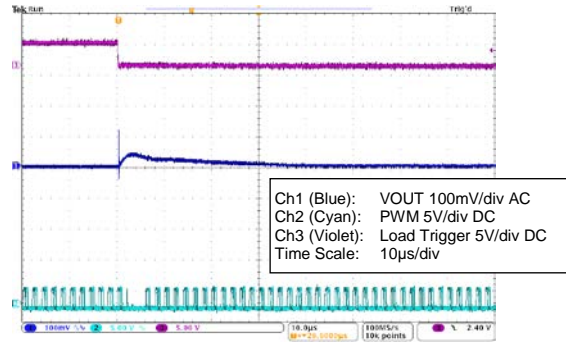

Figure 5.138 ZSPM1507 with Comp3; 5 to 15A Load Step; and Max. Capacitance

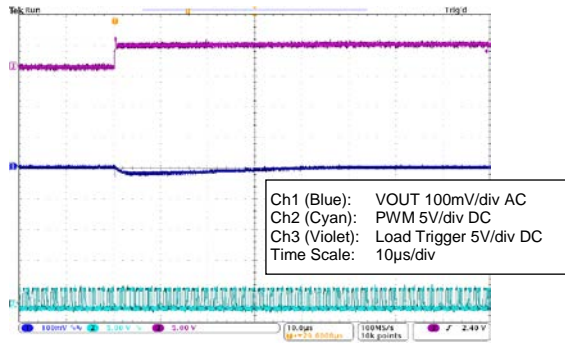

Figure 5.139 ZSPM1507 with Comp3; 15 to 5A Load Step; and Max. Capacitance

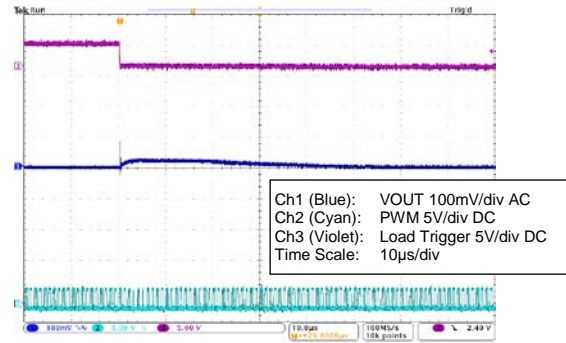
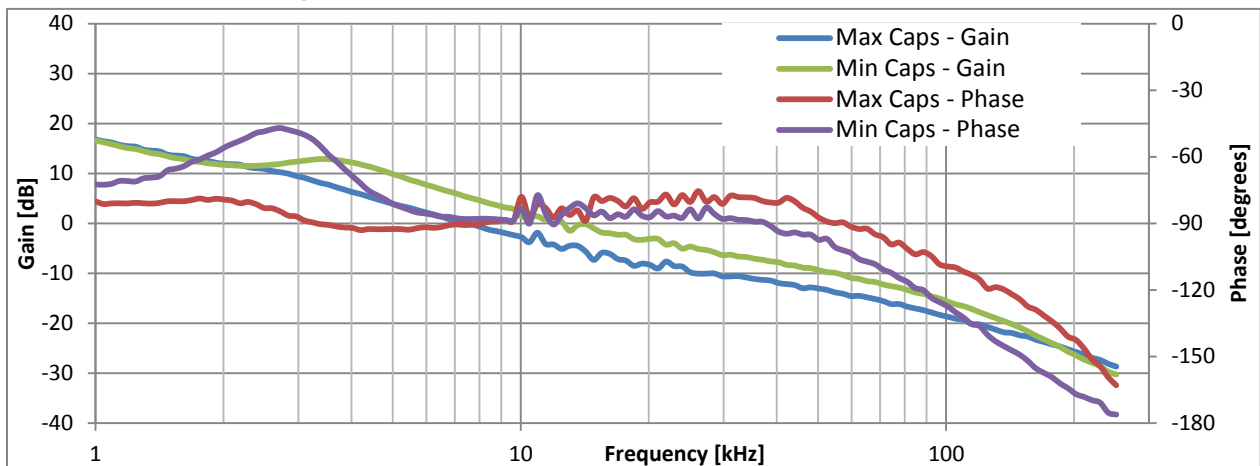

Figure 5.140 Open Loop Bode Plots for ZSPM1507 with Comp3



5.29. ZSPM1508 – Typical Load Transient Response –Capacitor Range 1 – Comp0

Test conditions: $V_{IN} = 12.0V$, $V_{OUT} = 3.30V$

Minimum output capacitance: $2 \times 100\mu F/10V$ X5R

Maximum output capacitance: $4 \times 100\mu F/10V$ X5R + $2 \times 47\mu F/10V$ X7R

Figure 5.141 ZSPM1508 with Comp0; 5A to 10A Load Step; and Min. Capacitance

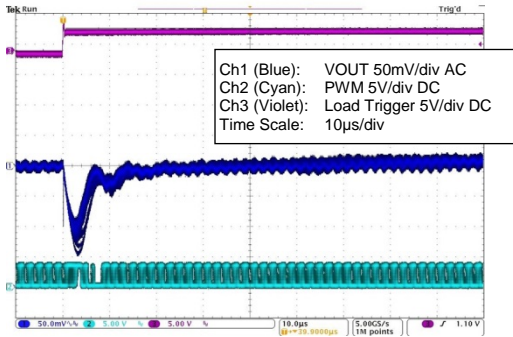

Figure 5.142 ZSPM1508 with Comp0; 10A to 5A Load Step; and Min. Capacitance

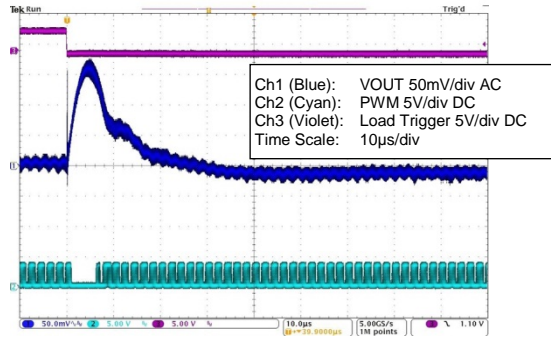

Figure 5.143 ZSPM1508 with Comp0; 5A to 10A Load Step; and Max. Capacitance

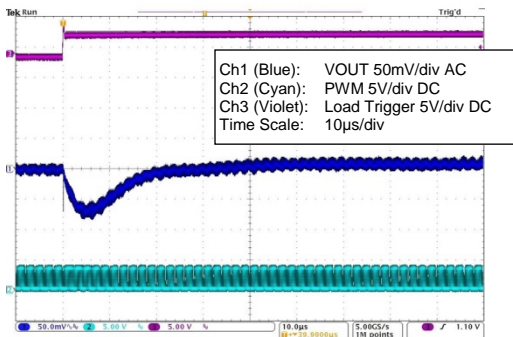

Figure 5.144 ZSPM1508 with Comp0; 10A to 5A Load Step; and Max. Capacitance

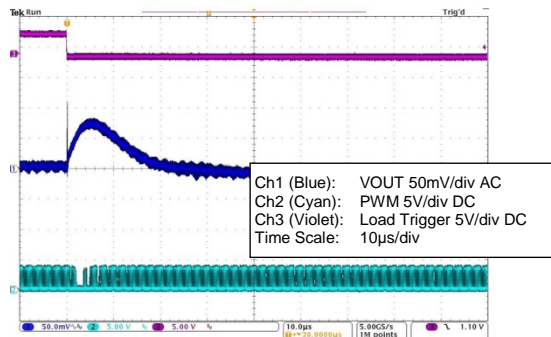
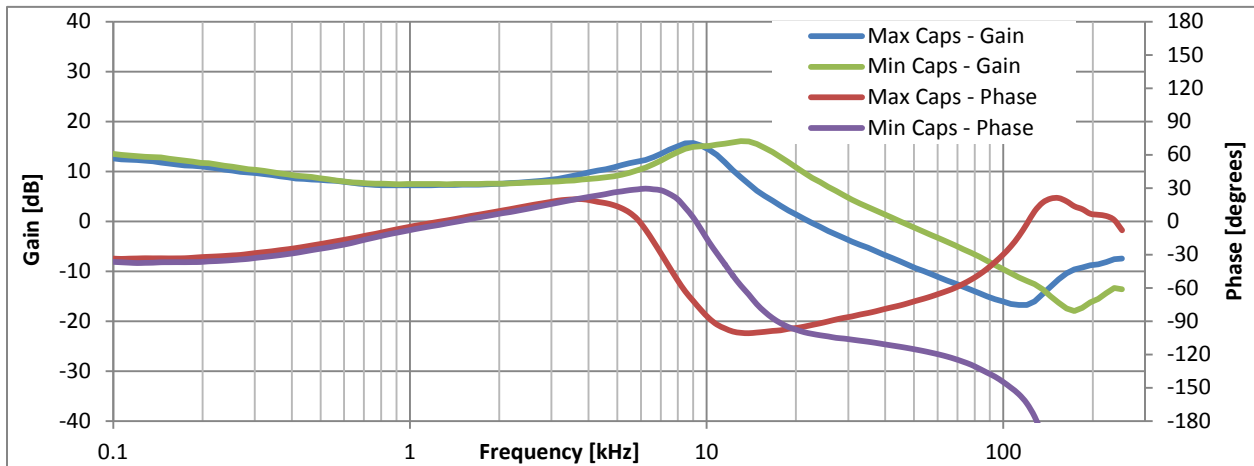

Figure 5.145 Open Loop Bode Plots for ZSPM1508 with Comp0



5.30. ZSPM1508 – Typical Load Transient Response –Capacitor Range 2 – Comp1

Test conditions: $V_{IN} = 12.0V$, $V_{OUT} = 3.30V$

Minimum output capacitance: $5 \times 100\mu F/10V \text{ X5R}$

Maximum output capacitance: $8 \times 100\mu F/10V \text{ X5R} + 4 \times 47\mu F/10V \text{ X7R}$

Figure 5.146 ZSPM1508 with Comp1; 5A to 10A Load Step; and Min. Capacitance

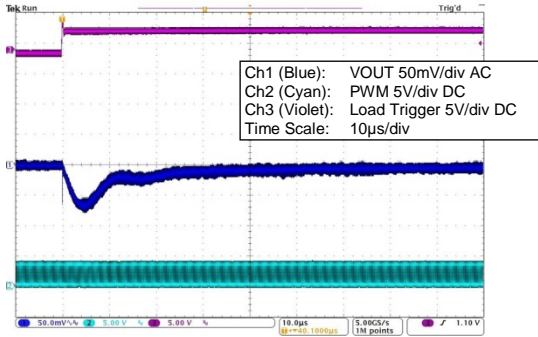

Figure 5.147 ZSPM1508 with Comp1; 10A to 5A Load Step; and Min. Capacitance

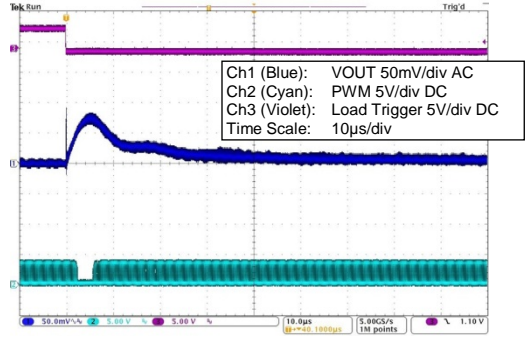

Figure 5.148 ZSPM1508 with Comp1; 5A to 10A Load Step; and Max. Capacitance

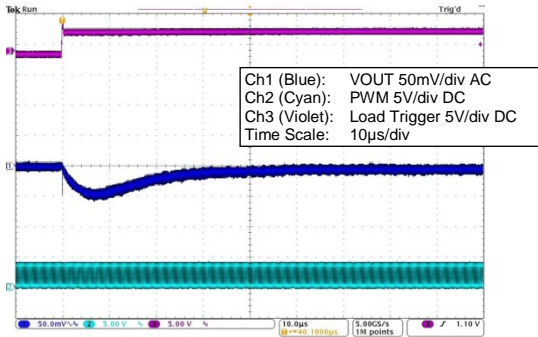

Figure 5.149 ZSPM1508 with Comp1; 10A to 5A Load Step; and Max. Capacitance

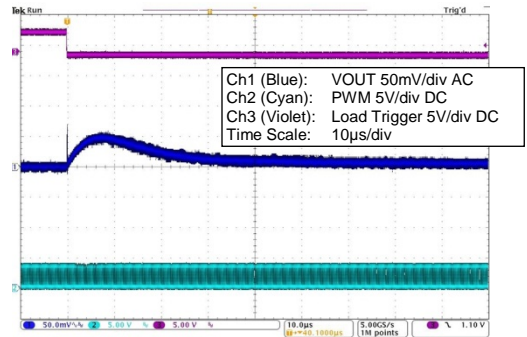
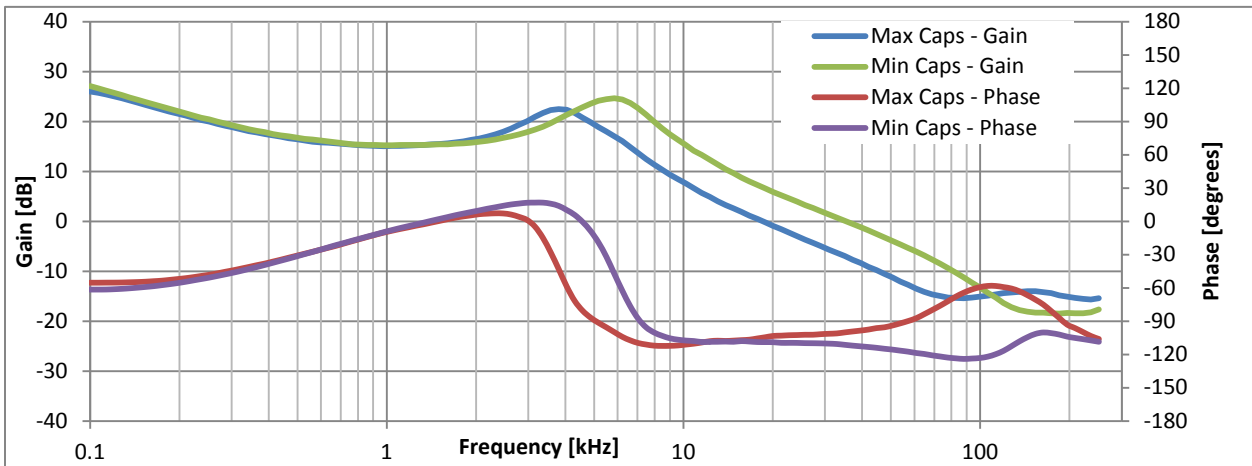

Figure 5.150 Open Loop Bode Plots for ZSPM1508 with Comp1



5.31. ZSPM1508 – Typical Load Transient Response –Capacitor Range 3 – Comp2

Test conditions: $V_{IN} = 12.0V$, $V_{OUT} = 3.30V$

Minimum output capacitance: $2 \times 100\mu F/10V \text{ X5R} + 2 \times 470\mu F/7m\Omega$

Maximum output capacitance: $4 \times 100\mu F/10V \text{ X5R} + 2 \times 47\mu F/10V \text{ X7R} + 4 \times 470\mu F/7m\Omega$

Figure 5.151 ZSPM1508 with Comp2; 5A to 10A Load Step; and Min. Capacitance

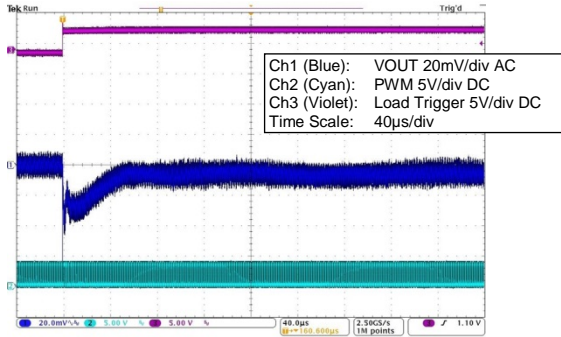

Figure 5.152 ZSPM1508 with Comp2; 10A to 5A Load Step; and Min. Capacitance

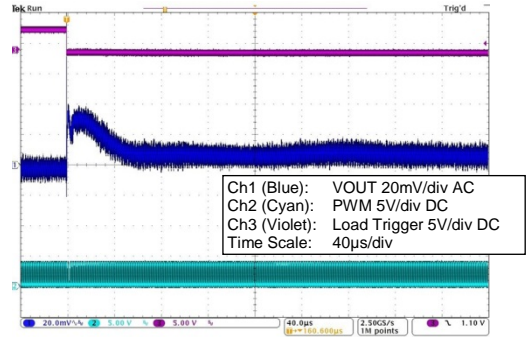

Figure 5.153 ZSPM1508 with Comp2; 5A to 10A Load Step; and Max. Capacitance

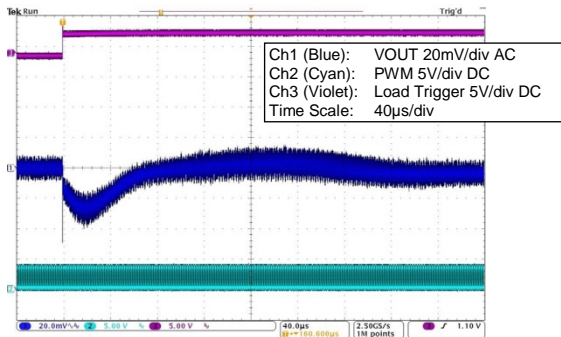

Figure 5.154 ZSPM1508 with Comp2; 10A to 5A Load Step; and Max. Capacitance

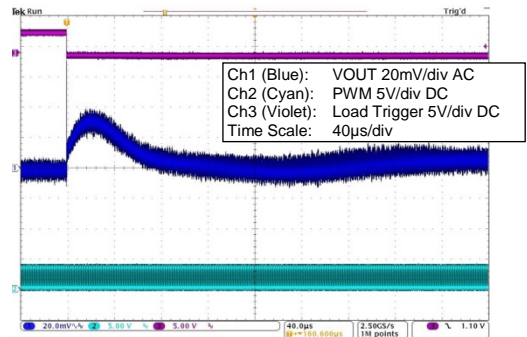
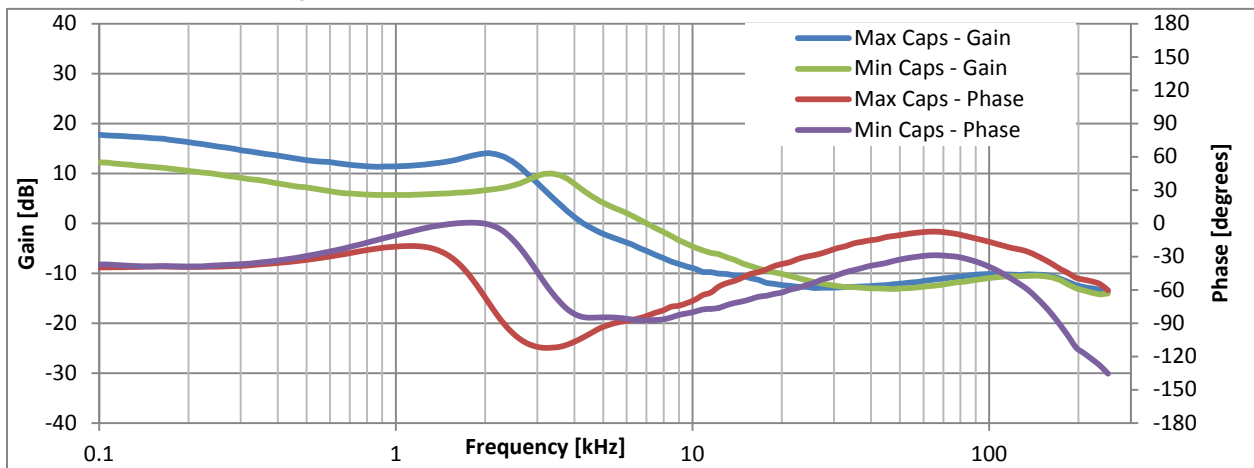

Figure 5.155 Open Loop Bode Plots for ZSPM1508 with Comp2



5.32. ZSPM1508 – Typical Load Transient Response –Capacitor Range 4 – Comp3

Test conditions: $V_{IN} = 12.0V$, $V_{OUT} = 3.30V$

Minimum output capacitance: $5 \times 100\mu F/10V \text{ X5R} + 4 \times 470\mu F/7m\Omega$

Maximum output capacitance: $8 \times 100\mu F/10V \text{ X5R} + 4 \times 47\mu F/10V \text{ X7R} + 6 \times 470\mu F/7m\Omega$

Figure 5.156 ZSPM1508 with Comp3; 5A to 10A Load Step; and Min. Capacitance

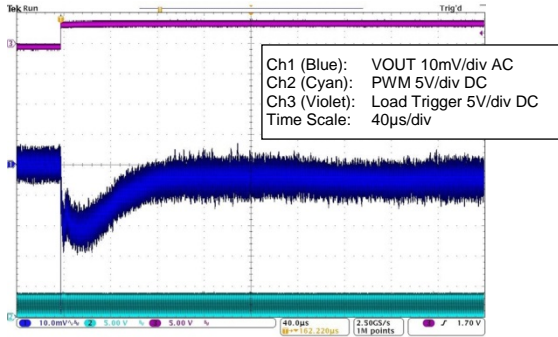

Figure 5.157 ZSPM1508 with Comp3; 10A to 5A Load Step; and Min. Capacitance

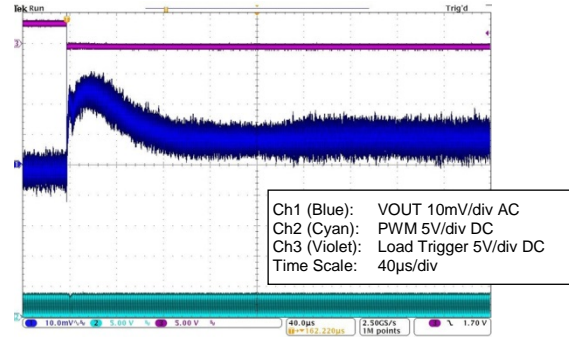

Figure 5.158 ZSPM1508 with Comp3; 5A to 10A Load Step; and Max. Capacitance

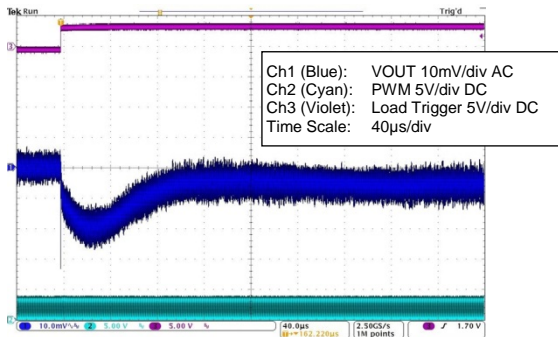

Figure 5.159 ZSPM1508 with Comp3; 10A to 5A Load Step; and Max. Capacitance

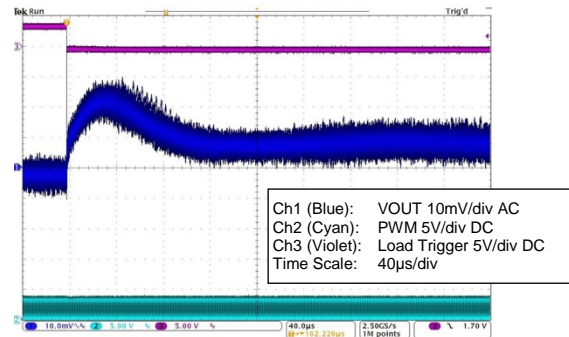
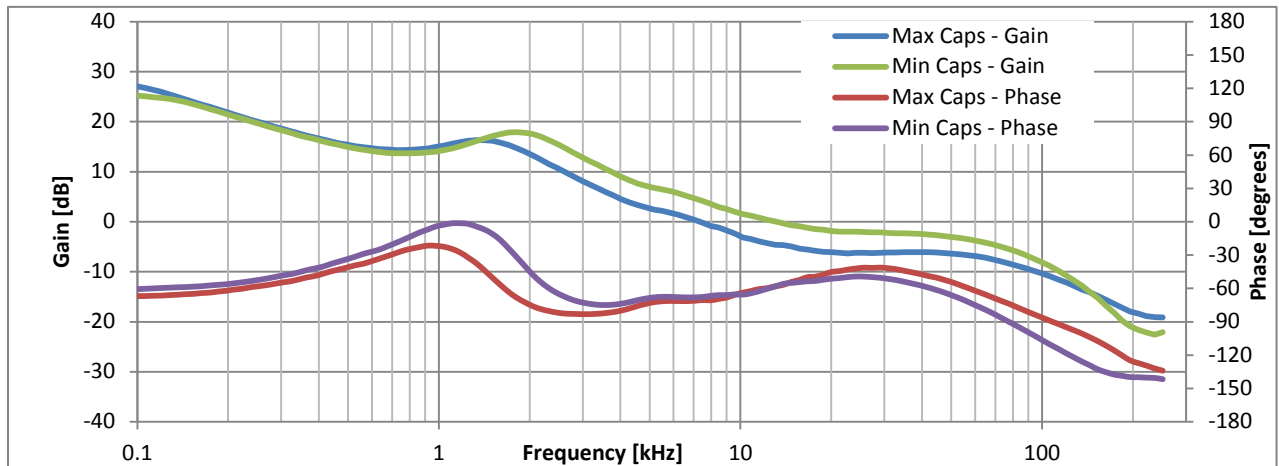

Figure 5.160 Open Loop Bode Plots for ZSPM1508 with Comp3



5.33. ZSPM1509 – Typical Load Transient Response –Capacitor Range 1 – Comp0

Test conditions: $V_{IN} = 12.0V$, $V_{OUT} = 5.00V$

Minimum output capacitance: $2 \times 100\mu F/10 \text{ X5R}$

Maximum output capacitance: $4 \times 100\mu F/10V \text{ X5R} + 2 \times 47\mu F/10V \text{ X7R}$

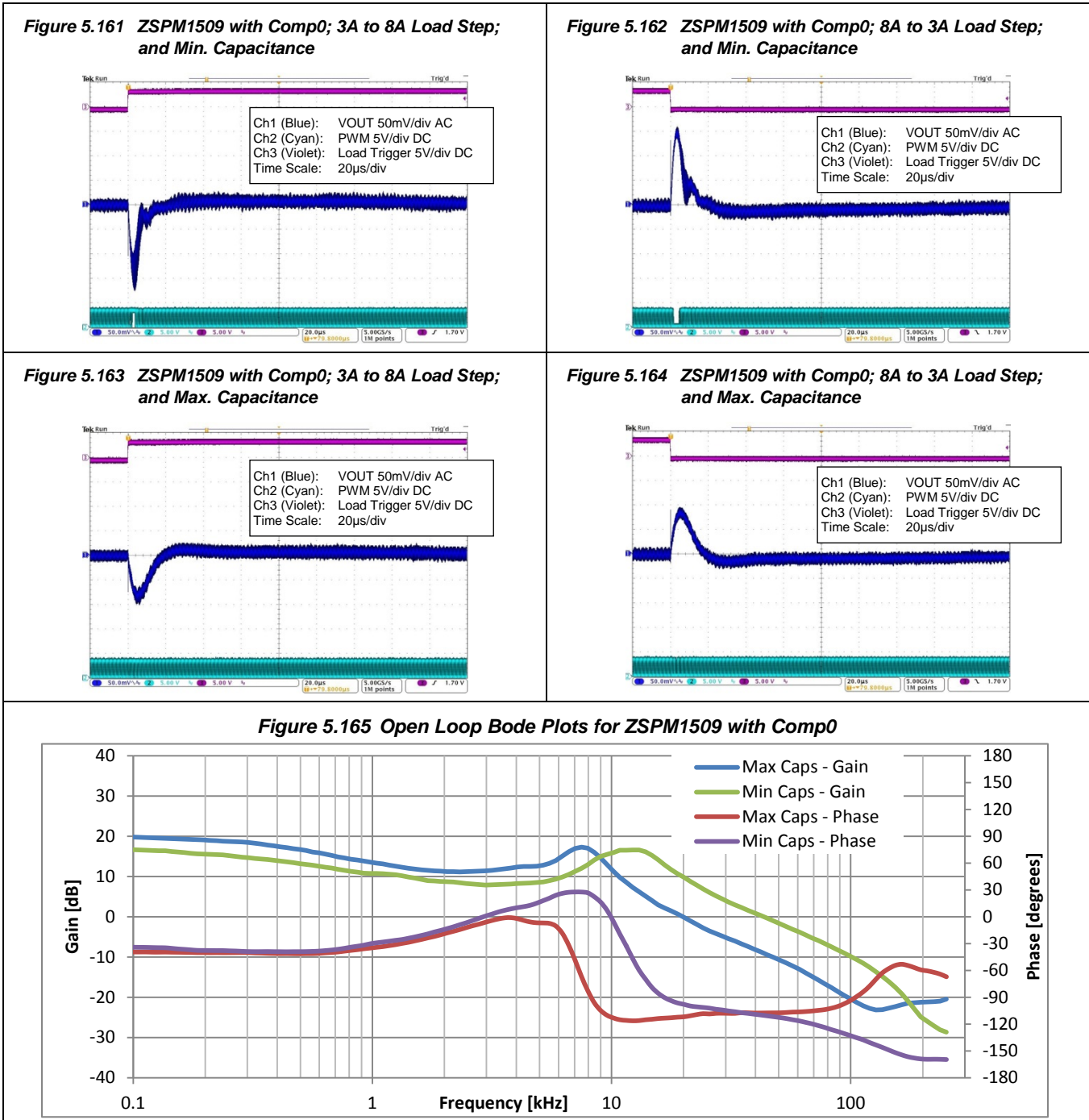

5.34. ZSPM1509 – Typical Load Transient Response –Capacitor Range 2 – Comp1

Test conditions: $V_{IN} = 12.0V$, $V_{OUT} = 5.00V$

Minimum output capacitance: $5 \times 100\mu F/10V \text{ X5R}$

Maximum output capacitance: $8 \times 100\mu F/10V \text{ X5R} + 4 \times 47\mu F/10V \text{ X7R}$

Figure 5.166 ZSPM1509 with Comp1; 3A to 8A Load Step; and Min. Capacitance

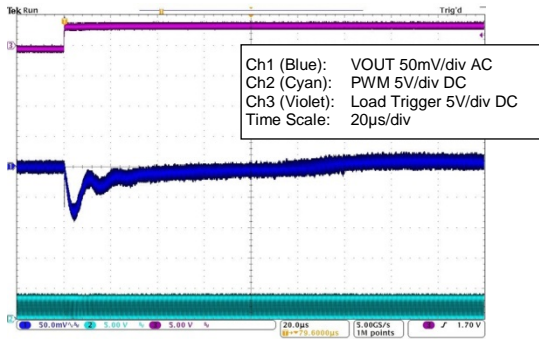

Figure 5.167 ZSPM1509 with Comp1; 8A to 3A Load Step; and Min. Capacitance

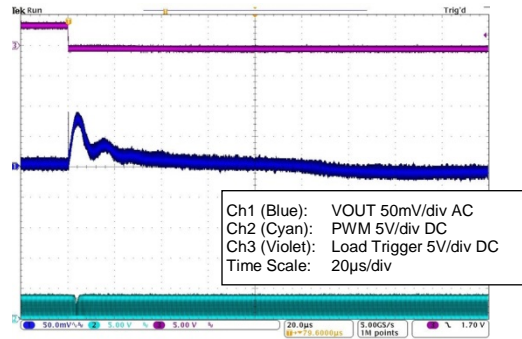

Figure 5.168 ZSPM1509 with Comp1; 3A to 8A Load Step; and Max. Capacitance

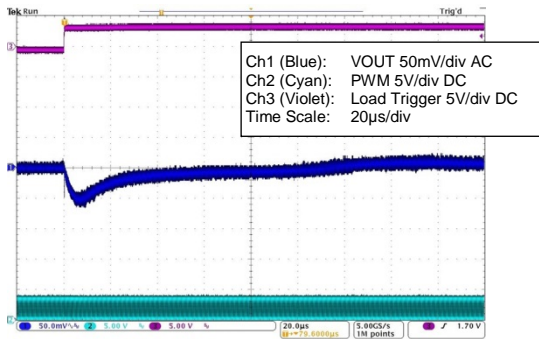

Figure 5.169 ZSPM1509 with Comp1; 8A to 3A Load Step; and Max. Capacitance

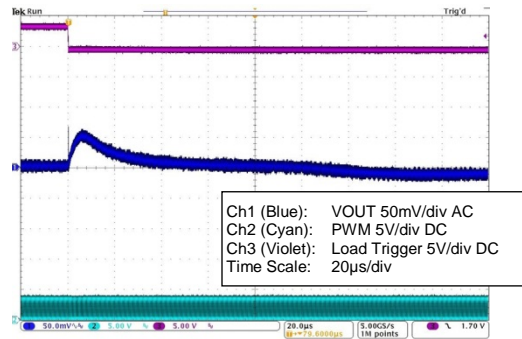
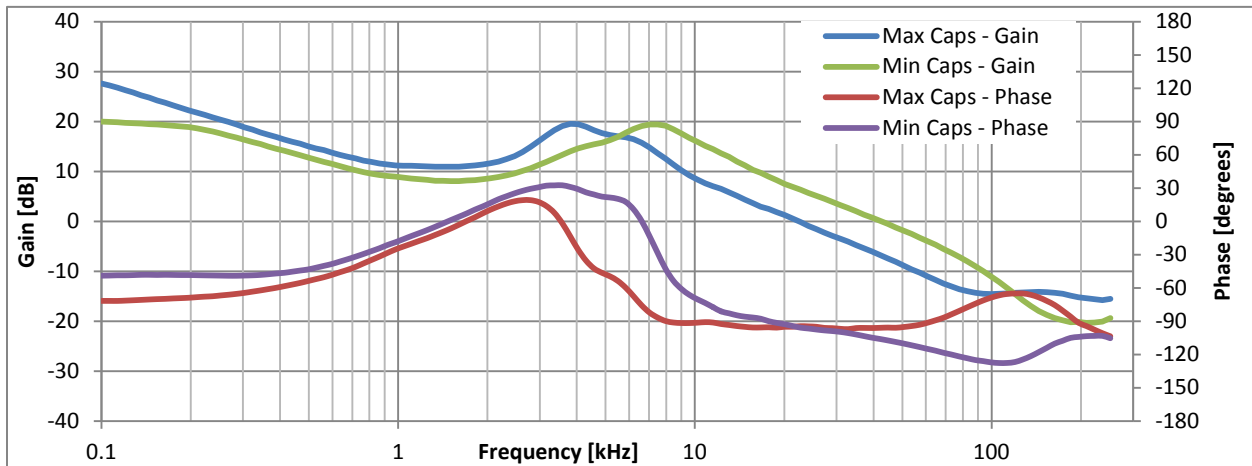

Figure 5.170 Open Loop Bode Plots for ZSPM1509 with Comp1



5.35. ZSPM1509 – Typical Load Transient Response –Capacitor Range 3 – Comp2

Test conditions: $V_{IN} = 12.0V$, $V_{OUT} = 5.00V$

Minimum output capacitance: $2 \times 100\mu F/10V \text{ X5R} + 2 \times 470\mu F/7m\Omega$

Maximum output capacitance: $4 \times 100\mu F/10V \text{ X5R} + 2 \times 47\mu F/10V \text{ X7R} + 4 \times 470\mu F/7m\Omega$

Figure 5.171 ZSPM1509 with Comp2; 3A to 8A Load Step; and Min. Capacitance

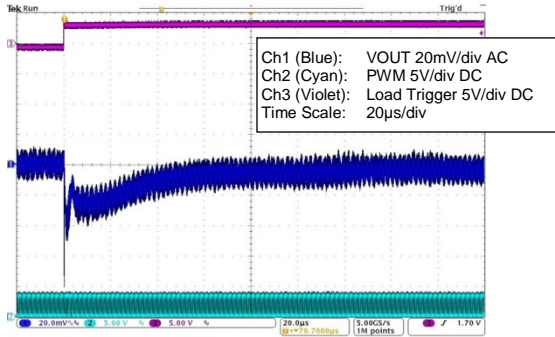

Figure 5.172 ZSPM1509 with Comp2; 8A to 3A Load Step; and Min. Capacitance

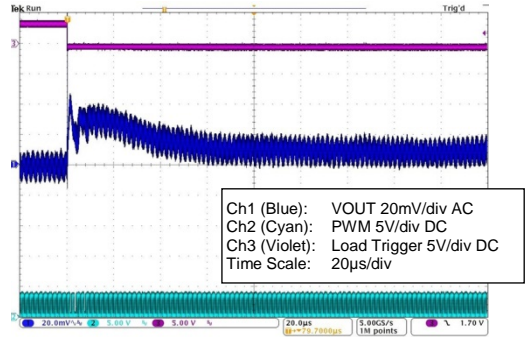

Figure 5.173 ZSPM1509 with Comp2; 3A to 8A Load Step; and Max. Capacitance

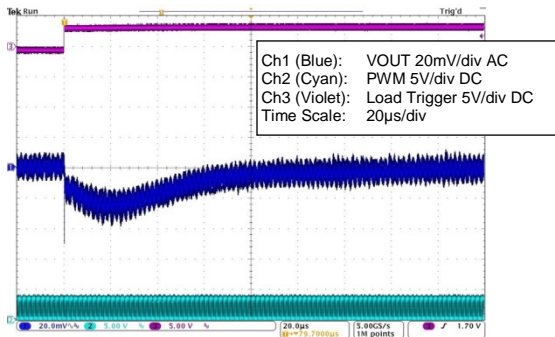

Figure 5.174 ZSPM1509 with Comp2; 8A to 3A Load Step; and Max. Capacitance

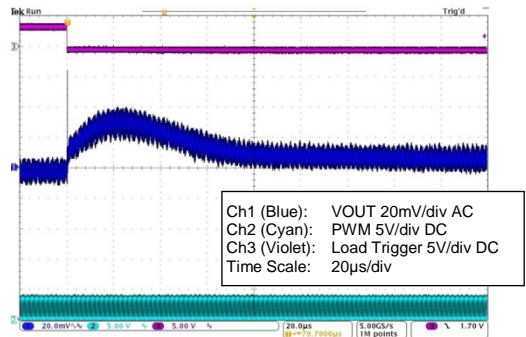
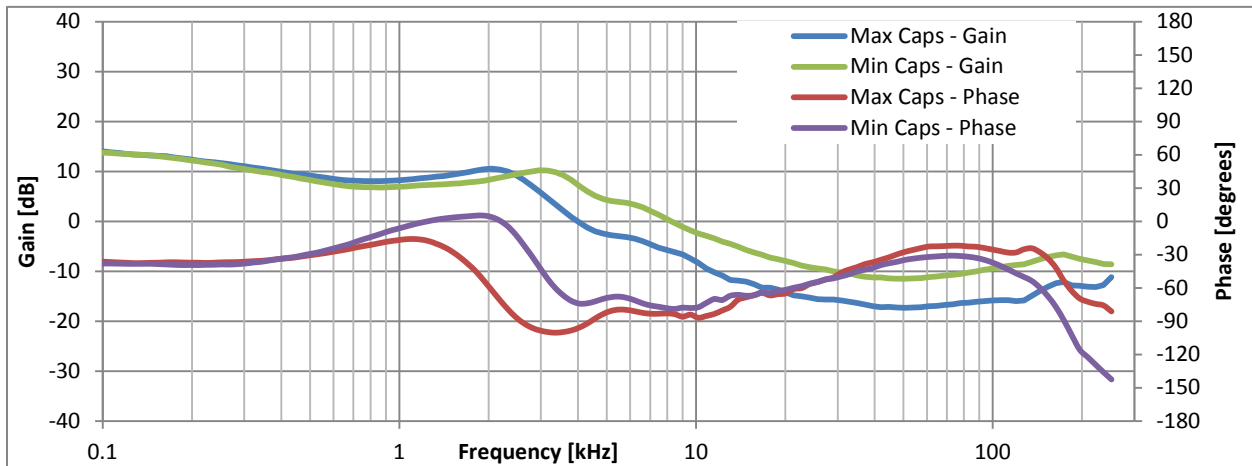

Figure 5.175 Open Loop Bode Plots for ZSPM1509 with Comp2



5.36. ZSPM1509 – Typical Load Transient Response –Capacitor Range 4 – Comp3

Test conditions: $V_{IN} = 12.0V$, $V_{OUT} = 5.00V$

Minimum output capacitance: $5 \times 100\mu F/10V \text{ X5R} + 4 \times 470\mu F/7m\Omega$

Maximum output capacitance: $8 \times 100\mu F/10V \text{ X5R} + 4 \times 47\mu F/10V \text{ X7R} + 6 \times 470\mu F/7m\Omega$

Figure 5.176 ZSPM1509 with Comp3; 3A to 8A Load Step; and Min. Capacitance

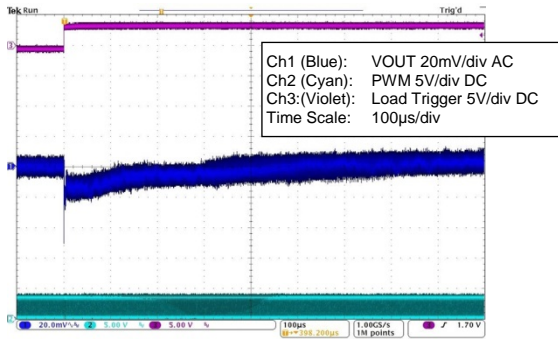

Figure 5.177 ZSPM1509 with Comp3; 8A to 3A Load Step; and Min. Capacitance

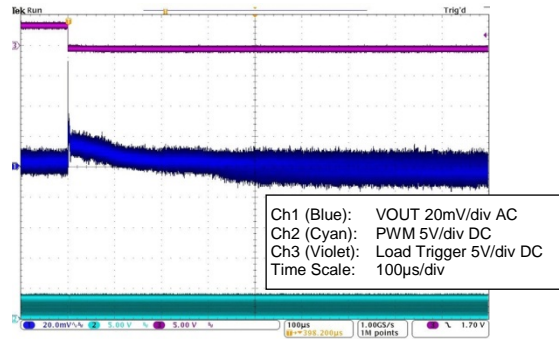

Figure 5.178 ZSPM1509 with Comp3; 3A to 8A Load Step; and Max. Capacitance

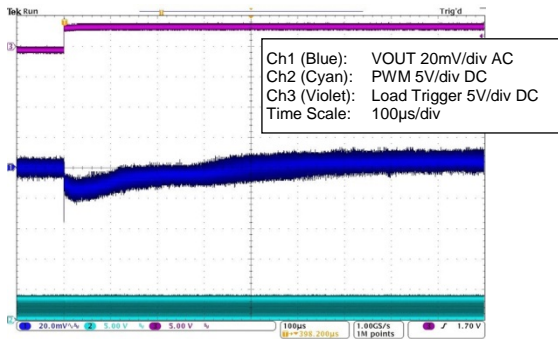

Figure 5.179 ZSPM1509 with Comp3; 8A to 3A Load Step; and Max. Capacitance

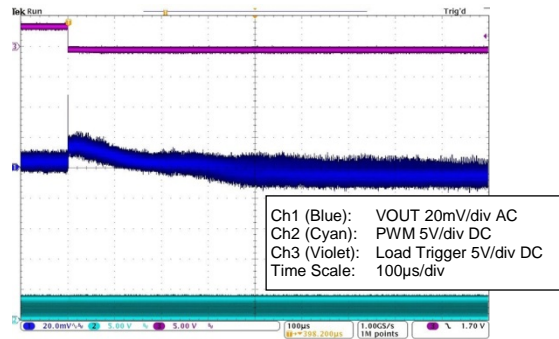
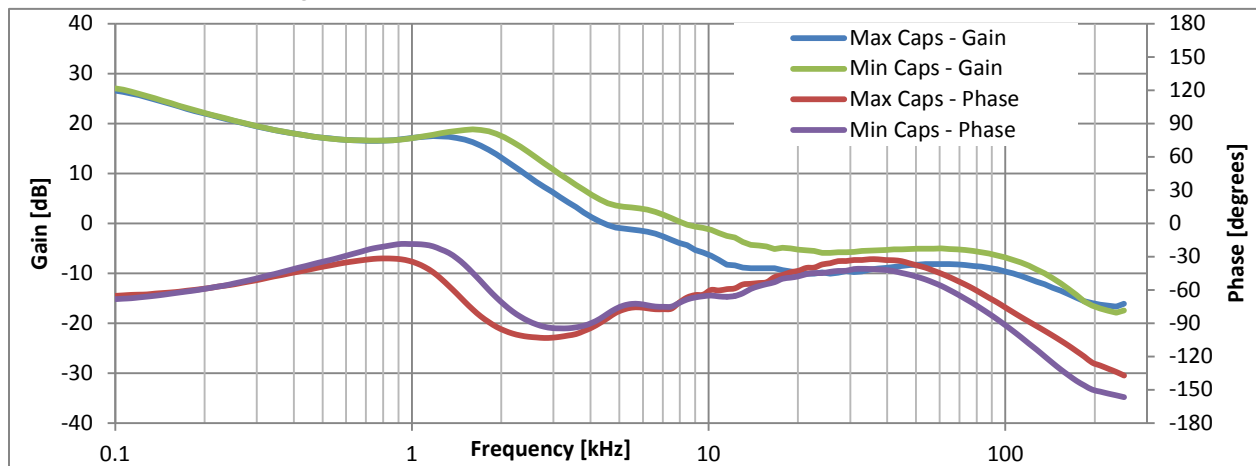

Figure 5.180 Open Loop Bode Plots for ZSPM1509 with Comp3



5.37. ZSPM1511 – Typical Load Transient Response – Capacitor Range #1 – Comp0

Test conditions: $V_{IN} = 12.0V$, $V_{OUT} = 0.85V$

Minimum output capacitance: $2 \times 100\mu F/6.3V \text{ X5R}$

Maximum output capacitance: $4 \times 100\mu F/6.3V \text{ X5R} + 2 \times 47\mu F/10V \text{ X7R}$

Figure 5.181 ZSPM1511 with Comp0; 5A to 15A Load Step; and Min. Capacitance

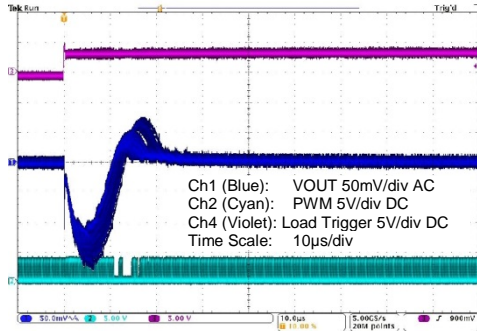

Figure 5.182 ZSPM1511 with Comp0; 15A to 5A Load Step; and Min. Capacitance

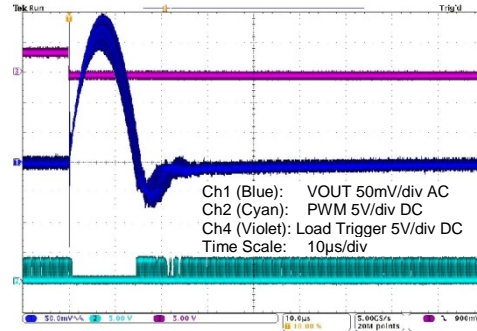

Figure 5.183 ZSPM1511 with Comp0; 5A to 15A Load Step; and Max. Capacitance

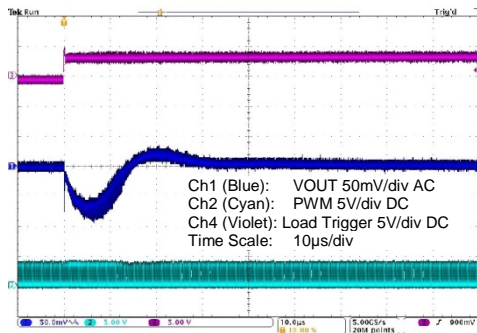

Figure 5.184 ZSPM1511 with Comp0; 15A to 5A Load Step; and Max. Capacitance

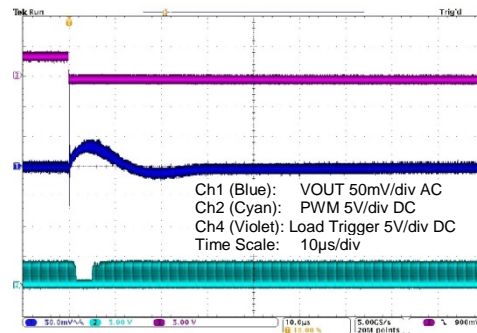
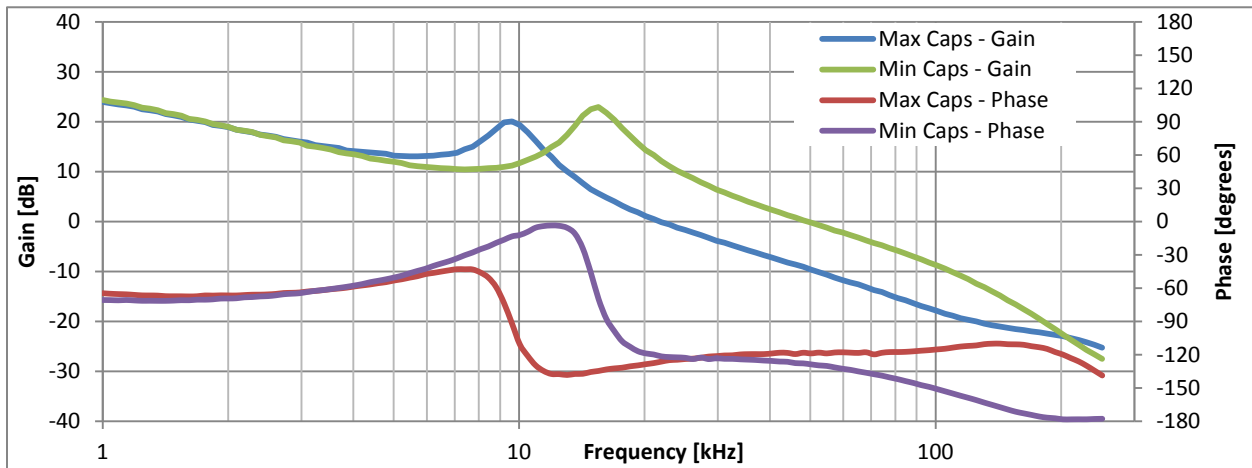

Figure 5.185 Open Loop Bode Plots for ZSPM1511 with Comp0



5.38. ZSPM1511 – Typical Load Transient Response – Capacitor Range #2 – Comp1

Test conditions: $V_{IN} = 12.0V$, $V_{OUT} = 0.85V$

Minimum output capacitance: $5 \times 100\mu F/6.3V \times 5R$

Maximum output capacitance: $8 \times 100\mu F/6.3V \times 5R + 4 \times 47\mu F/10V \times 7R$

Figure 5.186 ZSPM1511 with Comp1; 5A to 15A Load Step; and Min. Capacitance

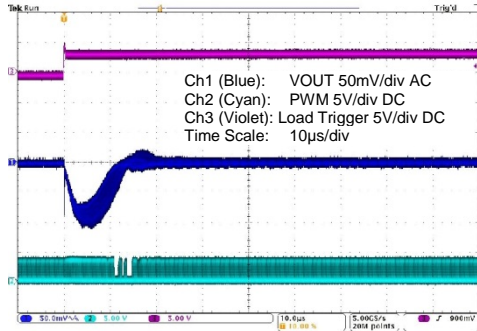

Figure 5.187 ZSPM1511 with Comp1; 15A to 5A Load Step; and Min. Capacitance

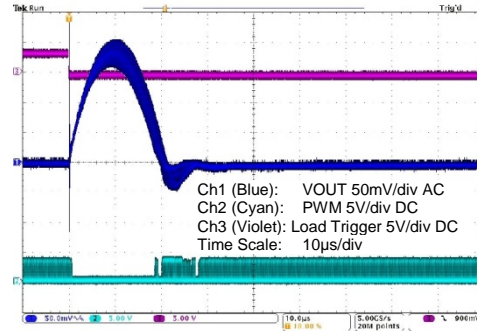

Figure 5.188 ZSPM1511 with Comp1; 5A to 15A Load Step; and Max. Capacitance

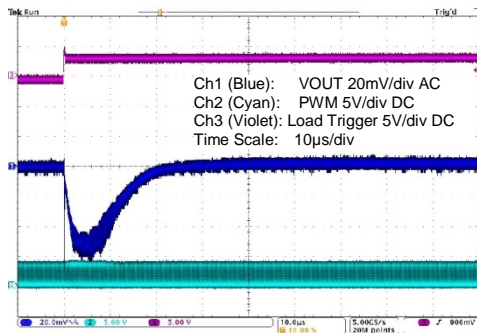

Figure 5.189 ZSPM1511 with Comp1; 15A to 5A Load Step; and Max. Capacitance

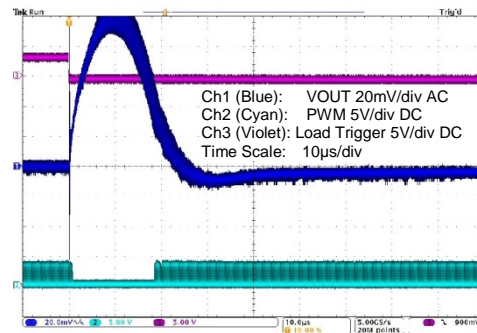
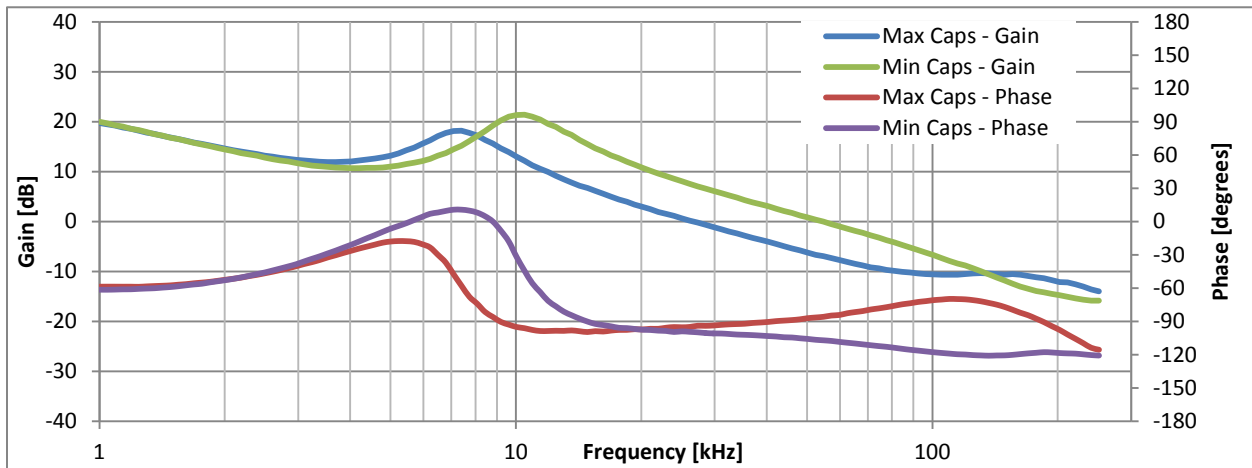

Figure 5.190 Open Loop Bode Plots for ZSPM1511 with Comp1



5.39. ZSPM1511 – Typical Load Transient Response – Capacitor Range #3 – Comp2

Test conditions: $V_{IN} = 12.0V$, $V_{OUT} = 0.85V$

Minimum output capacitance: $2 \times 100\mu F/6.3V \text{ X5R} + 2 \times 470\mu F/7m\Omega$

Maximum output capacitance: $4 \times 100\mu F/6.3V \text{ X5R} + 2 \times 47\mu F/10V \text{ X7R} + 4 \times 470\mu F/7m\Omega$

Figure 5.191 ZSPM1511 with Comp2; 5A to 15A Load Step; and Min. Capacitance

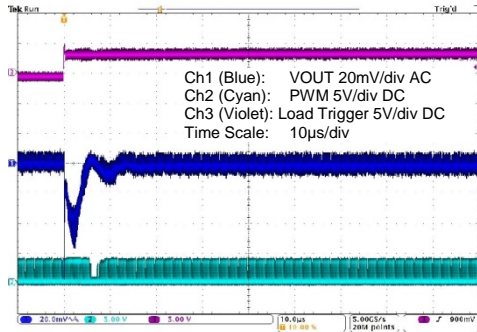

Figure 5.192 ZSPM1511 with Comp2; 15A to 5A Load Step; and Min. Capacitance

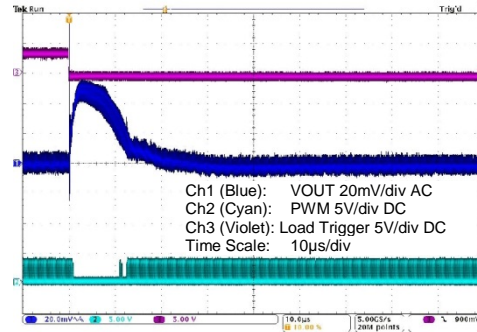

Figure 5.193 ZSPM1511 with Comp2; 5A to 15A Load Step; and Max. Capacitance

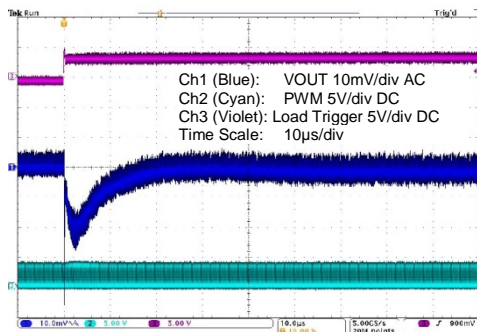

Figure 5.194 ZSPM1511 with Comp2; 15A to 5A Load Step; and Max. Capacitance

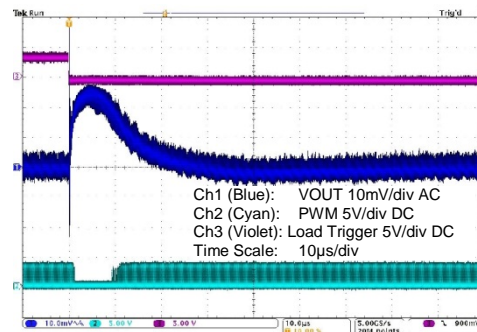
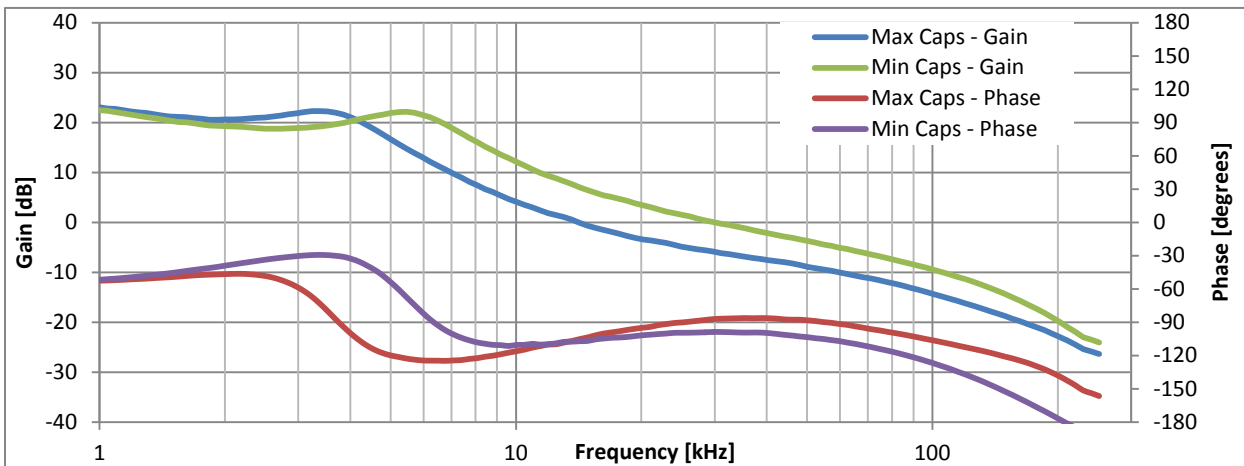

Figure 5.195 Open Loop Bode Plots for ZSPM1511 with Comp2



5.40. ZSPM1511 – Typical Load Transient Response – Capacitor Range #4 – Comp3

Test conditions: $V_{IN} = 12.0V$, $V_{OUT} = 0.85V$

Minimum output capacitance: $5 \times 100\mu F/6.3V \text{ X5R} + 4 \times 470\mu F/7m\Omega$

Maximum output capacitance: $8 \times 100\mu F/6.3V \text{ X5R} + 4 \times 47\mu F/10V \text{ X7R} + 6 \times 470\mu F/7m\Omega$

Figure 5.196 ZSPM1511 with Comp3; 5A to 15A Load Step; and Min. Capacitance

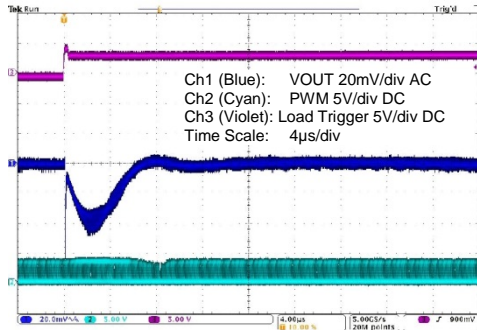

Figure 5.197 ZSPM1511 with Comp3; 15A to 5A Load Step; and Min. Capacitance

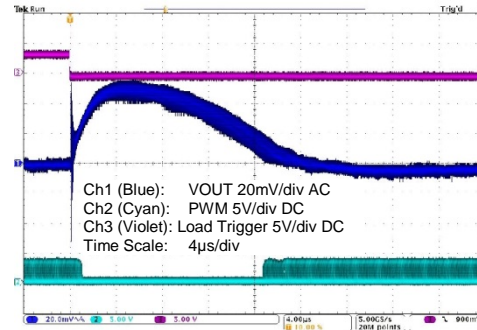

Figure 5.198 ZSPM1511 with Comp3; 5A to 15A Load Step; and Max. Capacitance

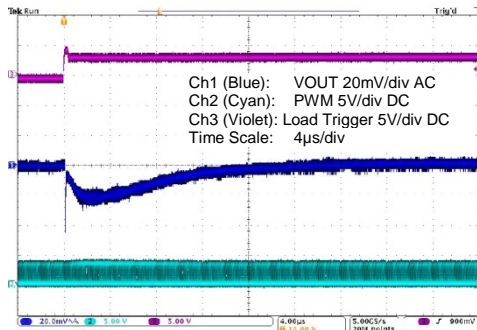

Figure 5.199 ZSPM1511 with Comp3; 15A to 5A Load Step; and Max. Capacitance

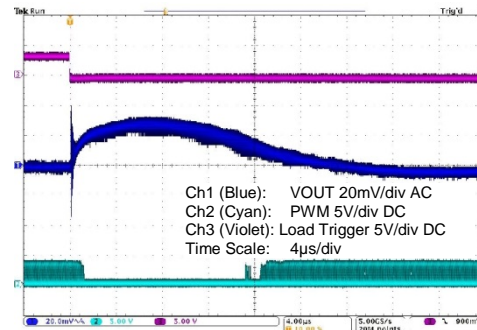
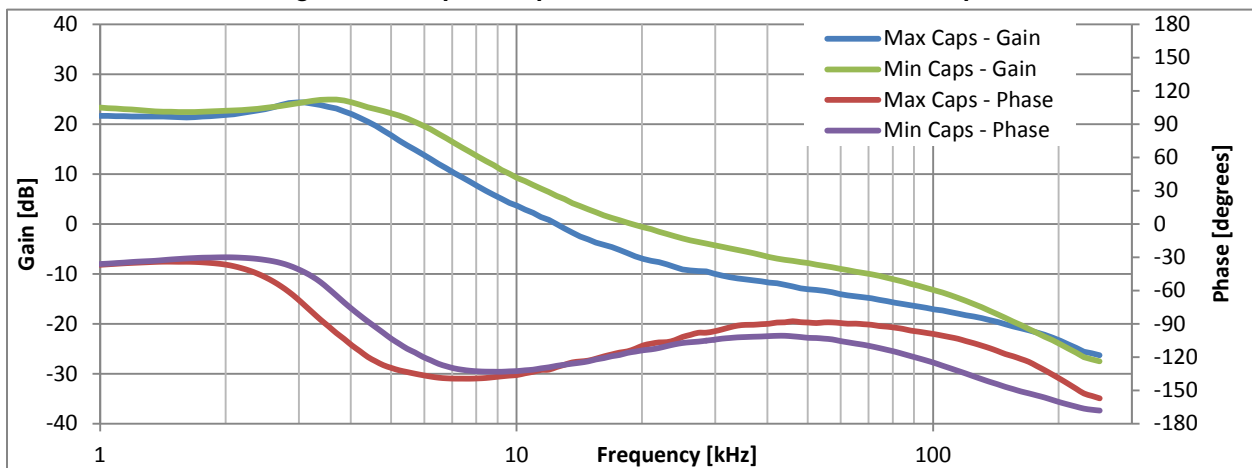

Figure 5.200 Open Loop Bode Plots for ZSPM1511 with Comp3



5.41. ZSPM1512 – Typical Load Transient Response – Capacitor Range #1 – Comp0

Test conditions: $V_{IN} = 12.0V$, $V_{OUT} = 1.00V$

Minimum output capacitance: $2 \times 100\mu F/6.3V \text{ X5R}$

Maximum output capacitance: $4 \times 100\mu F/6.3V \text{ X5R} + 2 \times 47\mu F/10V \text{ X7R}$

Figure 5.201 ZSPM1512 with Comp0; 5A to 15A Load Step; and Min. Capacitance

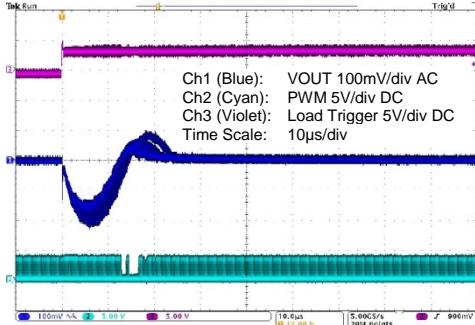

Figure 5.202 ZSPM1512 with Comp0; 15A to 5A Load Step; and Min. Capacitance

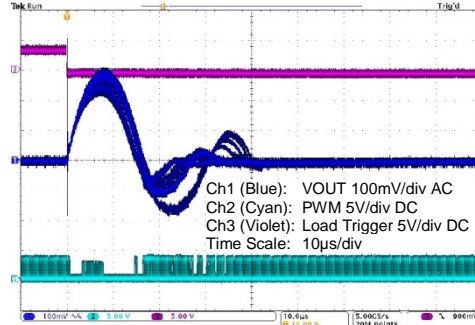

Figure 5.203 ZSPM1512 with Comp0; 5A to 15A Load Step; and Max. Capacitance

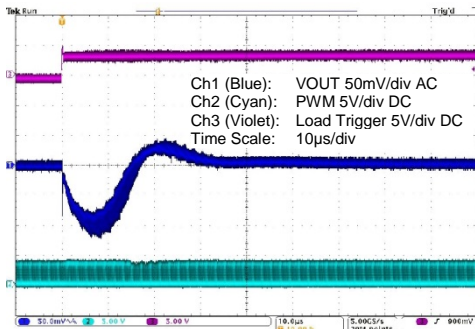

Figure 5.204 ZSPM1512 with Comp0; 15A to 5A Load Step; and Max. Capacitance

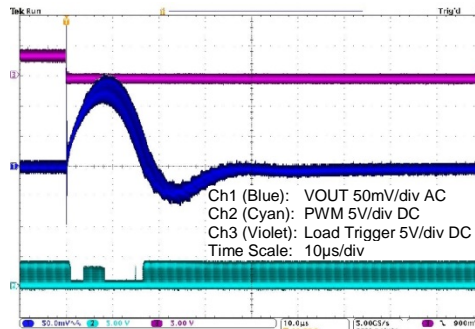
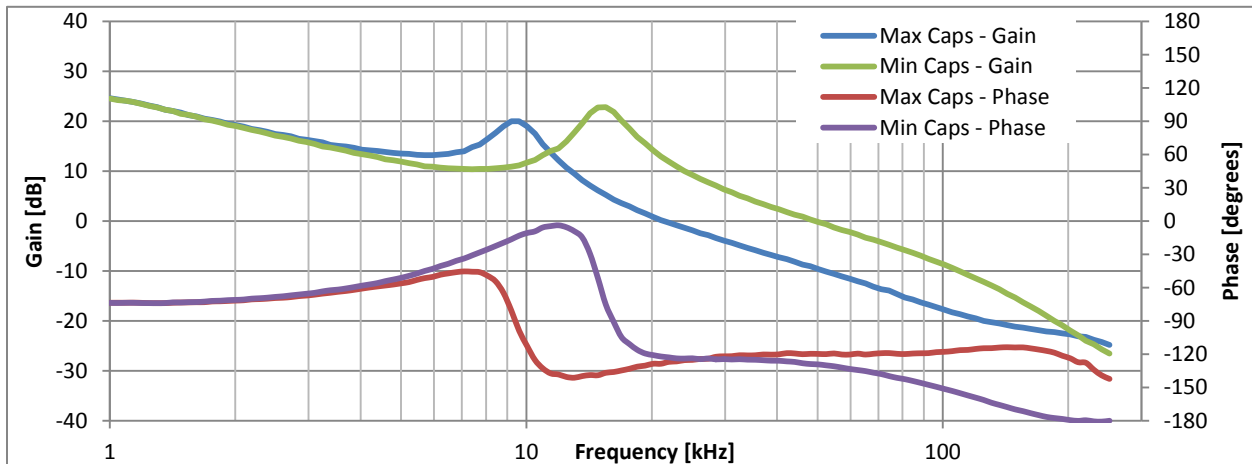

Figure 5.205 Open Loop Bode Plots for ZSPM1512 with Comp0



5.42. ZSPM1512 – Typical Load Transient Response – Capacitor Range #2 – Comp1

Test conditions: $V_{IN} = 12.0V$, $V_{OUT} = 1.00V$

Minimum output capacitance: $5 \times 100\mu F/6.3V \text{ X5R}$

Maximum output capacitance: $8 \times 100\mu F/6.3V \text{ X5R} + 4 \times 47\mu F/10V \text{ X7R}$

Figure 5.206 ZSPM1512 with Comp1; 5A to 15A Load Step; and Min. Capacitance

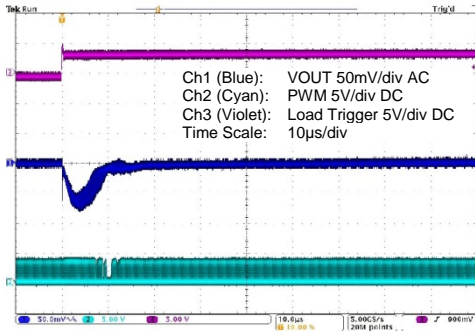

Figure 5.207 ZSPM1512 with Comp1; 15A to 5A Load Step; and Min. Capacitance

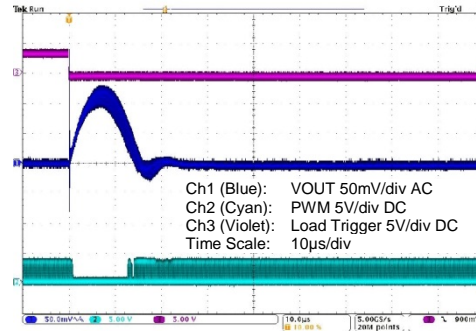

Figure 5.208 ZSPM1512 with Comp1; 5A to 15A Load Step; and Max. Capacitance

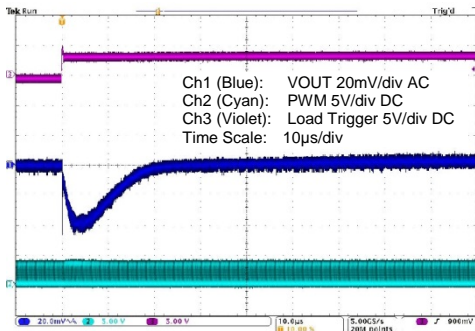

Figure 5.209 ZSPM1512 with Comp1; 15A to 5A Load Step; and Max. Capacitance

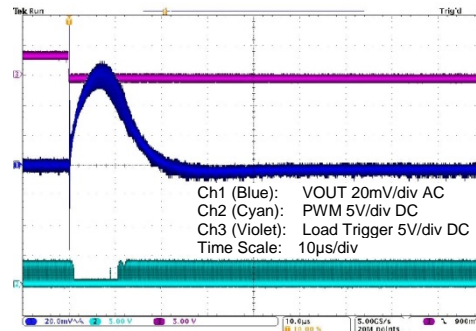
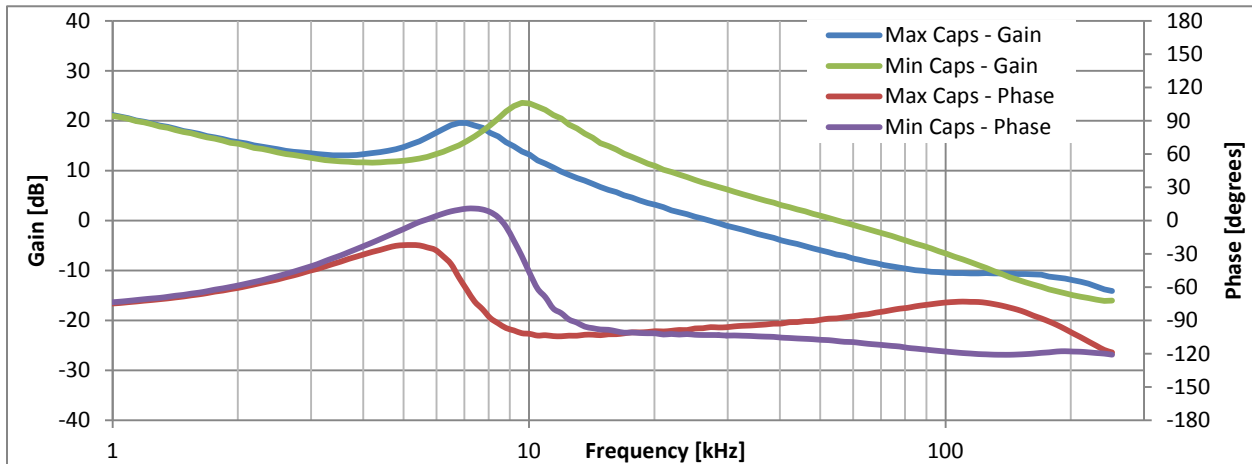

Figure 5.210 Open Loop Bode Plots for ZSPM1512 with Comp1



5.43. ZSPM1512 – Typical Load Transient Response – Capacitor Range #3 – Comp2

Test conditions: $V_{IN} = 12.0V$, $V_{OUT} = 1.00V$

Minimum output capacitance: $2 \times 100\mu F/6.3V \text{ X5R} + 2 \times 470\mu F/7m\Omega$

Maximum output capacitance: $4 \times 100\mu F/6.3V \text{ X5R} + 2 \times 47\mu F/10V \text{ X7R} + 4 \times 470\mu F/7m\Omega$

Figure 5.211 ZSPM1512 with Comp2; 5A to 15A Load Step; and Min. Capacitance

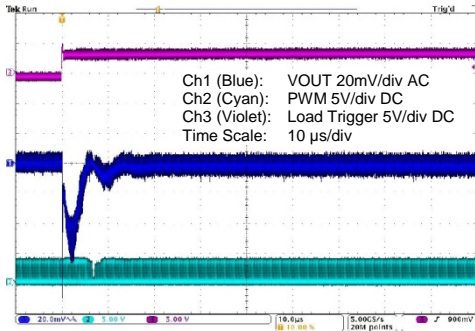

Figure 5.212 ZSPM1512 with Comp2; 15A to 5A Load Step; and Min. Capacitance

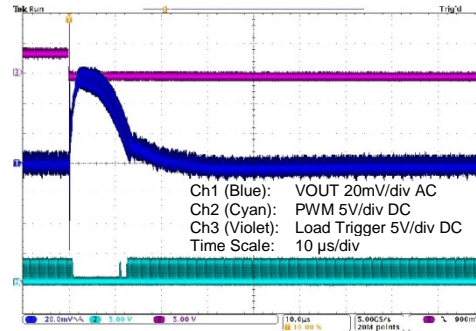

Figure 5.213 ZSPM1512 with Comp2; 5A to 15A Load Step; and Max. Capacitance

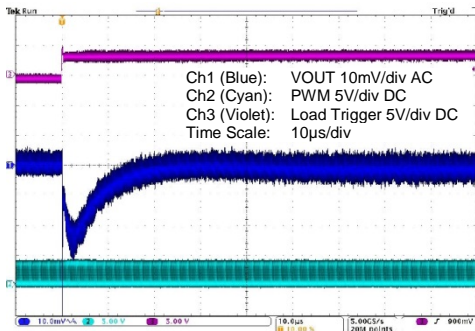

Figure 5.214 ZSPM1512 with Comp2; 15A to 5A Load Step; and Max. Capacitance

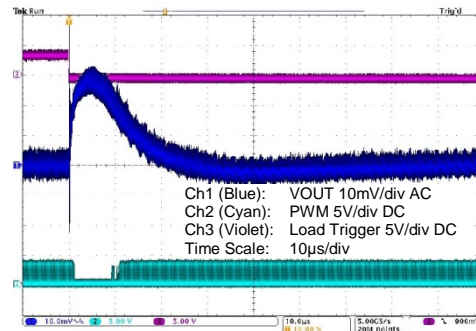
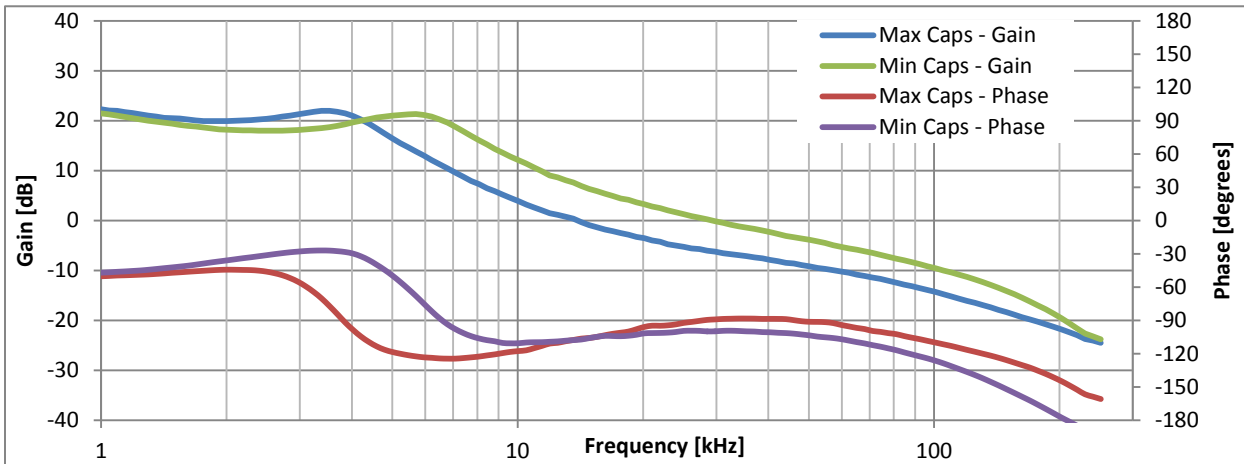

Figure 5.215 Open Loop Bode Plots for ZSPM1512 with Comp2



5.44. ZSPM1512 – Typical Load Transient Response – Capacitor Range #4 – Comp3

Test conditions: $V_{IN} = 12.0V$, $V_{OUT} = 1.00V$

Minimum output capacitance: $5 \times 100\mu F/6.3V \text{ X5R} + 4 \times 470\mu F/7m\Omega$

Maximum output capacitance: $8 \times 100\mu F/6.3V \text{ X5R} + 4 \times 47\mu F/10V \text{ X7R} + 6 \times 470\mu F/7m\Omega$

Figure 5.216 ZSPM1512 with Comp3; 5A to 15A Load Step; and Min. Capacitance

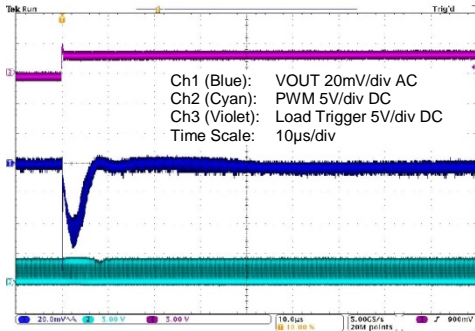

Figure 5.217 ZSPM1512 with Comp3; 15A to 5A Load Step; and Min. Capacitance

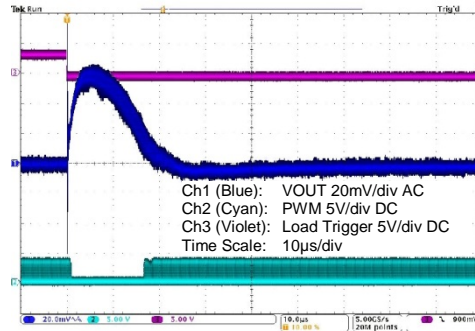

Figure 5.218 ZSPM1512 with Comp3; 5A to 15A Load Step; and Max. Capacitance

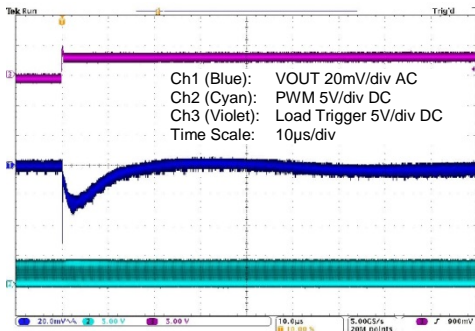

Figure 5.219 ZSPM1512 with Comp3; 15A to 5A Load Step; and Max. Capacitance

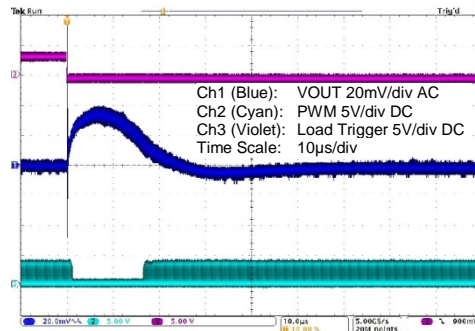
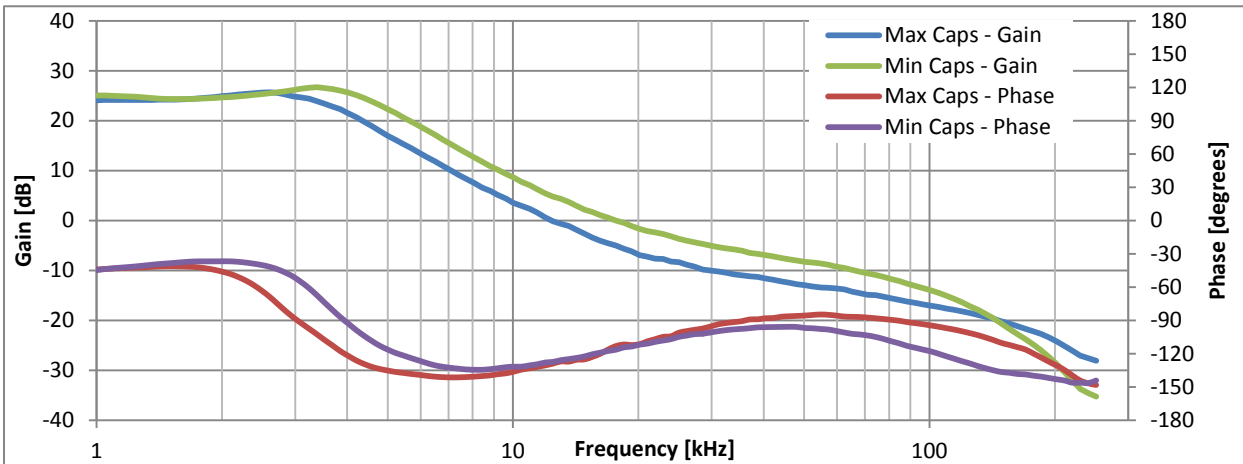

Figure 5.220 Open Loop Bode Plots for ZSPM1512 with Comp3



5.45. ZSPM1513 – Typical Load Transient Response – Capacitor Range #1 – Comp0

Test conditions: $V_{IN} = 12.0V$, $V_{OUT} = 1.20V$

Minimum output capacitance: $2 \times 100\mu F/6.3V \text{ X5R}$

Maximum output capacitance: $4 \times 100\mu F/6.3V \text{ X5R} + 2 \times 47\mu F/10V \text{ X7R}$

Figure 5.221 ZSPM1513 with Comp0; 5A to 15A Load Step; and Min. Capacitance

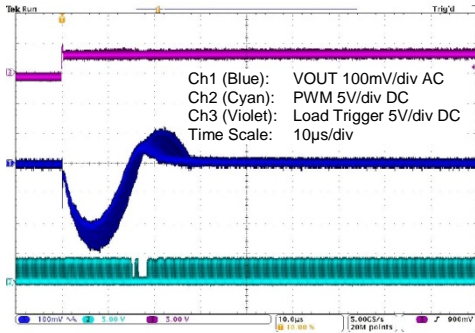

Figure 5.222 ZSPM1513 with Comp0; 15A to 5A Load Step; and Min. Capacitance

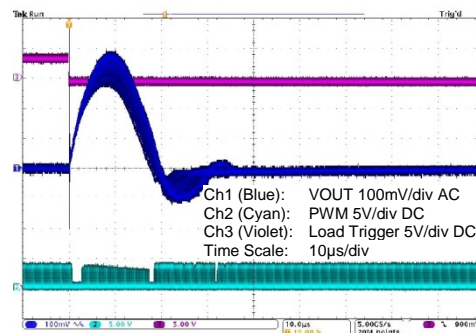

Figure 5.223 ZSPM1513 with Comp0; 5A to 15A Load Step; and Max. Capacitance

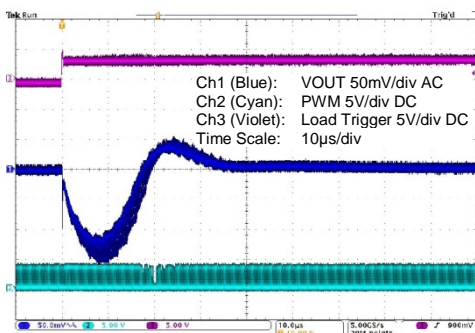

Figure 5.224 ZSPM1513 with Comp0; 15A to 5A Load Step; and Max. Capacitance

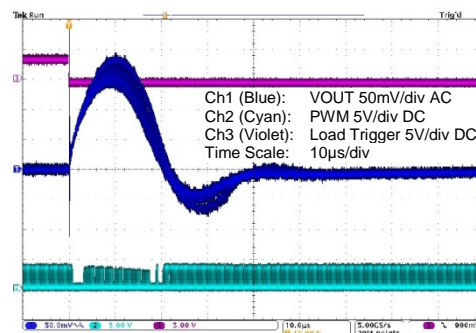
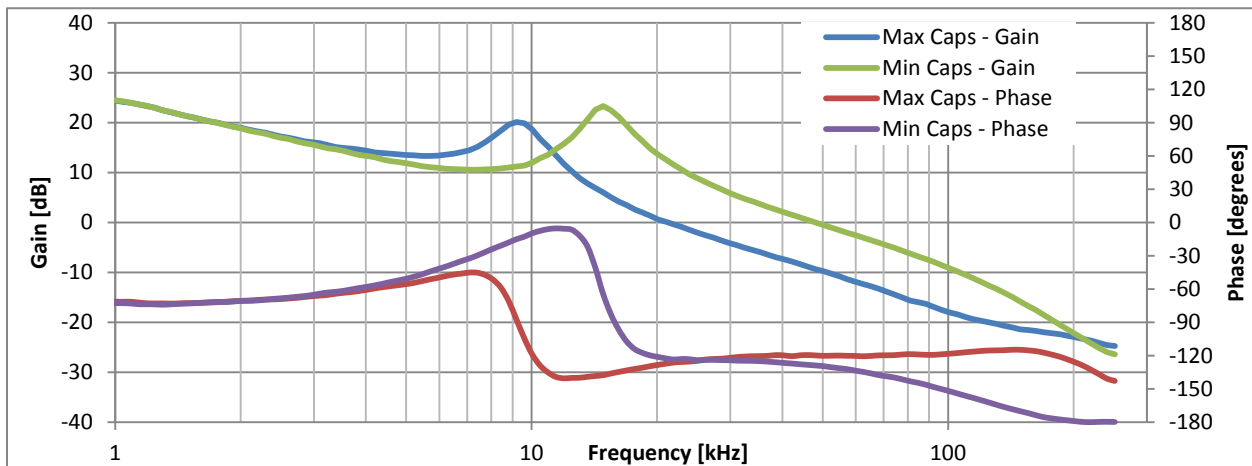

Figure 5.225 Open Loop Bode Plots for ZSPM1513 with Comp0



5.46. ZSPM1513 – Typical Load Transient Response – Capacitor Range #2 – Comp1

Test conditions: $V_{IN} = 12.0V$, $V_{OUT} = 1.20V$

Minimum output capacitance: $5 \times 100\mu F/6.3V \text{ X5R}$

Maximum output capacitance: $8 \times 100\mu F/6.3V \text{ X5R} + 4 \times 47\mu F/10V \text{ X7R}$

Figure 5.226 ZSPM1513 with Comp1; 5A to 15A Load Step; and Min. Capacitance

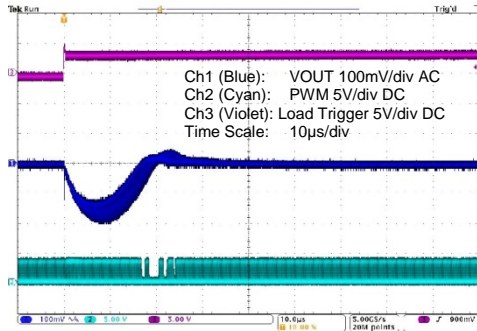

Figure 5.227 ZSPM1513 with Comp1; 15A to 5A Load Step; and Min. Capacitance

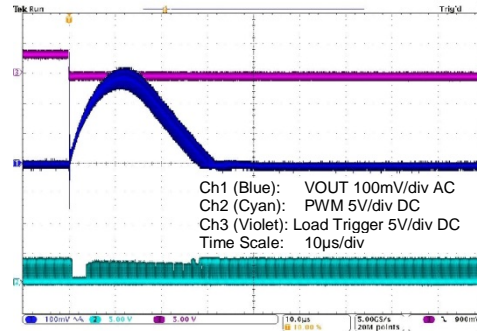

Figure 5.228 ZSPM1513 with Comp1; 5 to 15A Load Step; and Max. Capacitance

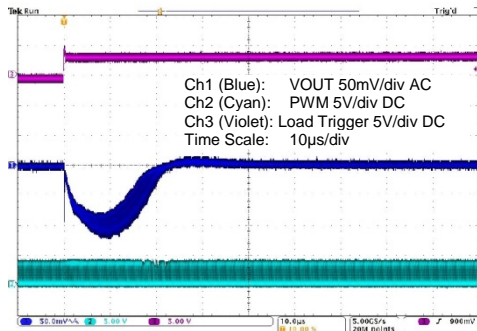

Figure 5.229 ZSPM1513 with Comp1; 15 to 5A Load Step; and Max. Capacitance

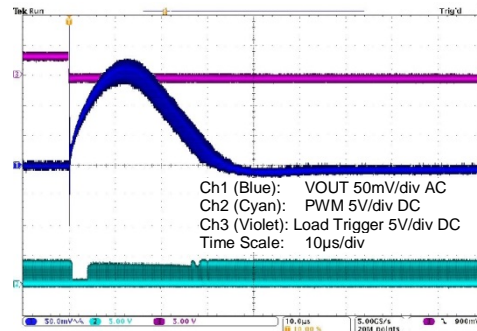
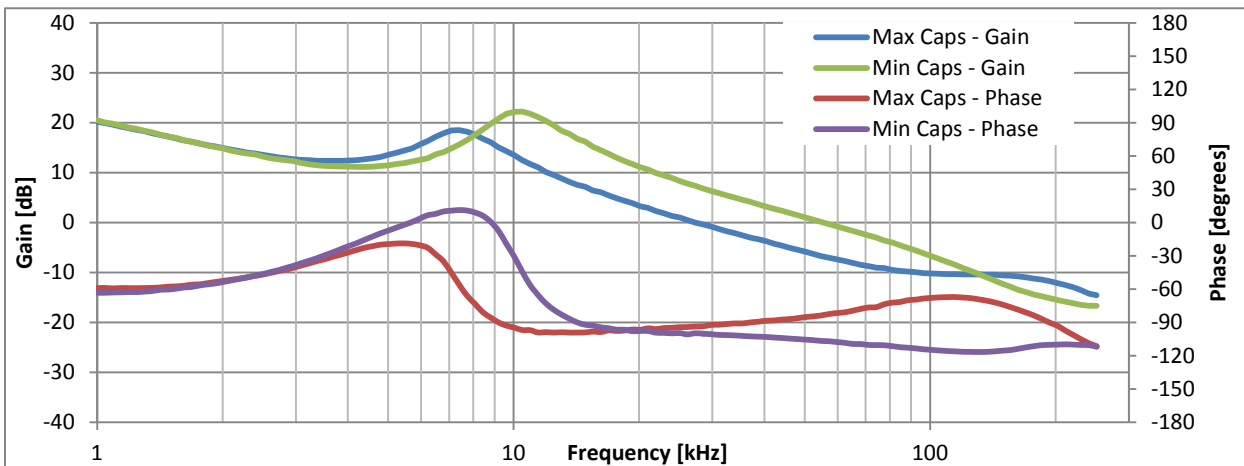

Figure 5.230 Open Loop Bode Plots for ZSPM1513 with Comp1



5.47. ZSPM1513 – Typical Load Transient Response – Capacitor Range #3 – Comp2

Test conditions: $V_{IN} = 12.0V$, $V_{OUT} = 1.20V$

Minimum output capacitance: $2 \times 100\mu F/6.3V \text{ X5R} + 2 \times 470\mu F/7m\Omega$

Maximum output capacitance: $4 \times 100\mu F/6.3V \text{ X5R} + 2 \times 47\mu F/10V \text{ X7R} + 4 \times 470\mu F/7m\Omega$

Figure 5.231 ZSPM1513 with Comp2; 5A to 15A Load Step; and Min. Capacitance

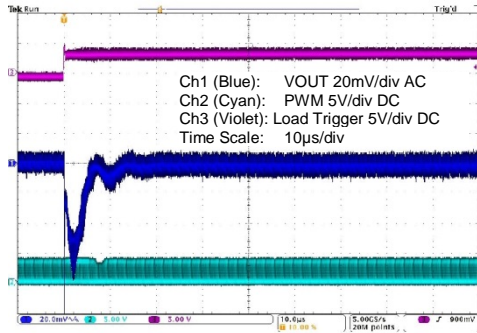

Figure 5.232 ZSPM1513 with Comp2; 15A to 5A Load Step; and Min. Capacitance

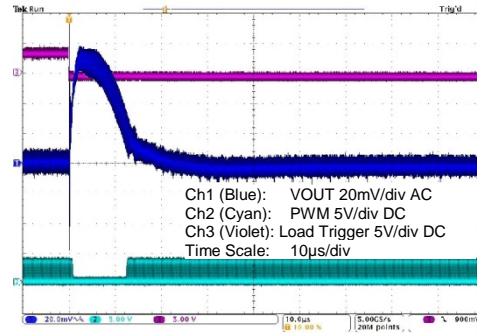

Figure 5.233 ZSPM1513 with Comp2; 5A to 15A Load Step; and Max. Capacitance

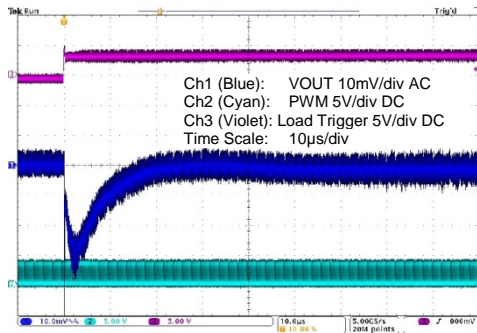

Figure 5.234 ZSPM1513 with Comp2; 15A to 5A Load Step; and Max. Capacitance

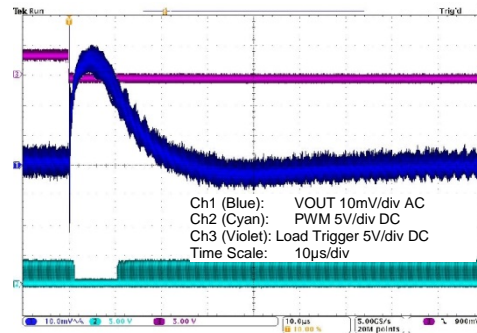
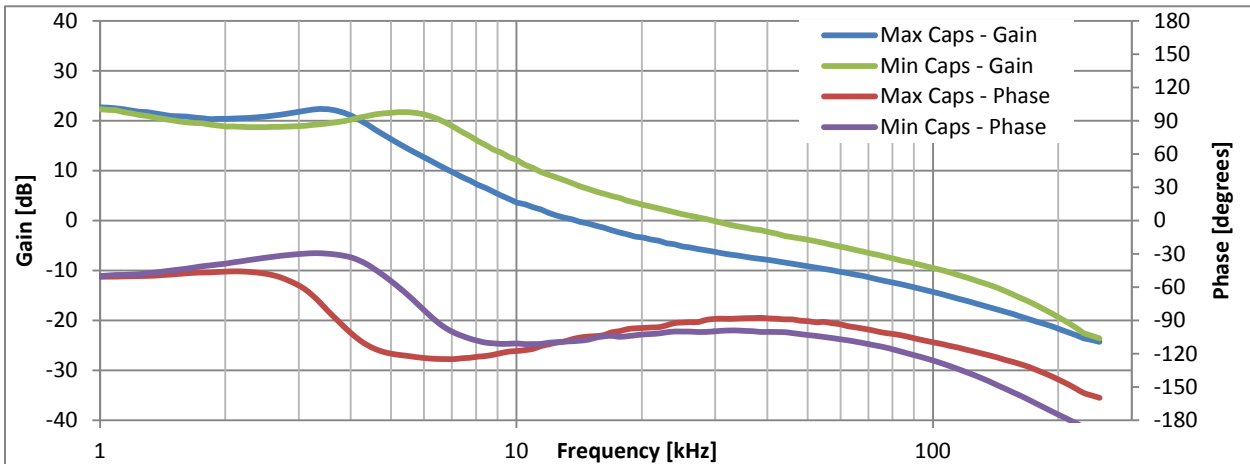

Figure 5.235 Open Loop Bode Plots for ZSPM1513 with Comp2



5.48. ZSPM1513 – Typical Load Transient Response – Capacitor Range #4 – Comp3

Test conditions: $V_{IN} = 12.0V$, $V_{OUT} = 1.20V$

Minimum output capacitance: $5 \times 100\mu F/6.3V \text{ X5R} + 4 \times 470\mu F/7m\Omega$

Maximum output capacitance: $8 \times 100\mu F/6.3V \text{ X5R} + 4 \times 47\mu F/10V \text{ X7R} + 6 \times 470\mu F/7m\Omega$

Figure 5.236 ZSPM1513 with Comp3; 5A to 15A Load Step; and Min. Capacitance

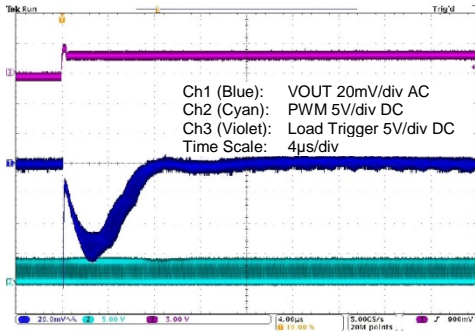

Figure 5.237 ZSPM1513 with Comp3; 15A to 5A Load Step; and Min. Capacitance

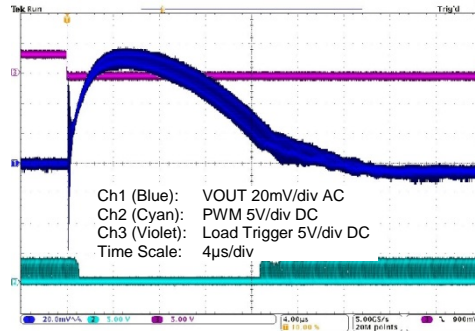

Figure 5.238 ZSPM1513 with Comp3; 5A to 15A Load Step; and Max. Capacitance

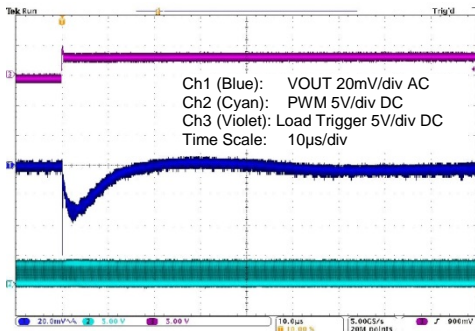

Figure 5.239 ZSPM1513 with Comp3; 15A to 5A Load Step; and Max. Capacitance

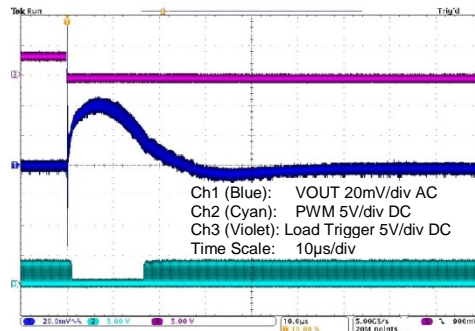
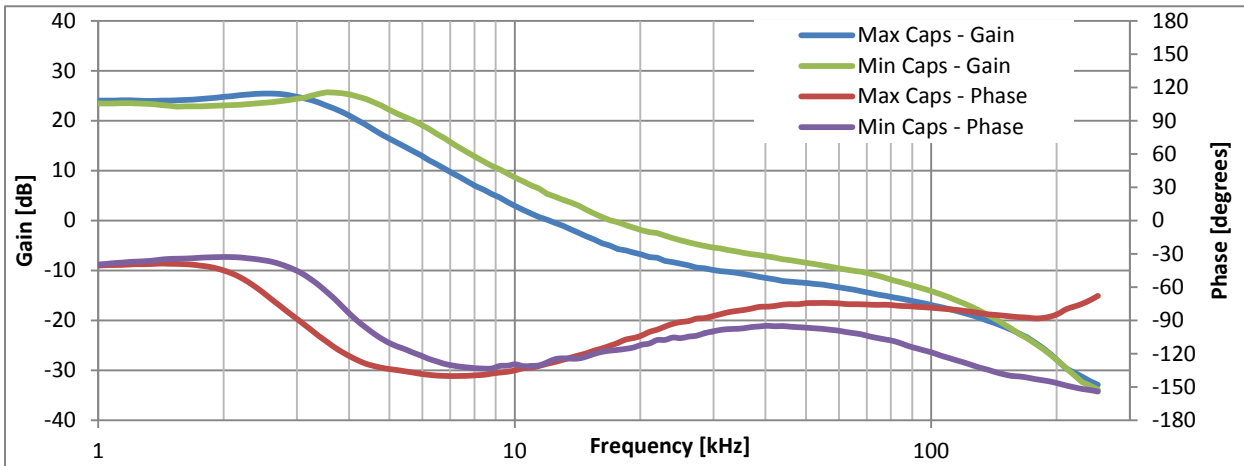

Figure 5.240 Open Loop Bode Plots for ZSPM1513 with Comp3



5.49. Typical Efficiency Curves – ZSPM1502 with ZSPM9000, ZSPM9015, and ZSPM9060 DrMOS

The following graph shows typical efficiency curves for the ZSPM1502 with three different IDT DrMOS power stage options: the ZSPM9000, ZSPM9015, and ZSPM9060. (Note: The ZSPM1502 is also compatible with the ZSPM9010, which is not shown.)

Figure 5.241 Typical Efficiency Curves: ZSPM1502 with ZSPM9000, ZSPM9015, and ZSPM9060 DrMOS ($V_{IN} = 12V$; $V_{out} = 1.0V$)

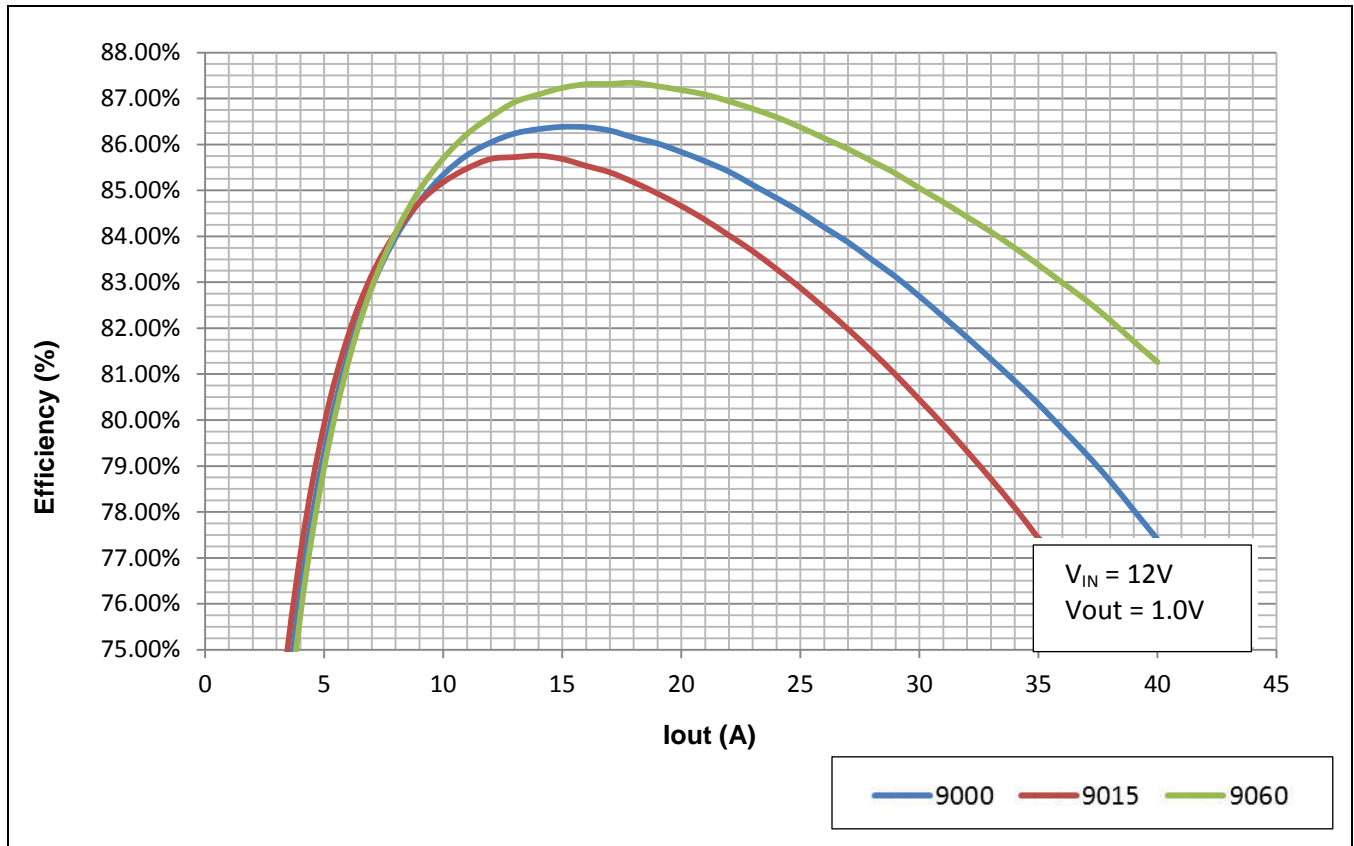

5.50. Typical Efficiency Curves – ZSPM9000 DrMOS with ZSPM1504, ZSPM1505, and ZSPM1506

The following graph shows typical efficiency curves for the ZSPM9000 power stage with three different ZSPM15xx controllers: the ZSPM1504, ZSPM1505, and ZSPM1506.

Figure 5.242 Typical Efficiency Curves: ZSPM9000 DrMOS with ZSPM1504, ZSPM1505, and ZSPM1506 ($V_{IN} = 12V$)

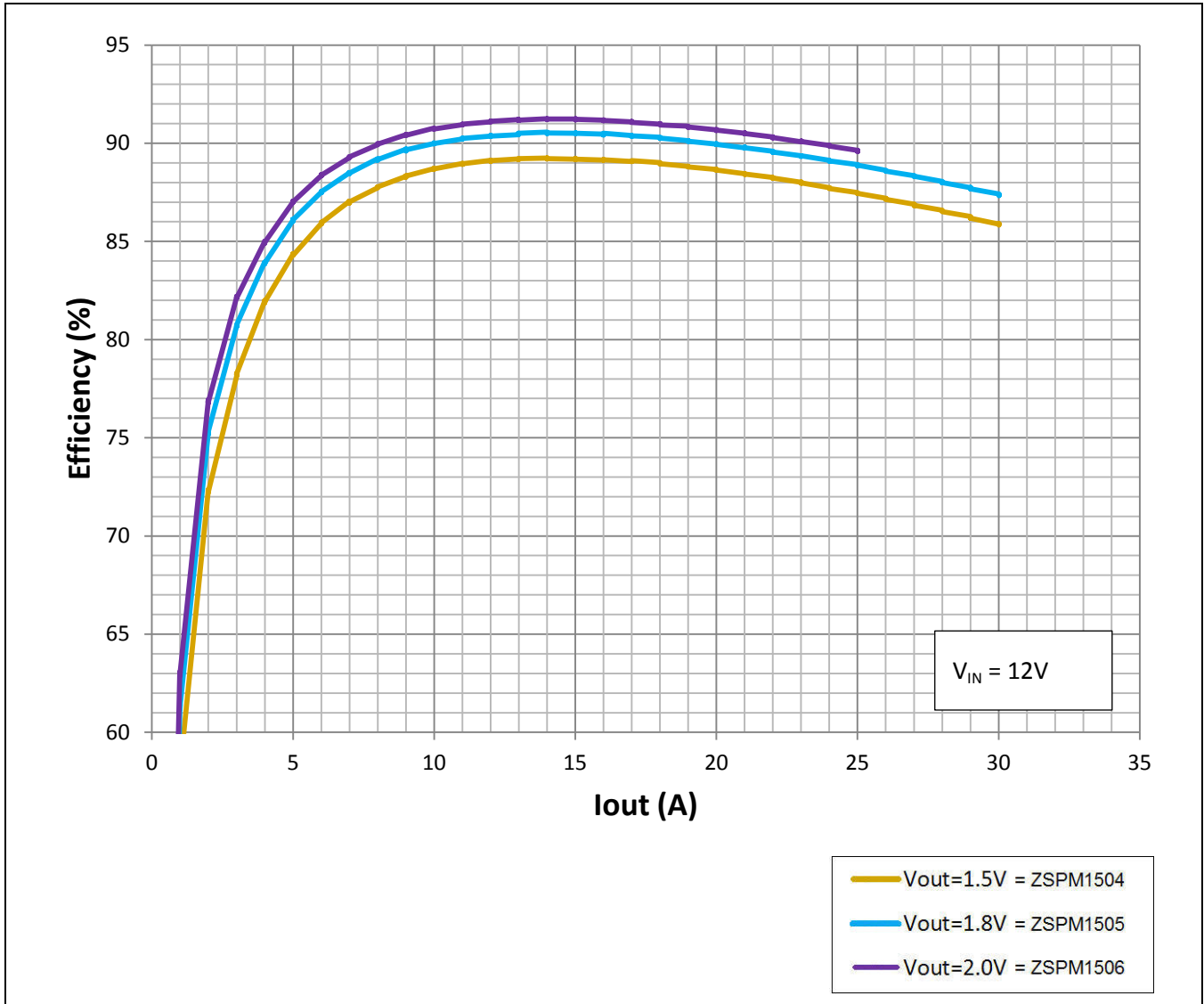

5.51. Typical Efficiency Curves – ZSPM9000 and ZSPM9060 DrMOS with ZSPM1508 and ZSPM1509

The following graph shows typical efficiency curves for the ZSPM9000 and ZSPM9060 power stages with two different ZSPM15xx controllers: the ZSPM1508 and ZSPM1509.

Figure 5.243 Typical Efficiency Curves: ZSPM9000 and ZSPM9060 DrMOS with ZSPM1508 and ZSPM1509

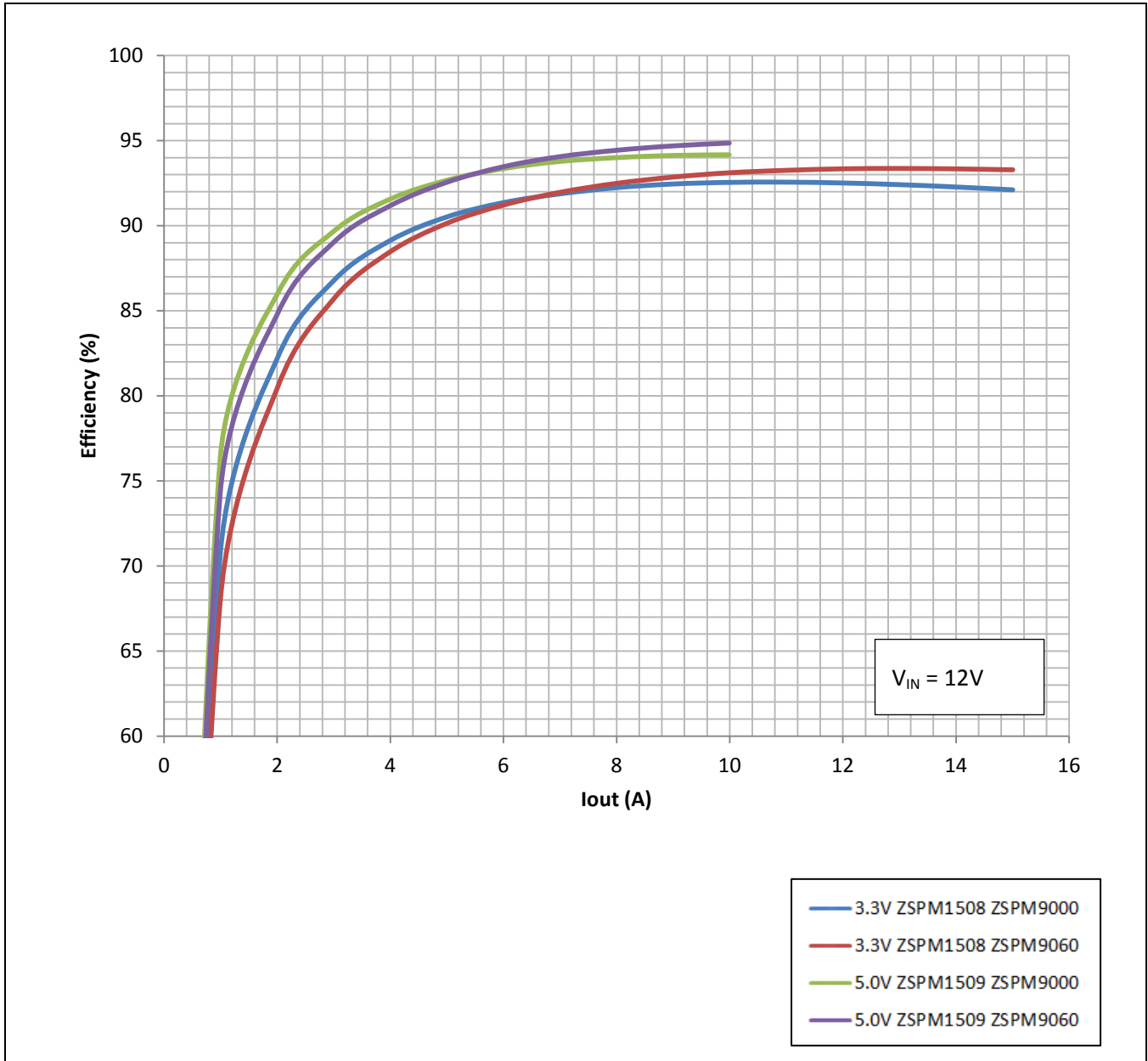

5.52. Typical Efficiency Curves – ZSPM9000 and ZSPM9060 DrMOS with ZSPM1511, ZSPM1512, and ZSPM1513

The following graph shows typical efficiency curves for the ZSPM9000 and ZSPM9060 power stages with three different ZSPM15xx controllers: the ZSPM1511, ZSPM1512, and ZSPM1513.

Figure 5.244 Typical Efficiency Curves: ZSPM9000 and ZSPM9060 DrMOS with ZSPM1511, ZSPM1512, and ZSPM1513

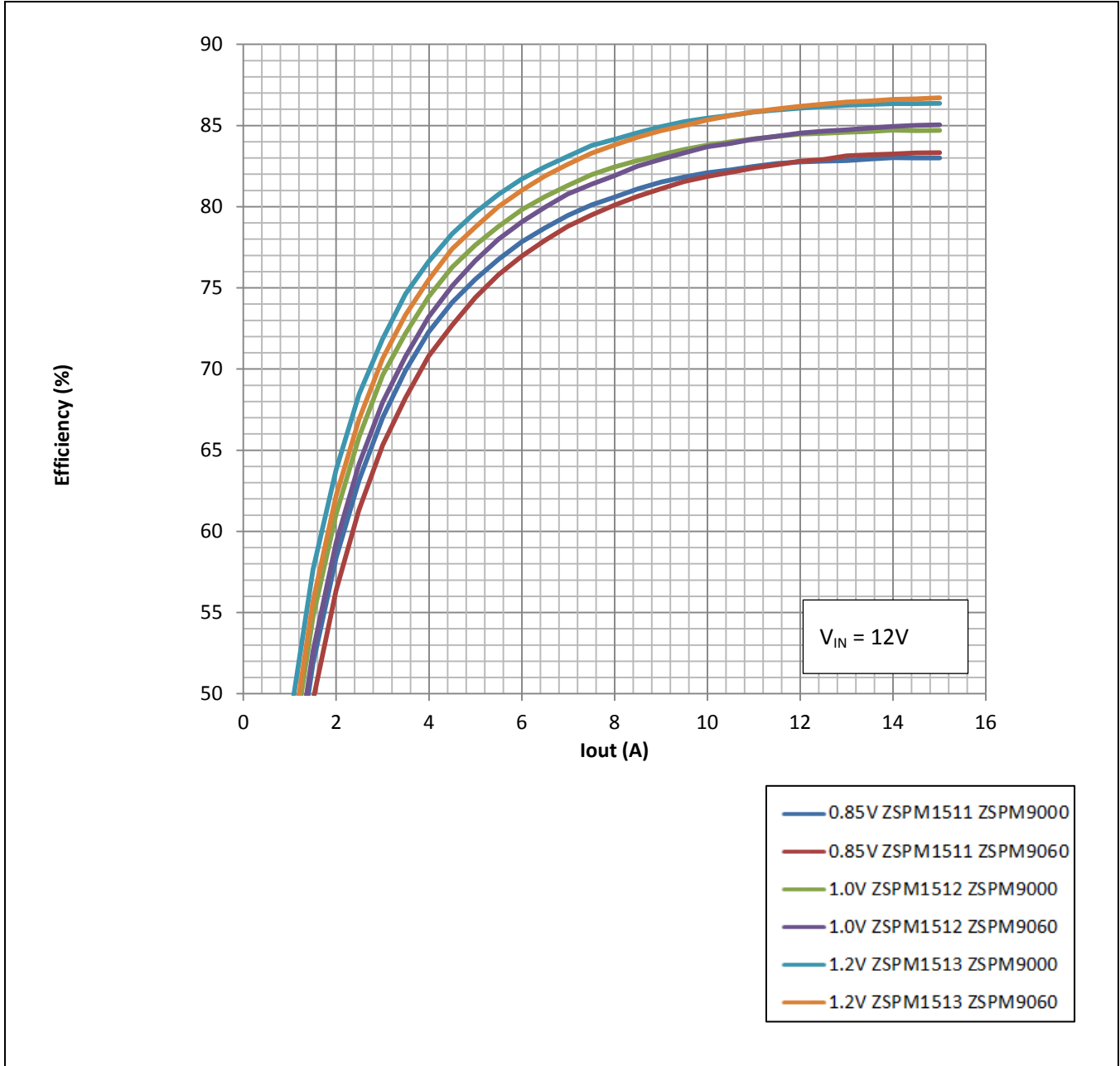

6 Mechanical Specifications

Based on JEDEC MO-220. All dimensions are in millimeters.

Figure 6.1 24-Pin QFN Package Drawing

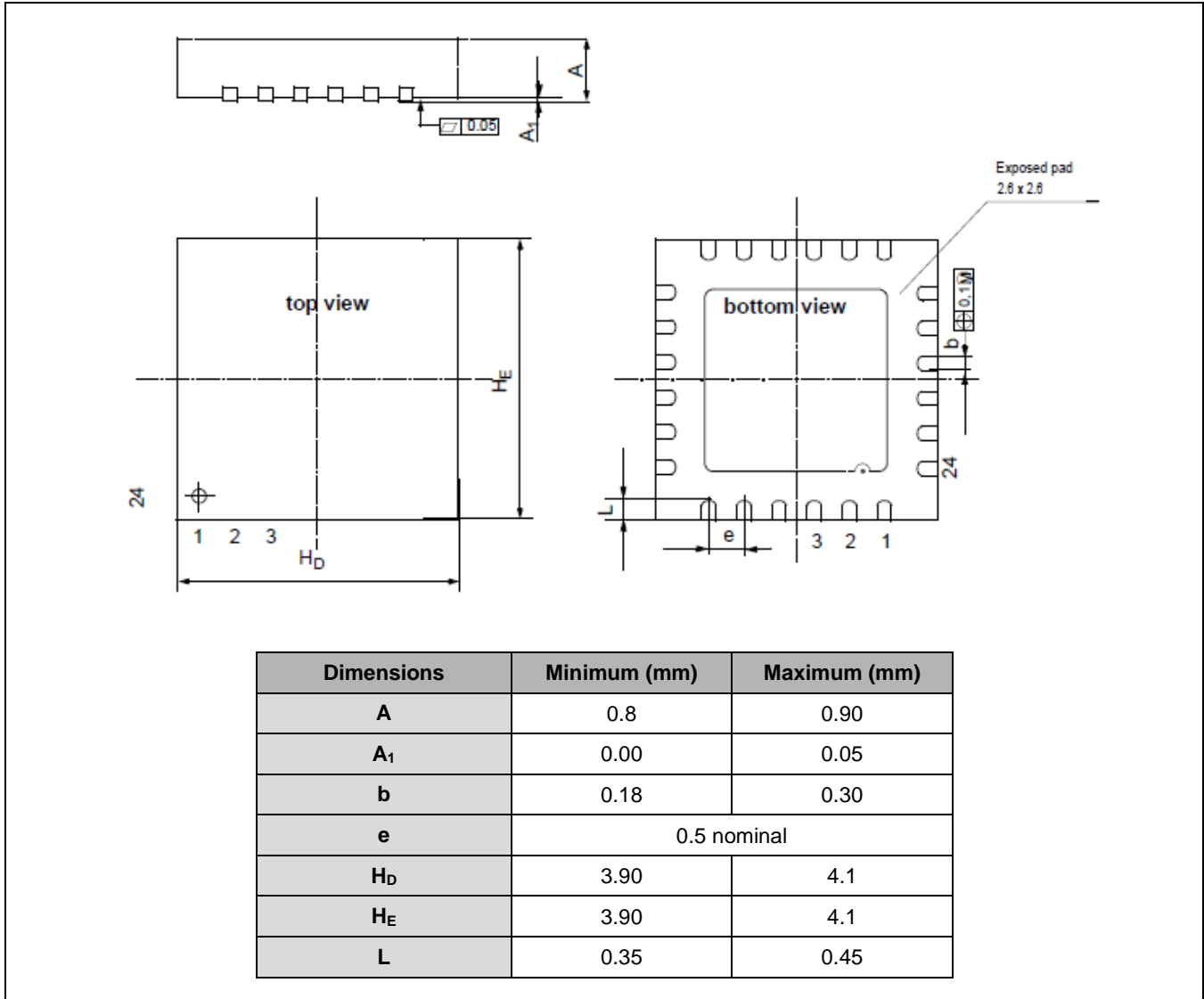

7 Ordering Information

| Product Code | Description | Package |
|---------------|---|---------|
| ZSPM1501ZA1W0 | ZSPM1501 lead-free QFN24; output voltage: 0.85V; inductance: 330nH; temperature: -40°C to +125°C | Reel |
| ZSPM1502ZA1W0 | ZSPM1502 lead-free QFN24; output voltage: 1.00V; inductance: 330nH; temperature: -40°C to +125°C | Reel |
| ZSPM1503ZA1W0 | ZSPM1503 lead-free QFN24; output voltage: 1.20V; inductance: 330nH; temperature: -40°C to +125°C | Reel |
| ZSPM1504ZA1W0 | ZSPM1504 lead-free QFN24; output voltage: 1.50V; inductance: 470nH; temperature: -40°C to +125°C | Reel |
| ZSPM1505ZA1W0 | ZSPM1505 lead-free QFN24; output voltage: 1.80V; inductance: 470nH; temperature: -40°C to +125°C | Reel |
| ZSPM1506ZA1W0 | ZSPM1506 lead-free QFN24; output voltage: 2.00V; inductance: 470nH; temperature: -40°C to +125°C | Reel |
| ZSPM1507ZA1W0 | ZSPM1507 lead-free QFN24; output voltage: 2.50V; inductance: 1000nH; temperature: -40°C to +125°C | Reel |
| ZSPM1508ZA1W0 | ZSPM1508 lead-free QFN24; output voltage: 3.30V; inductance: 2200nH; temperature: -40°C to +125°C | Reel |
| ZSPM1509ZA1W0 | ZSPM1509 lead-free QFN24; output voltage: 5.00V; inductance: 2200nH; temperature: -40°C to +125°C | Reel |
| ZSPM1511ZA1W0 | ZSPM1511 lead-free QFN24; output voltage: 0.85V; inductance: 680nH; temperature: -40°C to +125°C | Reel |
| ZSPM1512ZA1W0 | ZSPM1512 lead-free QFN24; output voltage: 1.00V; inductance: 680nH; temperature: -40°C to +125°C | Reel |
| ZSPM1513ZA1W0 | ZSPM1513 lead-free QFN24; output voltage: 1.20V; inductance: 680nH; temperature: -40°C to +125°C | Reel |

8 Related Documents

| Document |
|--------------------------------|
| ZSPM15xx Family Feature Sheet |
| ZSPM15XX-KIT01 Kit Description |

Visit the ZSPM15xx product page www.IDT.com/ZSPM15xx or contact your nearest sales office for the latest version of these documents.

9 Glossary

| Term | Description |
|-------|--|
| DCR | Equivalent DC Resistance |
| DNP | Do Not Place (Component) |
| DPWM | Digital Pulse-Width Modulator |
| DSP | Digital Signal Processing |
| FPGA | Field-Programmable Gate Array |
| HKADC | Housekeeping Analog-To-Digital Converter |
| OCP | Over-Current Protection |
| OT | Over-Temperature |
| OV | Over-Voltage |
| PID | Proportional/Integral/Derivative |
| SLC | State-Law Control™ |
| SPM | Smart Power Management |

10 Document Revision History

| Revision | Date | Description |
|----------|-------------------|--|
| 2.00 | November 24, 2014 | First release of full revision. |
| 2.10 | March 9, 2015 | Addition of ZSPM1507, ZSPM1508, and ZSPM1509 to family of products. |
| 2.20 | April 27, 2015 | Addition of ZSPM1511, ZSPM1512, and ZSPM1513 to family of products. Removal of references to Sub-cycle Response (SCR) as this is not activated in the ZSPM15xx. Addition of Table 4.10, Table 4.11, and Table 4.12 for CONFIG 1 settings for the ZSPM1507, ZSPM1508, and ZSPM1509 respectively. Correction of C9 to C10 in section 4.5. |
| | January 27, 2016 | Changed to IDT branding. |

IMPORTANT NOTICE AND DISCLAIMER

RENESAS ELECTRONICS CORPORATION AND ITS SUBSIDIARIES (“RENESAS”) PROVIDES TECHNICAL SPECIFICATIONS AND RELIABILITY DATA (INCLUDING DATASHEETS), DESIGN RESOURCES (INCLUDING REFERENCE DESIGNS), APPLICATION OR OTHER DESIGN ADVICE, WEB TOOLS, SAFETY INFORMATION, AND OTHER RESOURCES “AS IS” AND WITH ALL FAULTS, AND DISCLAIMS ALL WARRANTIES, EXPRESS OR IMPLIED, INCLUDING, WITHOUT LIMITATION, ANY IMPLIED WARRANTIES OF MERCHANTABILITY, FITNESS FOR A PARTICULAR PURPOSE, OR NON-INFRINGEMENT OF THIRD PARTY INTELLECTUAL PROPERTY RIGHTS.

These resources are intended for developers skilled in the art designing with Renesas products. You are solely responsible for (1) selecting the appropriate products for your application, (2) designing, validating, and testing your application, and (3) ensuring your application meets applicable standards, and any other safety, security, or other requirements. These resources are subject to change without notice. Renesas grants you permission to use these resources only for development of an application that uses Renesas products. Other reproduction or use of these resources is strictly prohibited. No license is granted to any other Renesas intellectual property or to any third party intellectual property. Renesas disclaims responsibility for, and you will fully indemnify Renesas and its representatives against, any claims, damages, costs, losses, or liabilities arising out of your use of these resources. Renesas' products are provided only subject to Renesas' Terms and Conditions of Sale or other applicable terms agreed to in writing. No use of any Renesas resources expands or otherwise alters any applicable warranties or warranty disclaimers for these products.

(Disclaimer Rev.1.0 Mar 2020)

Corporate Headquarters

TOYOSU FORESIA, 3-2-24 Toyosu,
Koto-ku, Tokyo 135-0061, Japan
www.renesas.com

Contact Information

For further information on a product, technology, the most up-to-date version of a document, or your nearest sales office, please visit:
www.renesas.com/contact/

Trademarks

Renesas and the Renesas logo are trademarks of Renesas Electronics Corporation. All trademarks and registered trademarks are the property of their respective owners.