

NCS2004, NCS2004A

Operational Amplifier, Rail-to-Rail, 3.5 MHz, Wide Supply

The NCS2004 operational amplifier provides rail-to-rail output operation. The output can swing within 70 mV to the positive rail and 30 mV to the negative rail. This rail-to-rail operation enables the user to make optimal use of the entire supply voltage range while taking advantage of 3.5 MHz bandwidth. The NCS2004 can operate on supply voltage as low as 2.5 V over the temperature range of -40°C to 125°C . The high bandwidth provides a slew rate of $2.4\text{ V}/\mu\text{s}$ while only consuming a typical $390\ \mu\text{A}$ of quiescent current. Likewise the NCS2004 can run on a supply voltage as high as 16 V making it ideal for a broad range of battery operated applications. Since this is a CMOS device it has high input impedance and low bias currents making it ideal for interfacing to a wide variety of signal sensors. In addition it comes in either a small SC-88A or UDFN package allowing for use in high density PCB's.

Features

- Rail-To-Rail Output
- Wide Bandwidth: 3.5 MHz
- High Slew Rate: $2.4\text{ V}/\mu\text{s}$
- Wide Power Supply Range: 2.5 V to 16 V
- Low Supply Current: $390\ \mu\text{A}$
- Low Input Bias Current: $45\ \text{pA}$
- Wide Temperature Range: -40°C to 125°C
- Small Packages: 5-Pin SC-88A and UDFN6 1.6x1.6
- These Devices are Pb-Free, Halogen Free/BFR Free and are RoHS Compliant

Applications

- Notebook Computers
- Portable Instruments



ON Semiconductor®

www.onsemi.com

MARKING DIAGRAMS



SC-88A
(SC-70-5)
SN SUFFIX
CASE 419A

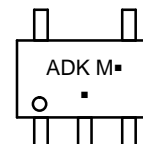

ADK = Specific Device Code

M = Date Code

▪ = Pb-Free Package

(Note: Microdot may be in either location)



UDFN6
CASE 517AP

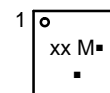

xx = Specific Device Code

AA for NCS2004

AC for NCS2004A

M = Date Code

▪ = Pb-Free Package

(Note: Microdot may be in either location)

PIN CONNECTIONS

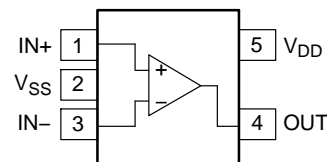

SC-88A (Top View)

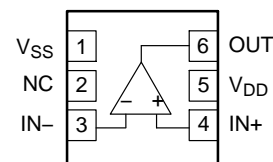

UDFN6 (Top View)

ORDERING INFORMATION

| Device | Package | Shipping† |
|--------------------------------|---------------------|-----------------------|
| NCS2004SQ3T2G | SC-88A (Pb-Free) | 3000 / Tape & Reel |
| NCS2004MUTAG, NCS2004AMUTAG | UDFN6 (Pb-Free) | 3000 / Tape & Reel |

†For information on tape and reel specifications, including part orientation and tape sizes, please refer to our Tape and Reel Packaging Specifications Brochure, BRD8011/D.

NCS2004, NCS2004A

MAXIMUM RATINGS

| Symbol | Rating | Value | Unit |
|---------------|--|-------------------------------|------|
| V_{DD} | Supply Voltage | 16.5 | V |
| V_{ID} | Input Differential Voltage | ± Supply Voltage | V |
| V_I | Input Common Mode Voltage Range | -0.2 V to ($V_{DD} + 0.2$ V) | V |
| I_I | Maximum Input Current | ± 10 | mA |
| I_O | Output Current Range | ± 100 | mA |
| | Continuous Total Power Dissipation (Note 1) | 200 | mW |
| T_J | Maximum Junction Temperature | 150 | °C |
| θ_{JA} | Thermal Resistance | 333 | °C/W |
| T_{stg} | Operating Temperature Range (free-air) | -40 to 125 | °C |
| T_{stg} | Storage Temperature | -65 to 150 | °C |
| | Mounting Temperature (Infrared or Convection – 20 sec) | 260 | °C |
| V_{ESD} | Machine Model Human Body Model | 300 2000 | V |

Stresses exceeding those listed in the Maximum Ratings table may damage the device. If any of these limits are exceeded, device functionality should not be assumed, damage may occur and reliability may be affected.

1. Continuous short circuit operation to ground at elevated ambient temperature can result in exceeding the maximum allowed junction temperature of 150°C. Output currents in excess of 45 mA over long term may adversely affect reliability. Shorting output to either V_+ or V_- will adversely affect reliability.

DC ELECTRICAL CHARACTERISTICS ($V_{DD} = 2.5$ V, 3.3 V, 5 V and ± 5 V, $T_A = 25^\circ\text{C}$, $R_L \geq 10$ k Ω unless otherwise noted)

| Parameter | Symbol | Conditions | Min | Typ | Max | Unit |
|---------------------------------|------------|--|--------------------|---|-----|------------------------------|
| Input Offset Voltage (NCS2004) | V_{IO} | $V_{IC} = V_{DD}/2$, $V_O = V_{DD}/2$, $R_L = 10$ k Ω , $R_S = 50$ Ω | | 0.5 | 5.0 | mV |
| | | $T_A = -40^\circ\text{C}$ to $+125^\circ\text{C}$ | | | 7.0 | |
| Input Offset Voltage (NCS2004A) | V_{IO} | $V_{IC} = V_{DD}/2$, $V_O = V_{DD}/2$, $R_L = 10$ k Ω , $R_S = 50$ Ω | | | 3.0 | mV |
| | | $T_A = -40^\circ\text{C}$ to $+125^\circ\text{C}$ | | | 5.0 | |
| Offset Voltage Drift | ICV_{OS} | $V_{IC} = V_{DD}/2$, $V_O = V_{DD}/2$, $R_L = 10$ k Ω , $R_S = 50$ Ω | | 2.0 | | $\mu\text{V}/^\circ\text{C}$ |
| Common Mode Rejection Ratio | CMRR | 0 V $\leq V_{IC} \leq V_{DD} - 1.35$ V, $R_S = 50$ Ω | $V_{DD} = 2.5$ V | 55 | 94 | dB |
| | | | | $T_A = -40^\circ\text{C}$ to $+125^\circ\text{C}$ | 52 | |
| | | 0 V $\leq V_{IC} \leq V_{DD} - 1.35$ V, $R_S = 50$ Ω | $V_{DD} = 5$ V | 65 | 130 | |
| | | | | $T_A = -40^\circ\text{C}$ to $+125^\circ\text{C}$ | 62 | |
| | | 0 V $\leq V_{IC} \leq V_{DD} - 1.35$ V, $R_S = 50$ Ω | $V_{DD} = \pm 5$ V | 69 | 140 | |
| | | | | $T_A = -40^\circ\text{C}$ to $+125^\circ\text{C}$ | 66 | |
| Power Supply Rejection Ratio | PSRR | $V_{DD} = 2.5$ V to 16 V, $V_{IC} = V_{DD}/2$, No Load | 70 | 135 | dB | |
| | | $T_A = -40^\circ\text{C}$ to $+125^\circ\text{C}$ | 65 | | | |
| Large Signal Voltage Gain | A_{VD} | $V_{O(pp)} = V_{DD}/2$, $R_L = 10$ k Ω | $V_{DD} = 2.5$ V | 90 | 130 | dB |
| | | | | $T_A = -40^\circ\text{C}$ to $+125^\circ\text{C}$ | 76 | |
| | | $V_{O(pp)} = V_{DD}/2$, $R_L = 10$ k Ω | $V_{DD} = 3.3$ V | 92 | 123 | |
| | | | | $T_A = -40^\circ\text{C}$ to $+125^\circ\text{C}$ | 76 | |
| | | $V_{O(pp)} = V_{DD}/2$, $R_L = 10$ k Ω | $V_{DD} = 5$ V | 95 | 127 | |
| | | | | $T_A = -40^\circ\text{C}$ to $+125^\circ\text{C}$ | 86 | |
| | | $V_{O(pp)} = V_{DD}/2$, $R_L = 10$ k Ω | $V_{DD} = \pm 5$ V | 95 | 130 | |
| | | | | $T_A = -40^\circ\text{C}$ to $+125^\circ\text{C}$ | 90 | |

NCS2004, NCS2004A

DC ELECTRICAL CHARACTERISTICS ($V_{DD} = 2.5\text{ V}, 3.3\text{ V}, 5\text{ V}$ and $\pm 5\text{ V}$, $T_A = 25^\circ\text{C}$, $R_L \geq 10\text{ k}\Omega$ unless otherwise noted)

| Parameter | Symbol | Conditions | | Min | Typ | Max | Unit |
|-------------------------------|------------|---|---------------------------|------|------|------|------------|
| Input Bias Current | I_B | $V_{DD} = 5\text{ V}, V_{IC} = V_{DD}/2, V_O = V_{DD}/2,$ $R_S = 50\ \Omega$ | $T_A = 25^\circ\text{C}$ | | 45 | 150 | pA |
| | | | $T_A = 125^\circ\text{C}$ | | | 1000 | |
| Input Offset Current | I_{IO} | $V_{DD} = 5\text{ V}, V_{IC} = V_{DD}/2, V_O = V_{DD}/2,$ $R_S = 50\ \Omega$ | $T_A = 25^\circ\text{C}$ | | 45 | 150 | pA |
| | | | $T_A = 125^\circ\text{C}$ | | | 1000 | |
| Differential Input Resistance | $r_{i(d)}$ | | | | 1000 | | G Ω |
| Common-mode Input Capacitance | C_{IC} | $f = 21\text{ kHz}$ | | | 8.0 | | pF |
| Output Swing (High-level) | V_{OH} | $V_{IC} = V_{DD}/2, I_{OH} = -1\text{ mA}$ | $V_{DD} = 2.5\text{ V}$ | 2.35 | 2.43 | | V |
| | | $T_A = -40^\circ\text{C}$ to $+125^\circ\text{C}$ | | 2.28 | | | |
| | | $V_{IC} = V_{DD}/2, I_{OH} = -1\text{ mA}$ | $V_{DD} = 3.3\text{ V}$ | 3.15 | 3.21 | | |
| | | $T_A = -40^\circ\text{C}$ to $+125^\circ\text{C}$ | | 3.00 | | | |
| | | $V_{IC} = V_{DD}/2, I_{OH} = -1\text{ mA}$ | $V_{DD} = 5\text{ V}$ | 4.8 | 4.93 | | |
| | | $T_A = -40^\circ\text{C}$ to $+125^\circ\text{C}$ | | 4.75 | | | |
| | | $V_{IC} = V_{DD}/2, I_{OH} = -1\text{ mA}$ | $V_{DD} = \pm 5\text{ V}$ | 4.92 | 4.96 | | |
| | | $T_A = -40^\circ\text{C}$ to $+125^\circ\text{C}$ | | 4.9 | | | |
| | | $V_{IC} = V_{DD}/2, I_{OH} = -5\text{ mA}$ | $V_{DD} = 2.5\text{ V}$ | 1.7 | 2.14 | | V |
| | | $T_A = -40^\circ\text{C}$ to $+125^\circ\text{C}$ | | 1.5 | | | |
| | | $V_{IC} = V_{DD}/2, I_{OH} = -5\text{ mA}$ | $V_{DD} = 3.3\text{ V}$ | 2.5 | 2.89 | | |
| | | $T_A = -40^\circ\text{C}$ to $+125^\circ\text{C}$ | | 2.1 | | | |
| | | $V_{IC} = V_{DD}/2, I_{OH} = -5\text{ mA}$ | $V_{DD} = 5\text{ V}$ | 4.5 | 4.68 | | |
| | | $T_A = -40^\circ\text{C}$ to $+125^\circ\text{C}$ | | 4.35 | | | |
| | | $V_{IC} = V_{DD}/2, I_{OH} = -5\text{ mA}$ | $V_{DD} = \pm 5\text{ V}$ | 4.7 | 4.78 | | |
| | | $T_A = -40^\circ\text{C}$ to $+125^\circ\text{C}$ | | 4.65 | | | |
| Output Swing (Low-level) | V_{OL} | $V_{IC} = V_{DD}/2, I_{OL} = -1\text{ mA}$ | $V_{DD} = 2.5\text{ V}$ | | 0.03 | 0.15 | V |
| | | $T_A = -40^\circ\text{C}$ to $+125^\circ\text{C}$ | | | | 0.22 | |
| | | $V_{IC} = V_{DD}/2, I_{OL} = -1\text{ mA}$ | $V_{DD} = 3.3\text{ V}$ | | 0.03 | 0.15 | |
| | | $T_A = -40^\circ\text{C}$ to $+125^\circ\text{C}$ | | | | 0.22 | |
| | | $V_{IC} = V_{DD}/2, I_{OL} = -1\text{ mA}$ | $V_{DD} = 5\text{ V}$ | | 0.03 | 0.1 | |
| | | $T_A = -40^\circ\text{C}$ to $+125^\circ\text{C}$ | | | | 0.15 | |
| | | $V_{IC} = V_{DD}/2, I_{OL} = -1\text{ mA}$ | $V_{DD} = \pm 5\text{ V}$ | | 0.05 | 0.08 | |
| | | $T_A = -40^\circ\text{C}$ to $+125^\circ\text{C}$ | | | | 0.1 | |
| | | $V_{IC} = V_{DD}/2, I_{OL} = -5\text{ mA}$ | $V_{DD} = 2.5\text{ V}$ | | 0.15 | 0.7 | V |
| | | $T_A = -40^\circ\text{C}$ to $+125^\circ\text{C}$ | | | | 1.1 | |
| | | $V_{IC} = V_{DD}/2, I_{OL} = -5\text{ mA}$ | $V_{DD} = 3.3\text{ V}$ | | 0.13 | 0.7 | |
| | | $T_A = -40^\circ\text{C}$ to $+125^\circ\text{C}$ | | | | 1.1 | |
| | | $V_{IC} = V_{DD}/2, I_{OL} = -5\text{ mA}$ | $V_{DD} = 5\text{ V}$ | | 0.13 | 0.4 | |
| | | $T_A = -40^\circ\text{C}$ to $+125^\circ\text{C}$ | | | | 0.5 | |
| | | $V_{IC} = V_{DD}/2, I_{OL} = -5\text{ mA}$ | $V_{DD} = \pm 5\text{ V}$ | | 0.16 | 0.3 | |
| | | $T_A = -40^\circ\text{C}$ to $+125^\circ\text{C}$ | | | | 0.35 | |

NCS2004, NCS2004A

DC ELECTRICAL CHARACTERISTICS ($V_{DD} = 2.5\text{ V}, 3.3\text{ V}, 5\text{ V}$ and $\pm 5\text{ V}$, $T_A = 25^\circ\text{C}$, $R_L \geq 10\text{ k}\Omega$ unless otherwise noted)

| Parameter | Symbol | Conditions | Min | Typ | Max | Unit | |
|--------------------------------|----------|---|-------------------------|-----|------|------|---------------|
| Output Current | I_O | $V_O = 0.5\text{ V}$ from rail, $V_{DD} = 2.5\text{ V}$ | Positive rail | | 4.0 | | mA |
| | | | Negative rail | | 5.0 | | |
| | | $V_O = 0.5\text{ V}$ from rail, $V_{DD} = 5\text{ V}$ | Positive rail | | 7.0 | | |
| | | | Negative rail | | 8.0 | | |
| | | $V_O = 0.5\text{ V}$ from rail, $V_{DD} = 10\text{ V}$ | Positive rail | | 13 | | |
| | | | Negative rail | | 12 | | |
| Power Supply Quiescent Current | I_{DD} | $V_O = V_{DD}/2$ | $V_{DD} = 2.5\text{ V}$ | | 380 | 560 | μA |
| | | | $V_{DD} = 3.3\text{ V}$ | | 385 | 620 | |
| | | | $V_{DD} = 5\text{ V}$ | | 390 | 660 | |
| | | | $V_{DD} = 10\text{ V}$ | | 400 | 800 | |
| | | $T_A = -40^\circ\text{C}$ to $+125^\circ\text{C}$ | | | 1000 | | |

AC ELECTRICAL CHARACTERISTICS ($V_{DD} = 2.5\text{ V}, 5\text{ V}$, & $\pm 5\text{ V}$, $T_A = 25^\circ\text{C}$, and $R_L \geq 10\text{ k}\Omega$ unless otherwise noted)

| Parameter | Symbol | Conditions | Min | Typ | Max | Unit | |
|---|------------|--|--|---|-------|------------------------------|------------------------|
| Unity Gain Bandwidth | UGBW | $R_L = 2\text{ k}\Omega$, $C_L = 10\text{ pF}$ | $V_{DD} = 2.5\text{ V}$ | | 3.2 | | MHz |
| | | | $V_{DD} = 5\text{ V}$ to 10 V | | 3.5 | | |
| Slew Rate at Unity Gain | SR | $V_{O(pp)} = V_{DD}/2$, $R_L = 10\text{ k}\Omega$, $C_L = 50\text{ pF}$ | $V_{DD} = 2.5\text{ V}$ | | 1.35 | 2.0 | $\text{V}/\mu\text{S}$ |
| | | | | $T_A = -40^\circ\text{C}$ to $+125^\circ\text{C}$ | | 1 | |
| | | $V_{O(pp)} = V_{DD}/2$, $R_L = 10\text{ k}\Omega$, $C_L = 50\text{ pF}$ | $V_{DD} = 5\text{ V}$ | | 1.45 | 2.3 | |
| | | | | $T_A = -40^\circ\text{C}$ to $+125^\circ\text{C}$ | | 1.2 | |
| | | $V_{O(pp)} = V_{DD}/2$, $R_L = 10\text{ k}\Omega$, $C_L = 50\text{ pF}$ | $V_{DD} = \pm 5\text{ V}$ | | 1.8 | 2.6 | |
| $T_A = -40^\circ\text{C}$ to $+125^\circ\text{C}$ | | 1.3 | | | | | |
| Phase Margin | θ_m | $R_L = 2\text{ k}\Omega$, $C_L = 10\text{ pF}$ | | 45 | | $^\circ$ | |
| Gain Margin | | $R_L = 2\text{ k}\Omega$, $C_L = 10\text{ pF}$ | | 14 | | dB | |
| Settling Time to 0.1% | t_S | $V\text{-step}(pp) = 1\text{ V}$, $AV = -1$, $R_L = 2\text{ k}\Omega$, $C_L = 10\text{ pF}$ | $V_{DD} = 2.5\text{ V}$ | | 2.9 | | μS |
| | | $V\text{-step}(pp) = 1\text{ V}$, $AV = -1$, $R_L = 2\text{ k}\Omega$, $C_L = 68\text{ pF}$ | $V_{DD} = 5\text{ V}$, $\pm 5\text{ V}$ | | 2.0 | | |
| Total Harmonic Distortion plus Noise | THD+N | $V_{DD} = 2.5\text{ V}$, $V_{O(pp)} = V_{DD}/2$, $R_L = 2\text{ k}\Omega$, $f = 10\text{ kHz}$ | $AV = 1$ | | 0.004 | | % |
| | | | $AV = 10$ | | 0.04 | | |
| | | | $AV = 100$ | | 0.3 | | |
| | | $V_{DD} = 5\text{ V}$, $\pm 5\text{ V}$, $V_{O(pp)} = V_{DD}/2$, $R_L = 2\text{ k}\Omega$, $f = 10\text{ kHz}$ | $AV = 1$ | | 0.004 | | |
| | | | $AV = 10$ | | 0.04 | | |
| | | | $AV = 100$ | | 0.03 | | |
| Input-Referred Voltage Noise | e_n | $f = 1\text{ kHz}$ | | 30 | | $\text{nV}/\sqrt{\text{Hz}}$ | |
| | | $f = 10\text{ kHz}$ | | 20 | | | |
| Input-Referred Current Noise | i_n | $f = 1\text{ kHz}$ | | 0.6 | | $\text{fA}/\sqrt{\text{Hz}}$ | |

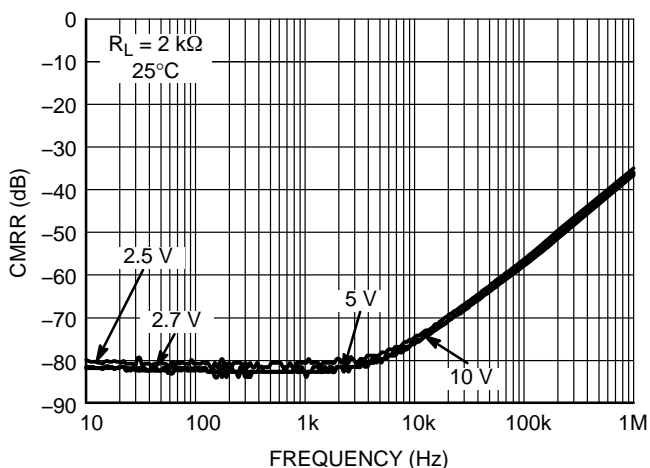

Figure 1. CMRR vs. Frequency

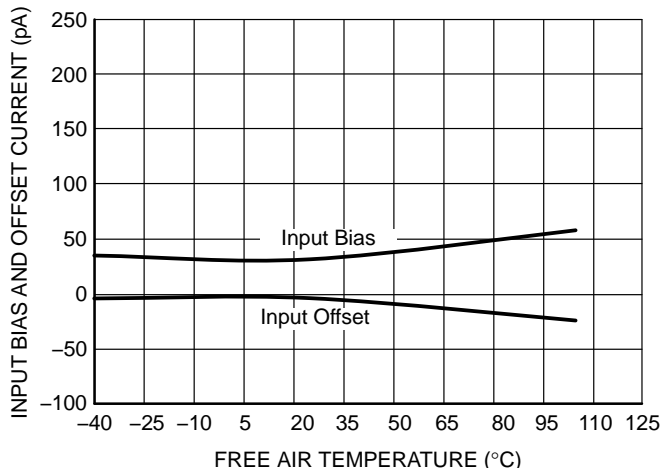

Figure 2. Input Bias and Offset Current vs. Temperature

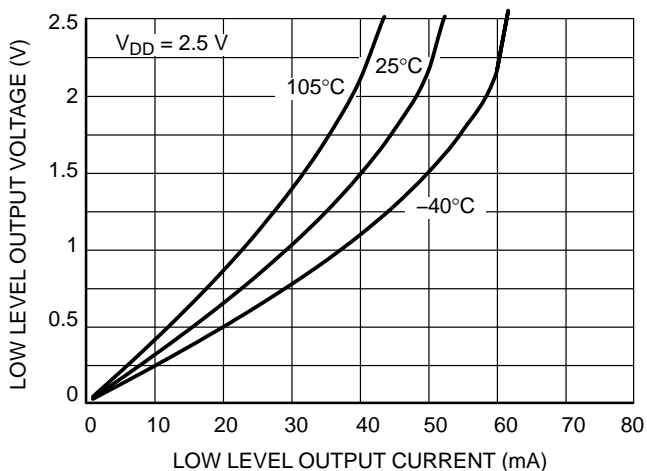

Figure 3. 2.5 V V_{OL} vs. I_{out}

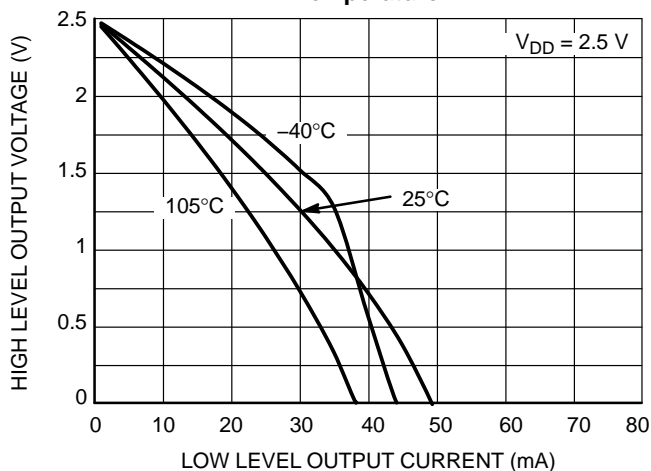

Figure 4. 2.5 V V_{OH} vs. I_{out}

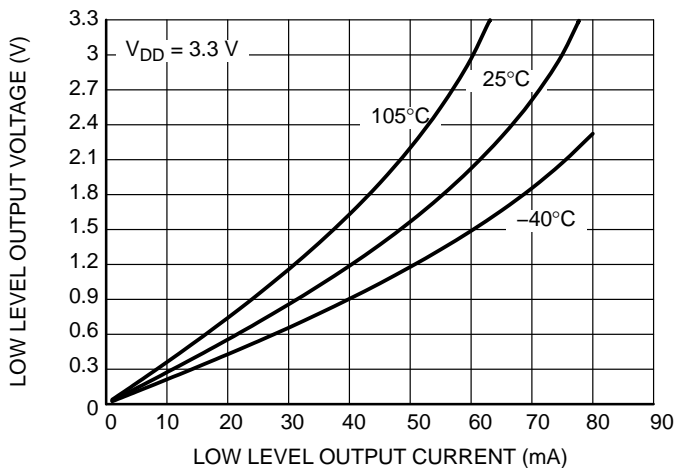

Figure 5. 3.3 V V_{OL} vs. I_{out}

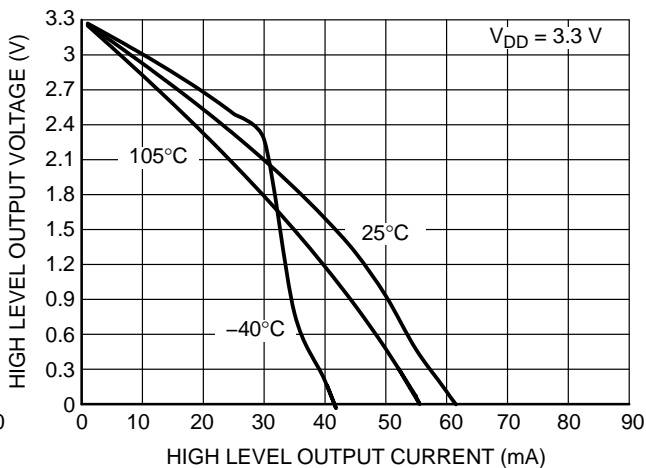

Figure 6. 3.3 V V_{OH} vs. I_{out}

NCS2004, NCS2004A

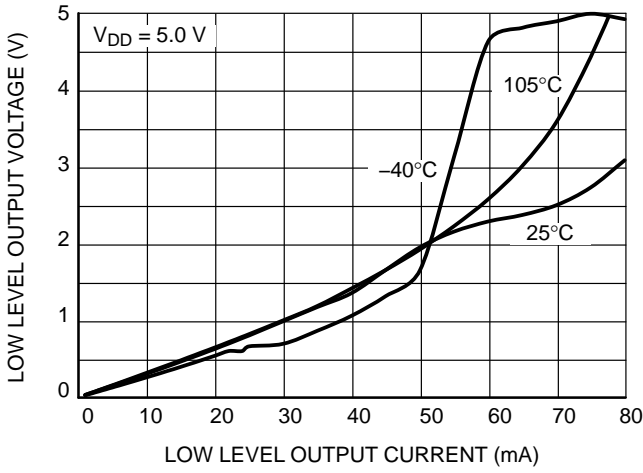

Figure 7. V_{OL} vs. I_{out}

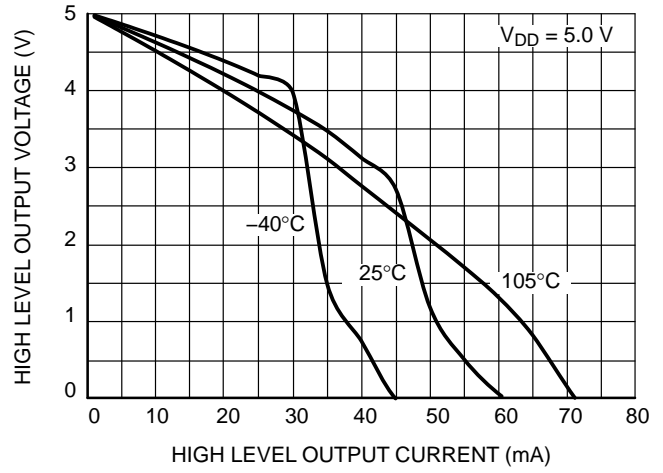

Figure 8. V_{OH} vs. I_{out}

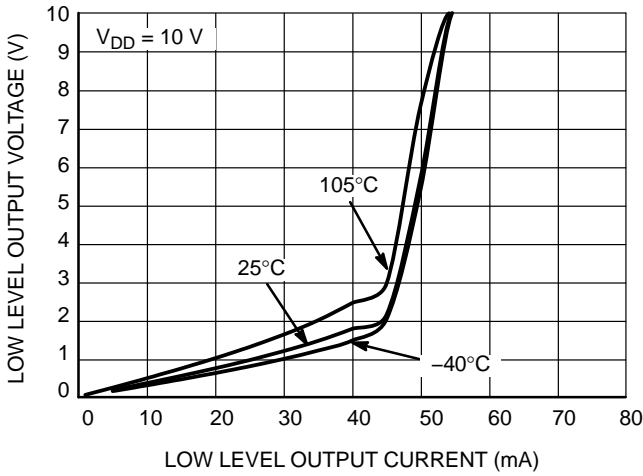

Figure 9. 10 V V_{OL} vs. I_{out}

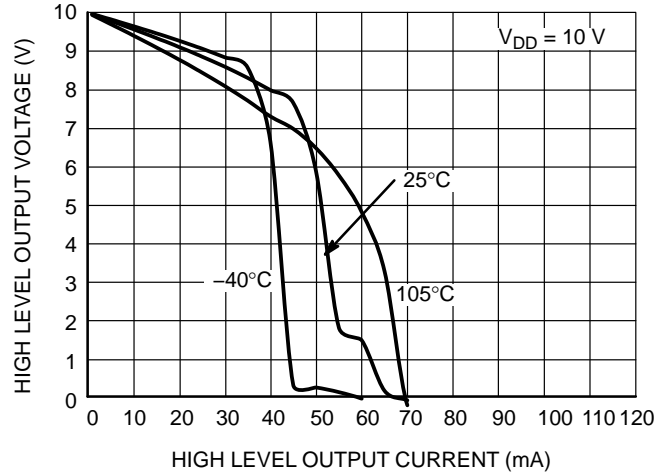

Figure 10. 10 V V_{OH} vs. I_{out}

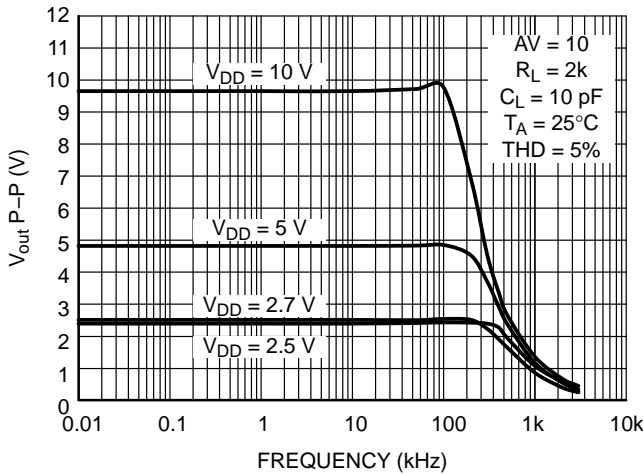

Figure 11. Peak-to-Peak Output vs. Supply vs. Frequency

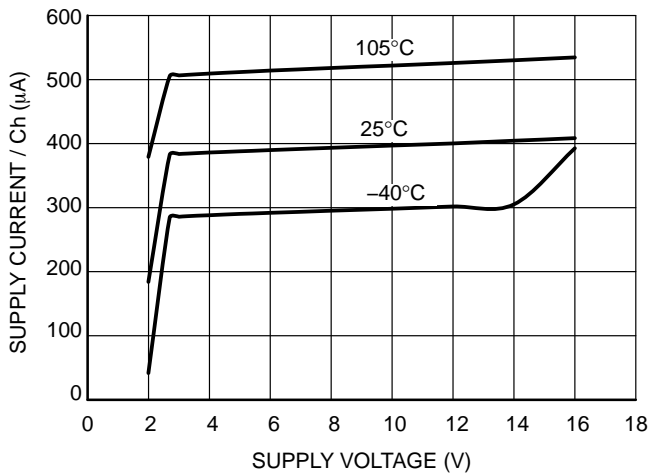

Figure 12. Supply Current vs. Supply Voltage

NCS2004, NCS2004A

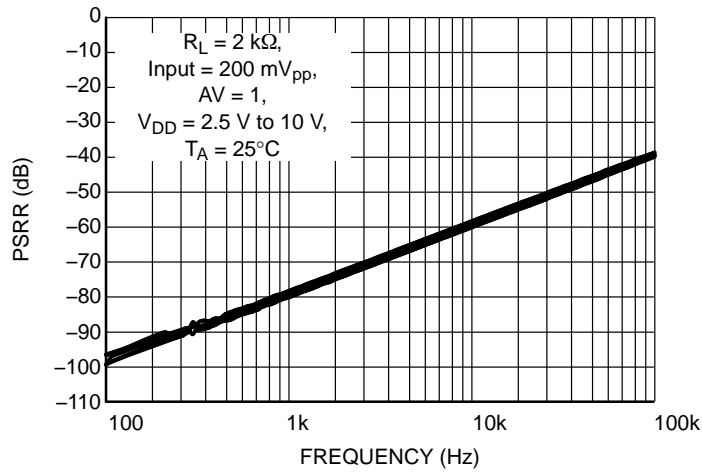

Figure 13. PSRR vs. Frequency

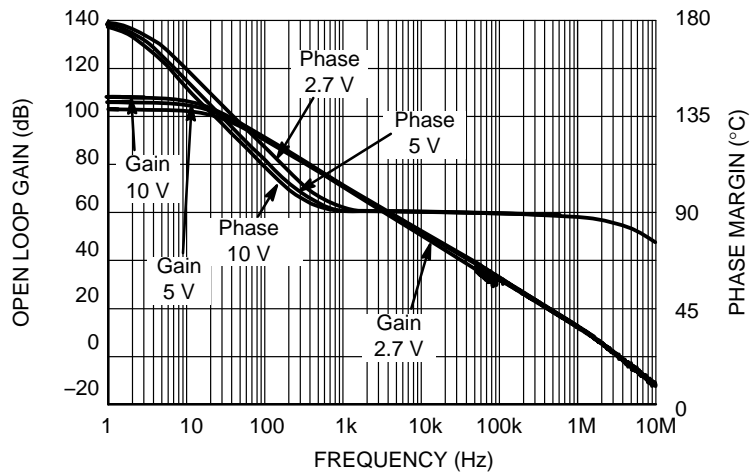

Figure 14. Open Loop Gain and Phase vs. Frequency

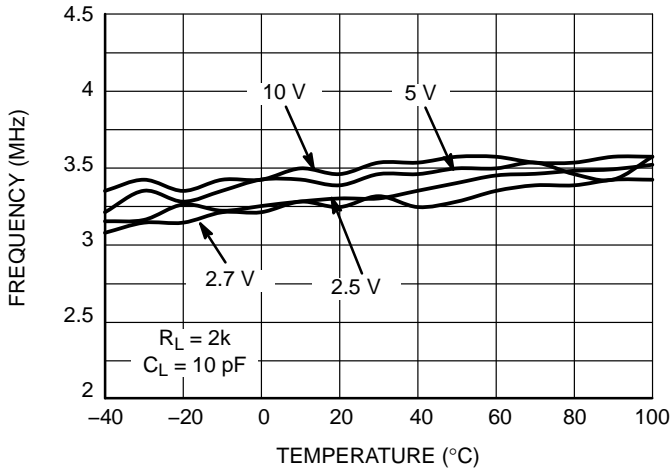

Figure 15. Gain Bandwidth Product vs. Temperature

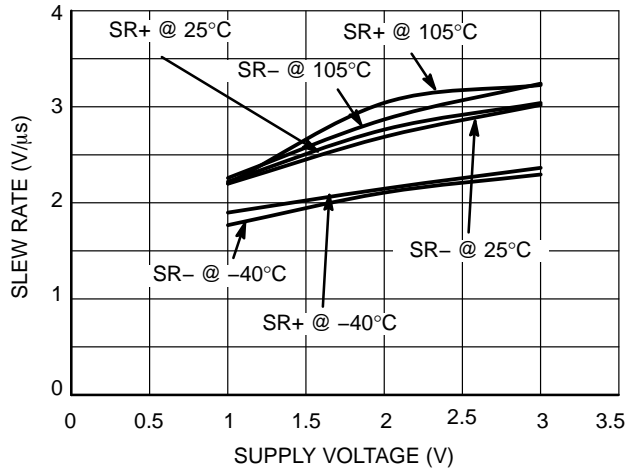

Figure 16. Slew Rate vs. Supply Voltage

NCS2004, NCS2004A

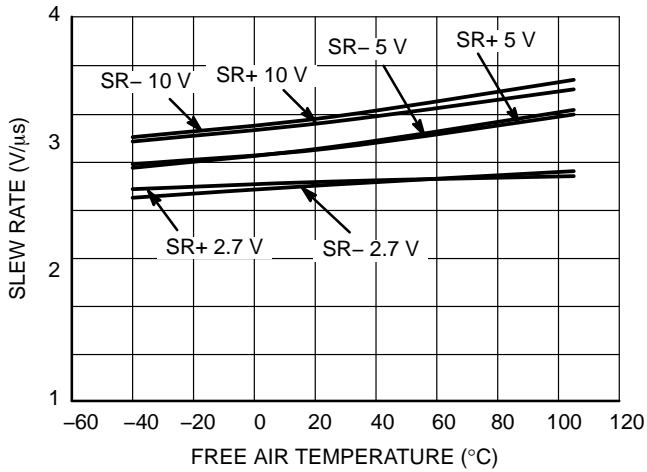

Figure 17. Slew Rate vs. Temperature

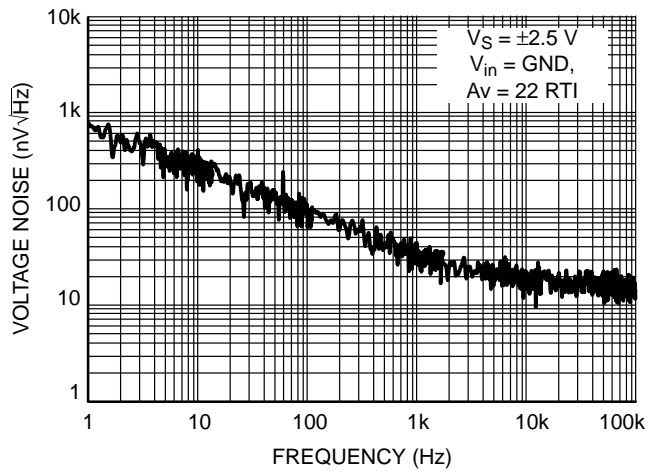

Figure 18. Voltage Noise vs. Frequency

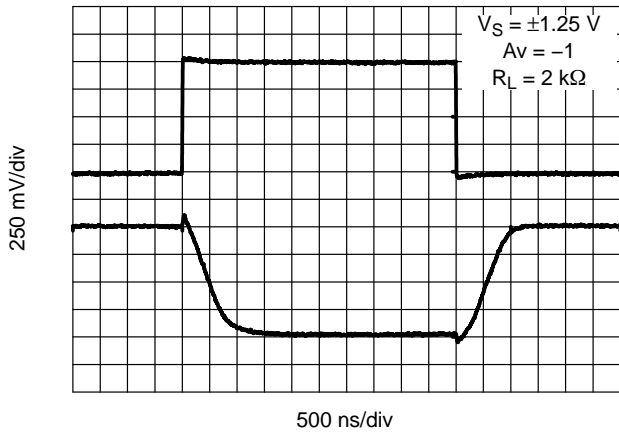

Figure 19. 2.5 V Inverting Large Signal Pulse Response

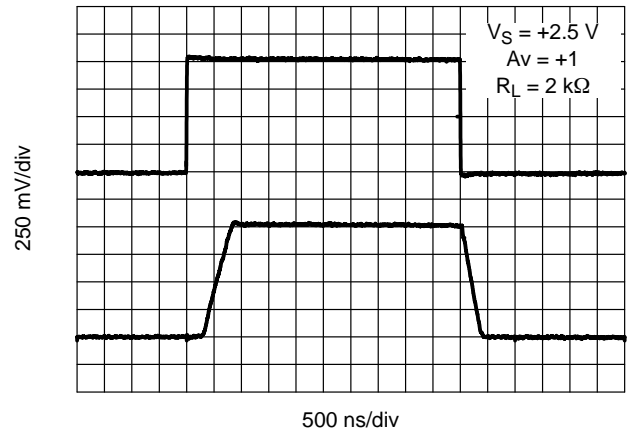

Figure 20. 2.5 V Non-Inverting Large Signal Pulse Response

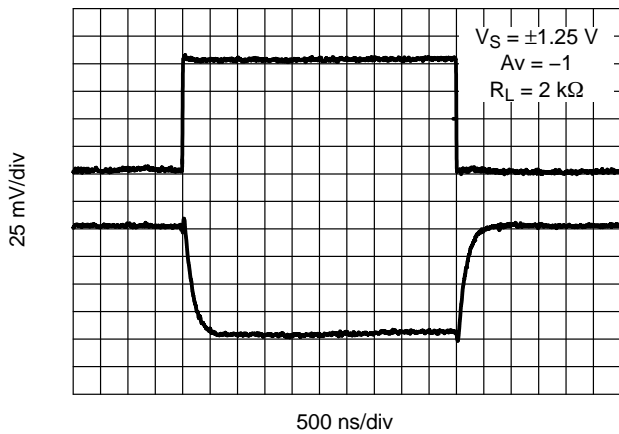

Figure 21. 2.5 V Inverting Small Signal Pulse Response

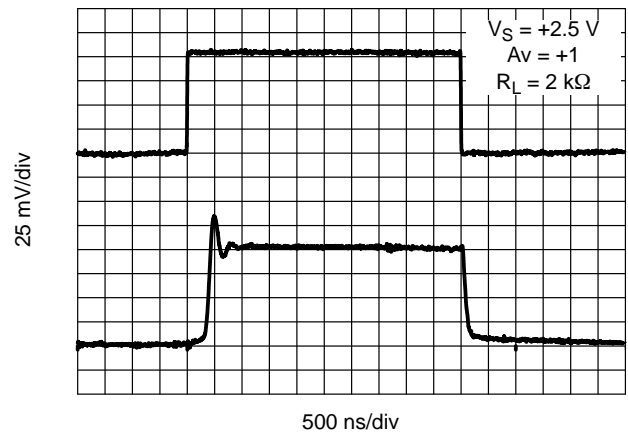
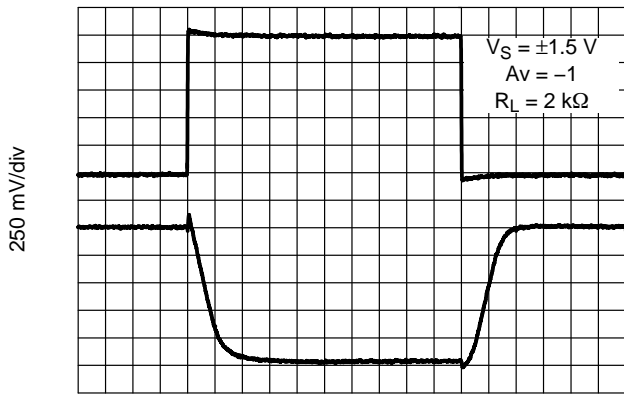

Figure 22. 2.5 V Non-Inverting Small Signal Pulse Response

NCS2004, NCS2004A



500 ns/div

Figure 23. 3 V Inverting Large Signal Pulse Response



500 ns/div

Figure 24. 3 V Non-Inverting Large Signal Pulse Response

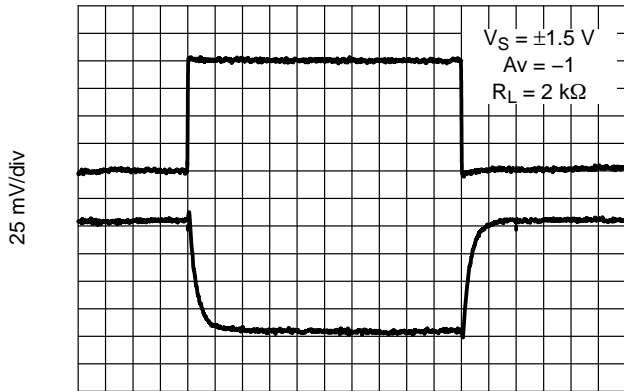

500 ns/div

Figure 25. 3 V Inverting Small Signal Pulse Response

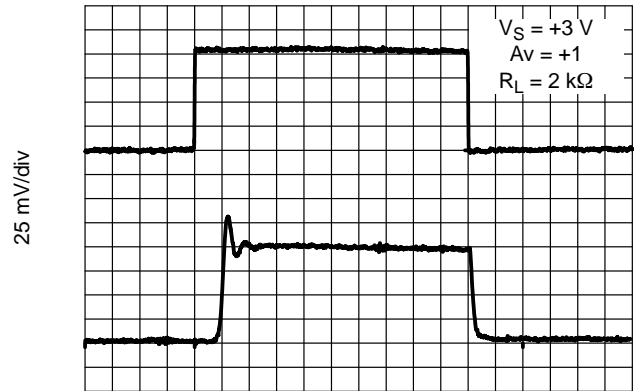

500 ns/div

Figure 26. 3 V Non-Inverting Small Signal Pulse Response

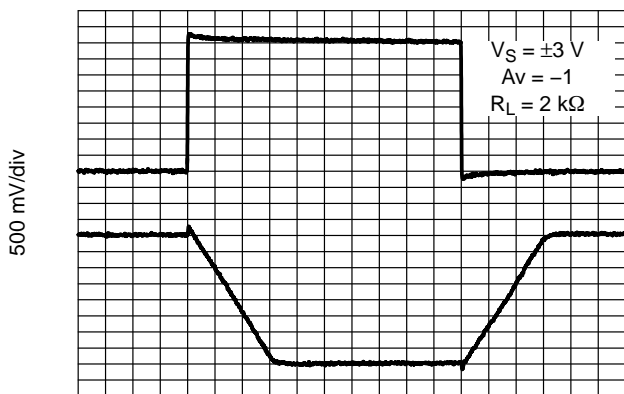

500 ns/div

Figure 27. 6 V Inverting Large Signal Pulse Response

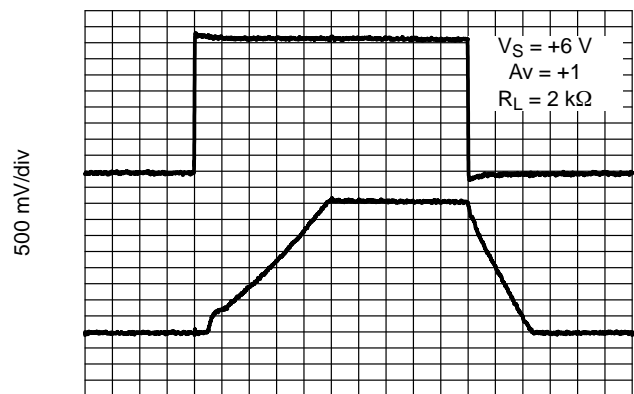

500 ns/div

Figure 28. 6 V Non-Inverting Large Signal Pulse Response

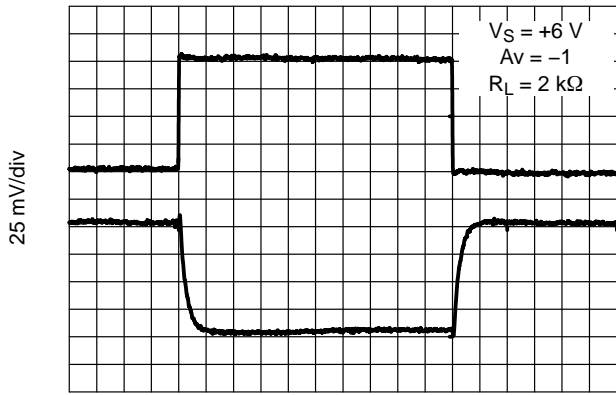

Figure 29. 6 V Inverting Small Signal Pulse Response

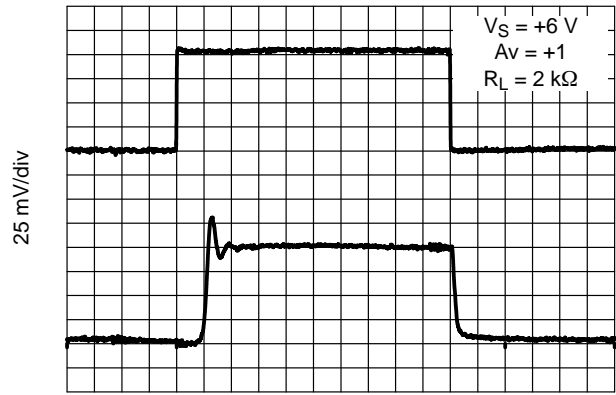

Figure 30. 6 V Non-Inverting Small Signal Pulse Response

APPLICATIONS

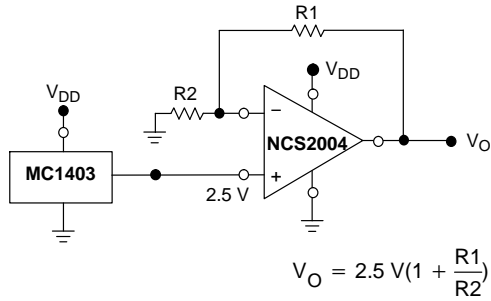

Figure 31. Voltage Reference

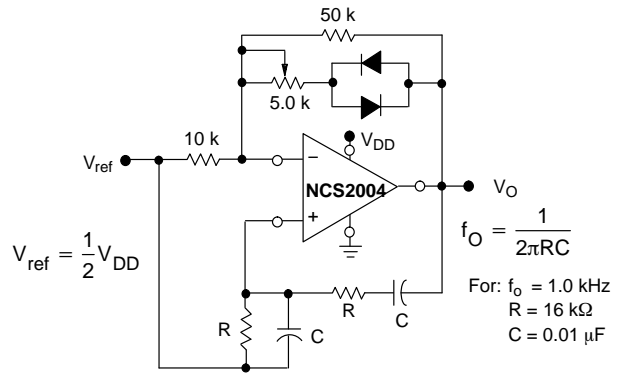

Figure 32. Wien Bridge Oscillator

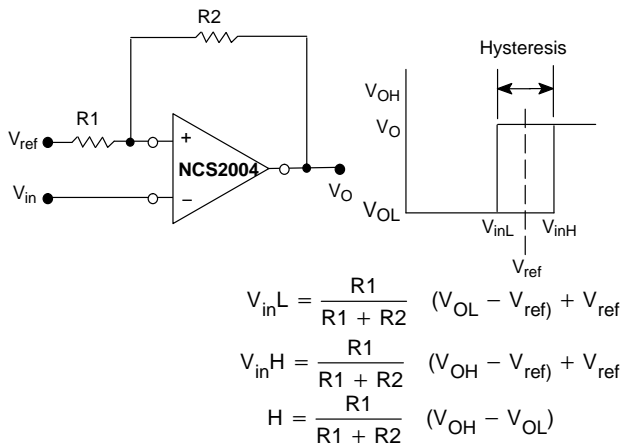

Figure 33. Comparator with Hysteresis

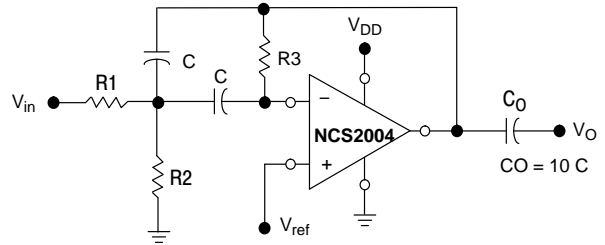

Figure 34. Multiple Feedback Bandpass Filter

MECHANICAL CASE OUTLINE PACKAGE DIMENSIONS



SCALE 2:1

SC-88A (SC-70-5/SOT-353) CASE 419A-02 ISSUE M

DATE 11 APR 2023

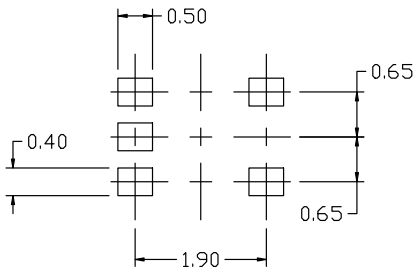
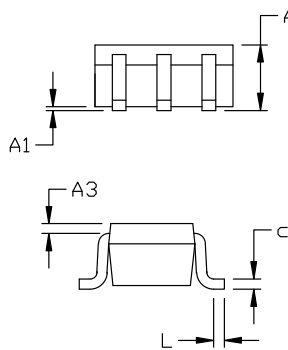
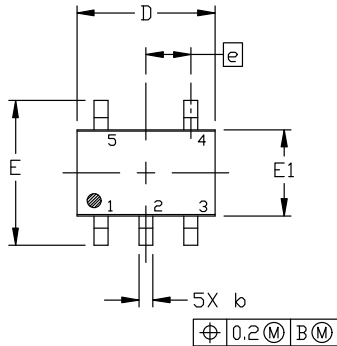

RECOMMENDED MOUNTING FOOTPRINT

* For additional information on our Pb-Free strategy and soldering details, please download the ON Semiconductor Soldering and Mounting Techniques Reference Manual, SOLDERM/D.

NOTES:

1. DIMENSIONING AND TOLERANCING PER ANSI Y14.5M, 1982.
2. CONTROLLING DIMENSION: MILLIMETERS
3. 419A-01 OBSOLETE. NEW STANDARD 419A-02
4. DIMENSIONS D AND E1 DO NOT INCLUDE MOLD FLASH, PROTRUSIONS, OR GATE BURRS. MOLD FLASH, PROTRUSIONS, OR GATE BURRS SHALL NOT EXCEED 0.1016MM PER SIDE.

| DIM | MILLIMETERS | | |
|-----|-------------|------|------|
| | MIN. | NOM. | MAX. |
| A | 0.80 | 0.95 | 1.10 |
| A1 | --- | --- | 0.10 |
| A3 | 0.20 REF | | |
| b | 0.10 | 0.20 | 0.30 |
| c | 0.10 | --- | 0.25 |
| D | 1.80 | 2.00 | 2.20 |
| E | 2.00 | 2.10 | 2.20 |
| E1 | 1.15 | 1.25 | 1.35 |
| e | 0.65 BSC | | |
| L | 0.10 | 0.15 | 0.30 |

GENERIC MARKING DIAGRAM*

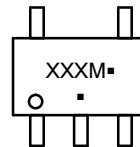

*This information is generic. Please refer to device data sheet for actual part marking. Pb-Free indicator, "G" or microdot "▪", may or may not be present. Some products may not follow the Generic Marking.

XXX = Specific Device Code

M = Date Code

▪ = Pb-Free Package

(Note: Microdot may be in either location)

STYLE 1:

- PIN 1. BASE
- EMITTER
- BASE
- COLLECTOR
- COLLECTOR

STYLE 2:

- PIN 1. ANODE
- EMITTER
- BASE
- COLLECTOR
- CATHODE

STYLE 3:

- PIN 1. ANODE 1
- N/C
- ANODE 2
- CATHODE 2
- CATHODE 1

STYLE 4:

- PIN 1. SOURCE 1
- DRAIN 1/2
- SOURCE 1
- GATE 1
- GATE 2

STYLE 5:

- PIN 1. CATHODE
- COMMON ANODE
- CATHODE 2
- CATHODE 3
- CATHODE 4

STYLE 6:

- PIN 1. EMITTER 2
- BASE 2
- EMITTER 1
- COLLECTOR
- COLLECTOR 2/BASE 1

STYLE 7:

- PIN 1. BASE
- EMITTER
- BASE
- COLLECTOR
- COLLECTOR

STYLE 8:

- PIN 1. CATHODE
- COLLECTOR
- N/C
- BASE
- EMITTER

STYLE 9:

- PIN 1. ANODE
- CATHODE
- ANODE
- ANODE
- ANODE

Note: Please refer to datasheet for style callout. If style type is not called out in the datasheet refer to the device datasheet pinout or pin assignment.

| | | |
|-------------------------|---------------------------------|---|
| DOCUMENT NUMBER: | 98ASB42984B | Electronic versions are uncontrolled except when accessed directly from the Document Repository. Printed versions are uncontrolled except when stamped "CONTROLLED COPY" in red. |
| DESCRIPTION: | SC-88A (SC-70-5/SOT-353) | PAGE 1 OF 1 |

onsemi and ONSEMI are trademarks of Semiconductor Components Industries, LLC dba onsemi or its subsidiaries in the United States and/or other countries. onsemi reserves the right to make changes without further notice to any products herein. onsemi makes no warranty, representation or guarantee regarding the suitability of its products for any particular purpose, nor does onsemi assume any liability arising out of the application or use of any product or circuit, and specifically disclaims any and all liability, including without limitation special, consequential or incidental damages. onsemi does not convey any license under its patent rights nor the rights of others.



UDFN6 1.6x1.6, 0.5P CASE 517AP ISSUE O

DATE 26 OCT 2007



SCALE 4:1

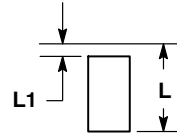
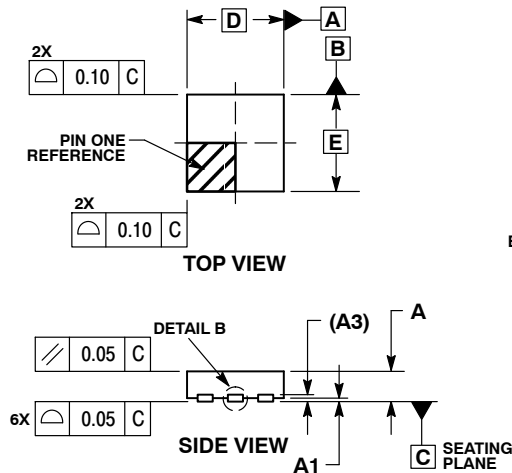

DETAIL A
OPTIONAL
CONSTRUCTION

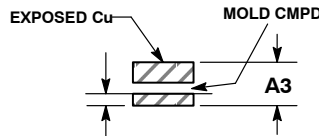

DETAIL B
OPTIONAL
CONSTRUCTION

NOTES:

1. DIMENSIONING AND TOLERANCING PER ASME Y14.5M, 1994.
2. CONTROLLING DIMENSION: MILLIMETERS.
3. DIMENSION b APPLIES TO PLATED TERMINAL AND IS MEASURED BETWEEN 0.15 AND 0.30 mm FROM TERMINAL.
4. COPLANARITY APPLIES TO THE EXPOSED PAD AS WELL AS THE TERMINALS.

| MILLIMETERS | | |
|-------------|------|------|
| DIM | MIN | MAX |
| A | 0.45 | 0.55 |
| A1 | 0.00 | 0.05 |
| A3 | 0.13 | REF |
| b | 0.20 | 0.30 |
| D | 1.60 | BSC |
| E | 1.60 | BSC |
| e | 0.50 | BSC |
| D2 | 1.10 | 1.30 |
| E2 | 0.45 | 0.65 |
| K | 0.20 | --- |
| L | 0.20 | 0.40 |
| L1 | 0.00 | 0.15 |

GENERIC MARKING DIAGRAM*

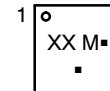

- XX = Specific Device Code
- M = Date Code
- = Pb-Free Package

(Note: Microdot may be in either location)
*This information is generic. Please refer to device data sheet for actual part marking.
Pb-Free indicator, "G" or microdot "■", may or may not be present.

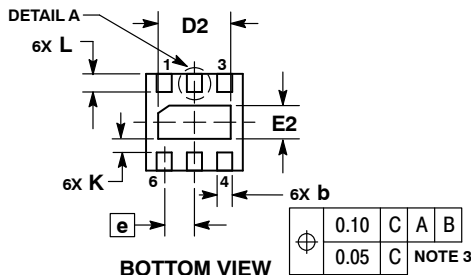

BOTTOM VIEW SOLDERMASK DEFINED MOUNTING FOOTPRINT*

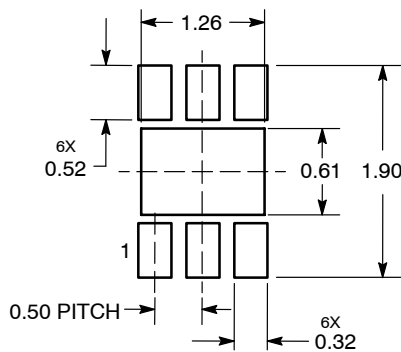

DIMENSIONS: MILLIMETERS

*For additional information on our Pb-Free strategy and soldering details, please download the ON Semiconductor Soldering and Mounting Techniques Reference Manual, SOLDERM/D.

| | | |
|-------------------------|----------------------------------|--|
| DOCUMENT NUMBER: | 98AON25711D | Electronic versions are uncontrolled except when accessed directly from the Document Repository. Printed versions are uncontrolled except when stamped "CONTROLLED COPY" in red. |
| DESCRIPTION: | 6 PIN UDFN, 1.6X1.6, 0.5P | PAGE 1 OF 1 |

ON Semiconductor and ON are trademarks of Semiconductor Components Industries, LLC dba ON Semiconductor or its subsidiaries in the United States and/or other countries. ON Semiconductor reserves the right to make changes without further notice to any products herein. ON Semiconductor makes no warranty, representation or guarantee regarding the suitability of its products for any particular purpose, nor does ON Semiconductor assume any liability arising out of the application or use of any product or circuit, and specifically disclaims any and all liability, including without limitation special, consequential or incidental damages. ON Semiconductor does not convey any license under its patent rights nor the rights of others.

onsemi, **Onsemi**, and other names, marks, and brands are registered and/or common law trademarks of Semiconductor Components Industries, LLC dba "**onsemi**" or its affiliates and/or subsidiaries in the United States and/or other countries. **onsemi** owns the rights to a number of patents, trademarks, copyrights, trade secrets, and other intellectual property. A listing of **onsemi**'s product/patent coverage may be accessed at www.onsemi.com/site/pdf/Patent-Marking.pdf. **onsemi** reserves the right to make changes at any time to any products or information herein, without notice. The information herein is provided "as-is" and **onsemi** makes no warranty, representation or guarantee regarding the accuracy of the information, product features, availability, functionality, or suitability of its products for any particular purpose, nor does **onsemi** assume any liability arising out of the application or use of any product or circuit, and specifically disclaims any and all liability, including without limitation special, consequential or incidental damages. Buyer is responsible for its products and applications using **onsemi** products, including compliance with all laws, regulations and safety requirements or standards, regardless of any support or applications information provided by **onsemi**. "Typical" parameters which may be provided in **onsemi** data sheets and/or specifications can and do vary in different applications and actual performance may vary over time. All operating parameters, including "Typicals" must be validated for each customer application by customer's technical experts. **onsemi** does not convey any license under any of its intellectual property rights nor the rights of others. **onsemi** products are not designed, intended, or authorized for use as a critical component in life support systems or any FDA Class 3 medical devices or medical devices with a same or similar classification in a foreign jurisdiction or any devices intended for implantation in the human body. Should Buyer purchase or use **onsemi** products for any such unintended or unauthorized application, Buyer shall indemnify and hold **onsemi** and its officers, employees, subsidiaries, affiliates, and distributors harmless against all claims, costs, damages, and expenses, and reasonable attorney fees arising out of, directly or indirectly, any claim of personal injury or death associated with such unintended or unauthorized use, even if such claim alleges that **onsemi** was negligent regarding the design or manufacture of the part. **onsemi** is an Equal Opportunity/Affirmative Action Employer. This literature is subject to all applicable copyright laws and is not for resale in any manner.

ADDITIONAL INFORMATION

TECHNICAL PUBLICATIONS:

Technical Library: www.onsemi.com/design/resources/technical-documentation
onsemi Website: www.onsemi.com

ONLINE SUPPORT: www.onsemi.com/support

For additional information, please contact your local Sales Representative at www.onsemi.com/support/sales