



Is Now Part of



**ON Semiconductor®**

To learn more about ON Semiconductor, please visit our website at  
[www.onsemi.com](http://www.onsemi.com)

Please note: As part of the Fairchild Semiconductor integration, some of the Fairchild orderable part numbers will need to change in order to meet ON Semiconductor's system requirements. Since the ON Semiconductor product management systems do not have the ability to manage part nomenclature that utilizes an underscore (\_), the underscore (\_) in the Fairchild part numbers will be changed to a dash (-). This document may contain device numbers with an underscore (\_). Please check the ON Semiconductor website to verify the updated device numbers. The most current and up-to-date ordering information can be found at [www.onsemi.com](http://www.onsemi.com). Please email any questions regarding the system integration to [Fairchild\\_questions@onsemi.com](mailto:Fairchild_questions@onsemi.com).

ON Semiconductor and the ON Semiconductor logo are trademarks of Semiconductor Components Industries, LLC dba ON Semiconductor or its subsidiaries in the United States and/or other countries. ON Semiconductor owns the rights to a number of patents, trademarks, copyrights, trade secrets, and other intellectual property. A listing of ON Semiconductor's product/patent coverage may be accessed at [www.onsemi.com/site/pdf/Patent-Marking.pdf](http://www.onsemi.com/site/pdf/Patent-Marking.pdf). ON Semiconductor reserves the right to make changes without further notice to any products herein. ON Semiconductor makes no warranty, representation or guarantee regarding the suitability of its products for any particular purpose, nor does ON Semiconductor assume any liability arising out of the application or use of any product or circuit, and specifically disclaims any and all liability, including without limitation special, consequential or incidental damages. Buyer is responsible for its products and applications using ON Semiconductor products, including compliance with all laws, regulations and safety requirements or standards, regardless of any support or applications information provided by ON Semiconductor. "Typical" parameters which may be provided in ON Semiconductor data sheets and/or specifications can and do vary in different applications and actual performance may vary over time. All operating parameters, including "Typicals" must be validated for each customer application by customer's technical experts. ON Semiconductor does not convey any license under its patent rights nor the rights of others. ON Semiconductor products are not designed, intended, or authorized for use as a critical component in life support systems or any FDA Class 3 medical devices or medical devices with a same or similar classification in a foreign jurisdiction or any devices intended for implantation in the human body. Should Buyer purchase or use ON Semiconductor products for any such unintended or unauthorized application, Buyer shall indemnify and hold ON Semiconductor and its officers, employees, subsidiaries, affiliates, and distributors harmless against all claims, costs, damages, and expenses, and reasonable attorney fees arising out of, directly or indirectly, any claim of personal injury or death associated with such unintended or unauthorized use, even if such claim alleges that ON Semiconductor was negligent regarding the design or manufacture of the part. ON Semiconductor is an Equal Opportunity/Affirmative Action Employer. This literature is subject to all applicable copyright laws and is not for resale in any manner.

## FIN1018 3.3V LVDS 1-Bit High Speed Differential Receiver

### General Description

This single receiver is designed for high speed interconnects utilizing Low Voltage Differential Signaling (LVDS) technology. The receiver translates LVDS levels, with a typical differential input threshold of 100 mV, to LVTTTL signal levels. LVDS provides low EMI at ultra low power dissipation even at high frequencies. This device is ideal for high speed transfer of clock or data.

The FIN1018 can be paired with its companion driver, the FIN1017, or with any other LVDS driver.

### Features

- Greater than 400Mbps data rate
- 3.3V power supply operation
- 0.4ns maximum pulse skew
- 2.5ns maximum propagation delay
- Low power dissipation
- Power-Off protection
- Fail safe protection for open-circuit, shorted and terminated conditions
- Meets or exceeds the TIA/EIA-644 LVDS standard
- Flow-through pinout simplifies PCB layout
- 8-Lead SOIC and US-8 packages save space

### Ordering Code:

Order Number	Package Number	Package Description
FIN1018M	M08A	8-Lead Small Outline Integrated Circuit (SOIC), JEDEC MS-012, 0.150" Narrow [TUBE]
FIN1018MX	M08A	8-Lead Small Outline Integrated Circuit (SOIC), JEDEC MS-012, 0.150" Narrow [TAPE and REEL]
FIN1018K8X	MAB08A	8-Lead US8, JEDEC MO-187, Variation CA 3.1mm Wide [TAPE and REEL]

### Pin Descriptions

Pin Name	Description
R <sub>OUT</sub>	LVTTTL Data Output
R <sub>IN+</sub>	Non-inverting Driver Input
R <sub>IN-</sub>	Inverting Driver Input
V <sub>CC</sub>	Power Supply
GND	Ground
NC	No Connect

### Connection Diagrams

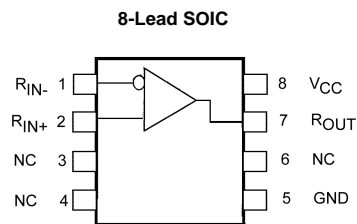

### Function Table

Input		Outputs
R <sub>IN+</sub>	R <sub>IN-</sub>	R <sub>OUT</sub>
L	H	L
H	L	H
Fail Safe Condition		H

H = HIGH Logic Level  
L = LOW Logic Level  
Fail Safe = Open, Shorted, Terminated

### Pin Assignment for US-8 Package

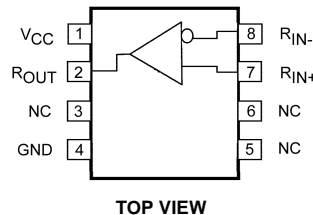

**Absolute Maximum Ratings**(Note 1)

Supply Voltage ( $V_{CC}$ )	-0.5V to +4.6V
DC Input Voltage ( $R_{IN+}$ , $R_{IN-}$ )	-0.5V to +4.7V
DC Output Voltage ( $D_{OUT}$ )	-0.5V to +6V
DC Output Current ( $I_O$ )	16 mA
Storage Temperature Range ( $T_{STG}$ )	-65°C to +150°C
Max Junction Temperature ( $T_J$ )	150°C
Lead Temperature ( $T_L$ ) (Soldering, 10 seconds)	260°C
ESD (Human Body Model)	≥ 6500V
ESD (Bus Pins $R_{IN-}/R_{IN+}$ to GND)	≥ 9500V
ESD (Machine Model)	≥ 300V

**Recommended Operating Conditions**

Supply Voltage ( $V_{CC}$ )	3.0V to 3.6V
Input Voltage ( $V_{IN}$ )	0 to $V_{CC}$
Magnitude of Differential Voltage ( $ V_{ID} $ )	100mV to $V_{CC}$
Common-mode Input Voltage ( $V_{IC}$ )	0.05V to 2.35V
Operating Temperature ( $T_A$ )	-40°C to +85°C

**Note 1:** The "Absolute Maximum Ratings" are those values beyond which damage to the device may occur. The databook specifications should be met, without exception, to ensure that the system design is reliable over its power supply, temperature and output/input loading variables. Fairchild does not recommend operation of circuits outside databook specification.

**DC Electrical Characteristics**

Over supply voltage and operating temperature ranges, unless otherwise specified

Symbol	Parameter	Test Conditions	Min	Typ (Note 2)	Max	Units
$V_{TH}$	Differential Input Threshold HIGH	See Figure 1 and Table 1			100	mV
$V_{TL}$	Differential Input Threshold LOW	See Figure 1 and Table 1	-100			mV
$I_{IN}$	Input Current	$V_{IN} = 0V$ or $V_{CC}$			±20	μA
$I_{I(OFF)}$	Power-OFF Input Current	$V_{CC} = 0V$ , $V_{IN} = 0V$ or 3.6V			±20	μA
$V_{OH}$	Output HIGH Voltage	$I_{OH} = -100 \mu A$	$V_{CC} - 0.2$			V
		$I_{OH} = -8 \text{ mA}$	2.4			V
$V_{OL}$	Output LOW Voltage	$I_{OH} = 100 \mu A$			0.2	V
		$I_{OL} = 8 \text{ mA}$			0.5	V
$V_{IK}$	Input Clamp Voltage	$I_{IK} = -18 \text{ mA}$	-1.5			V
$I_{CC}$	Power Supply Current	Inputs Open, ( $R_{IN+} = 1V$ and $R_{IN-} = 1.4V$ ), or ( $R_{IN+} = 1.4V$ and $R_{IN-} = 1V$ )			7	mA
$C_{IN}$	Input Capacitance			4		pF
$C_{OUT}$	Output Capacitance			6		pF

**Note 2:** All typical values are at  $T_A = 25^\circ\text{C}$  and with  $V_{CC} = 3.3V$ .

**AC Electrical Characteristics**

Over supply voltage and operating temperature ranges, unless otherwise specified

Symbol	Parameter	Test Conditions	Min	Typ (Note 3)	Max	Units
$t_{PLH}$	Propagation Delay LOW-to-HIGH	$ V_{ID}  = 400 \text{ mV}$ , $C_L = 10 \text{ pF}$ See Figure 1 and Figure 2	0.9		2.5	ns
$t_{PHL}$	Propagation Delay HIGH-to-LOW		0.9		2.5	ns
$t_{TLH}$	Output Rise Time (20% to 80%)		0.5			ns
$t_{THL}$	Output Fall Time (80% to 20%)		0.5			ns
$t_{SK(P)}$	Pulse Skew [ $t_{PLH} - t_{PHL}$ ]				0.4	ns
$t_{SK(PP)}$	Part-to-Part Skew (Note 4)				1.0	ns

**Note 3:** All typical values are at  $T_A = 25^\circ\text{C}$  and with  $V_{CC} = 3.3V$ .

**Note 4:**  $t_{SK(PP)}$  is the magnitude of the difference in propagation delay times between any specified terminals of two devices switching in the same direction (either LOW-to-HIGH or HIGH-to-LOW) when both devices operate with the same supply voltage, same temperature, and have identical test circuits.

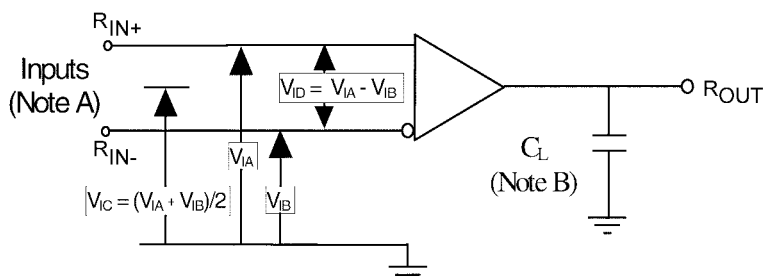

**Note A:** All input pulses have frequency = 10MHz,  $t_r$  or  $t_f$  = 1ns

**Note B:**  $C_L$  includes all probe and fixture capacitances

**FIGURE 1. Differential Receiver Voltage Definitions and Propagation Delay and Transition Time Test Circuit**

**TABLE 1. Receiver Minimum and Maximum Input Threshold Test Voltages**

Applied Voltages (V)		Resulting Differential Input Voltage (mV)	Resulting Common Mode Input Voltage (V)
$V_{IA}$	$V_{IB}$	$V_{ID}$	$V_{IC}$
1.25	1.15	100	1.2
1.15	1.25	-100	1.2
2.4	2.3	100	2.35
2.3	2.4	-100	2.35
0.1	0	100	0.05
0	0.1	-100	0.05
1.5	0.9	600	1.2
0.9	1.5	-600	1.2
2.4	1.8	600	2.1
1.8	2.4	-600	2.1
0.6	0	600	0.3
0	0.6	-600	0.3

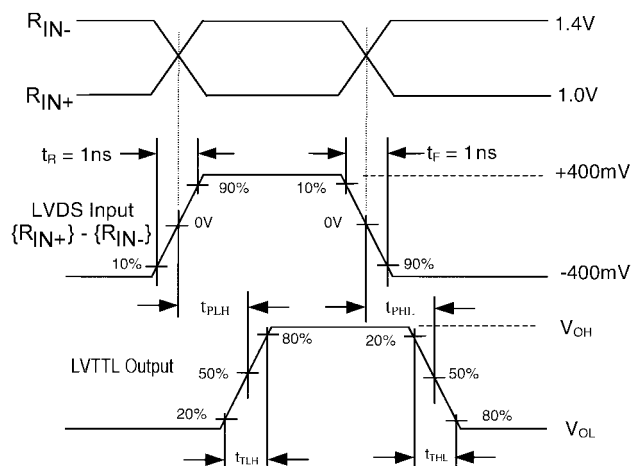

**FIGURE 2. LVDS Input to LVTTTL Output AC Waveforms**

DC / AC Typical Performance Curves

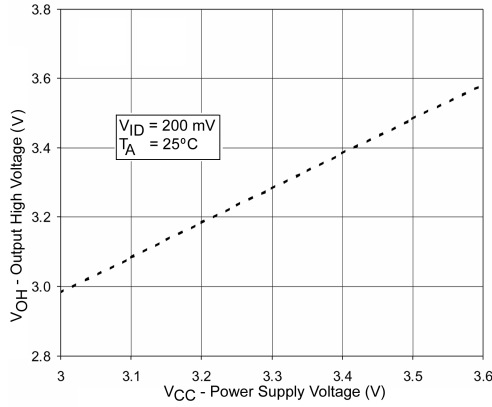

FIGURE 3. Output High Voltage vs. Power Supply Voltage

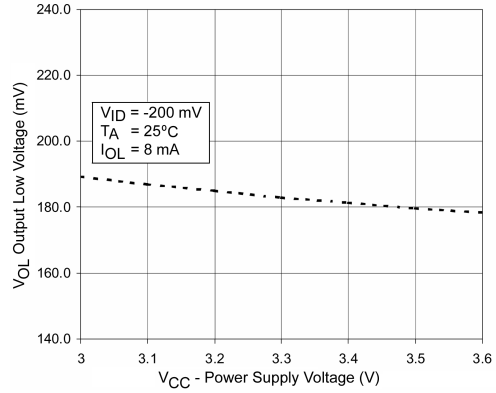

FIGURE 4. Output Low Voltage vs. Power Supply Voltage

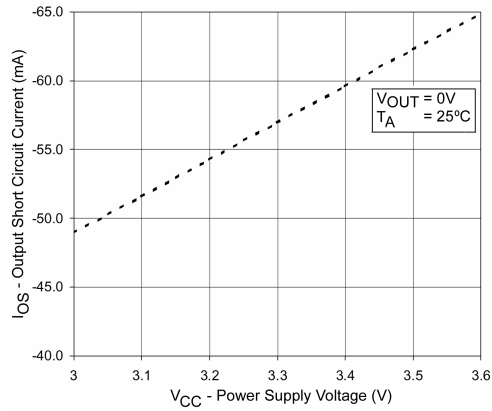

FIGURE 5. Output Short Circuit Current vs. Power Supply Voltage

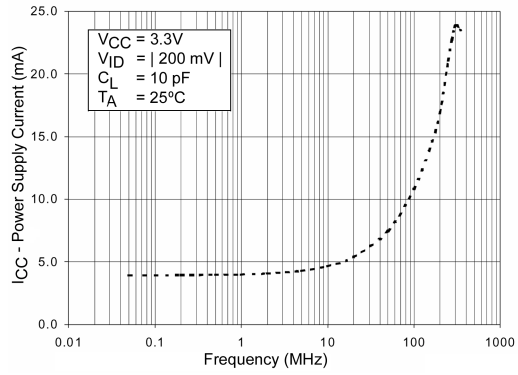

FIGURE 6. Power Supply Current vs. Frequency

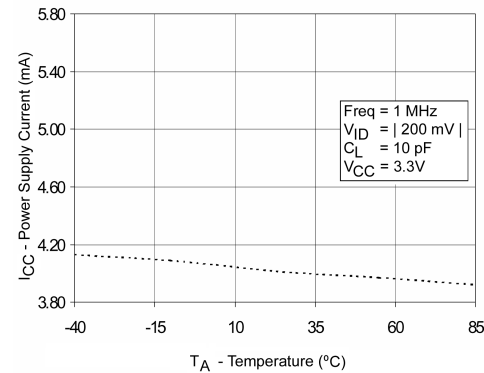

FIGURE 7. Power Supply Current vs. Ambient Temperature

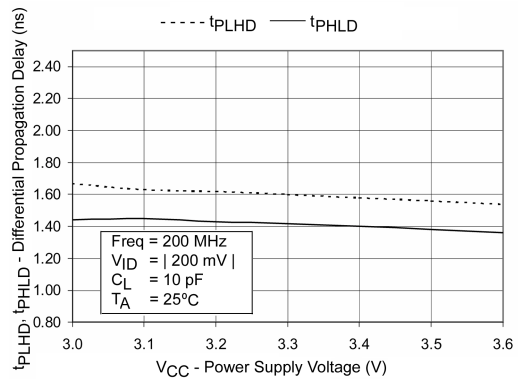

FIGURE 8. Differential Propagation Delay Power Supply Voltage

DC / AC Typical Performance Curves (Continued)

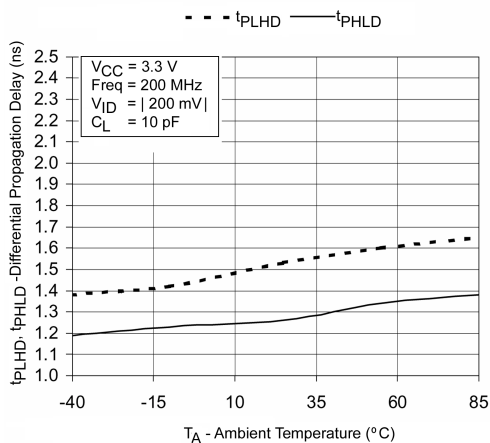

FIGURE 9. Differential Propagation Delay vs. Ambient Temperature

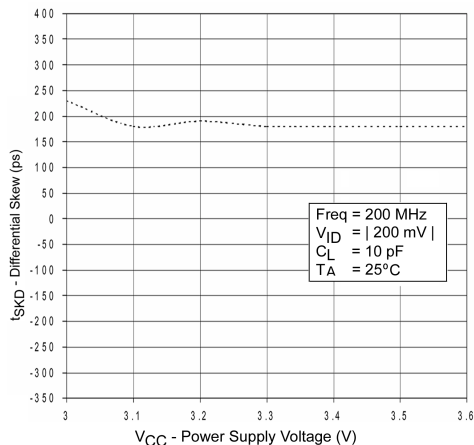

FIGURE 10. Differential Skew vs. Power Supply Voltage

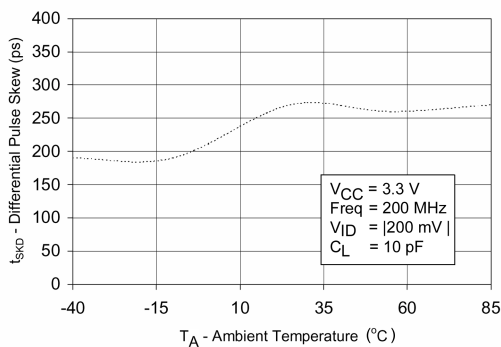

FIGURE 11. Differential Skew vs. Ambient Temperature

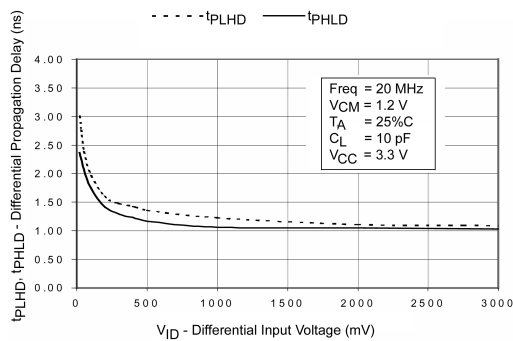

FIGURE 12. Differential Propagation Delay vs. Differential Input Voltage

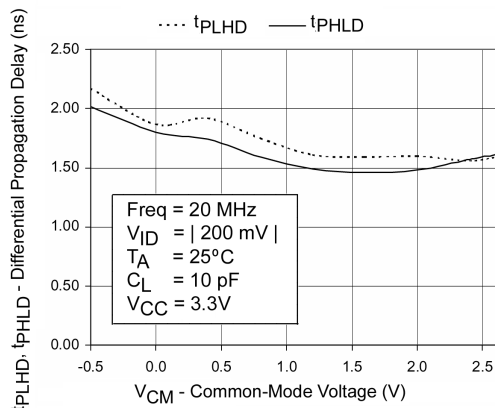

FIGURE 13. Differential Propagation Delay vs. Common-Mode Voltage

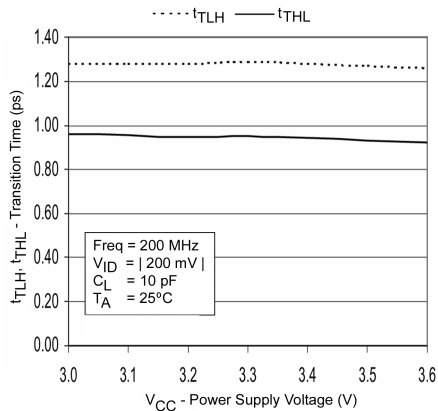

FIGURE 14. Transition Time vs. Power Supply Voltage

DC / AC Typical Performance Curves (Continued)

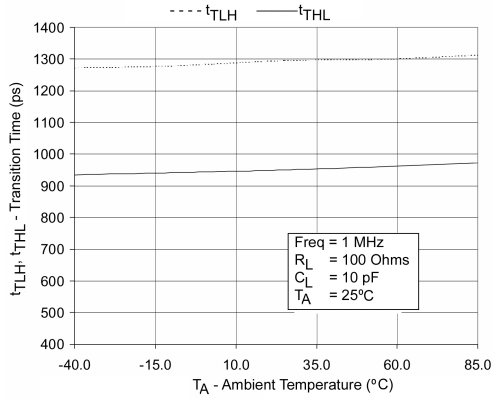

FIGURE 15. Transition Time vs. Ambient Temperature

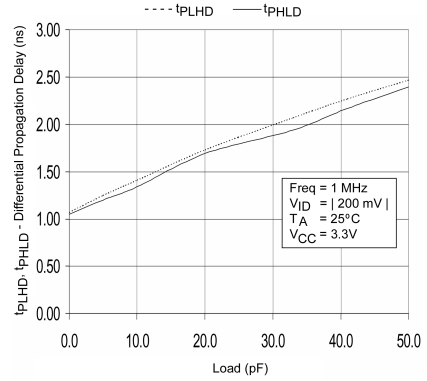

FIGURE 16. Differential Propagation Delay vs. Load

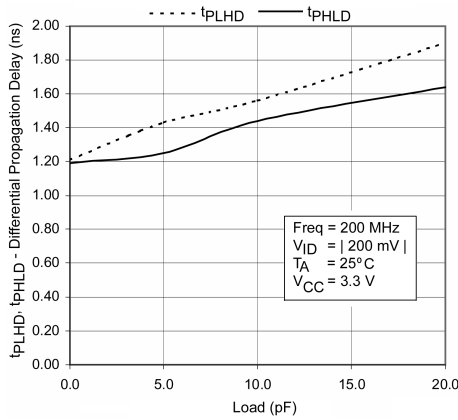

FIGURE 17. Differential Propagation Delay vs. Load

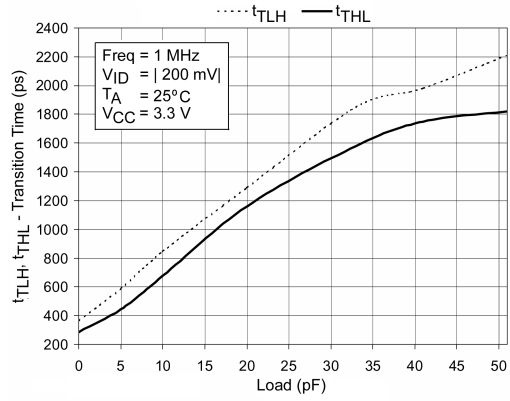

FIGURE 18. Transition Time vs. Load

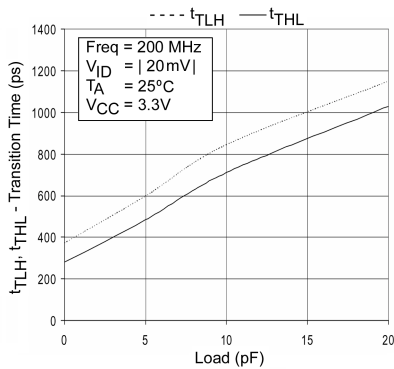

FIGURE 19. Transition Time vs. Load

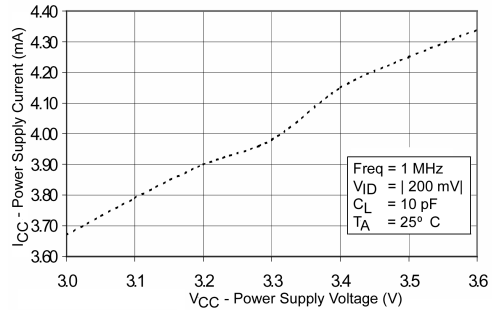
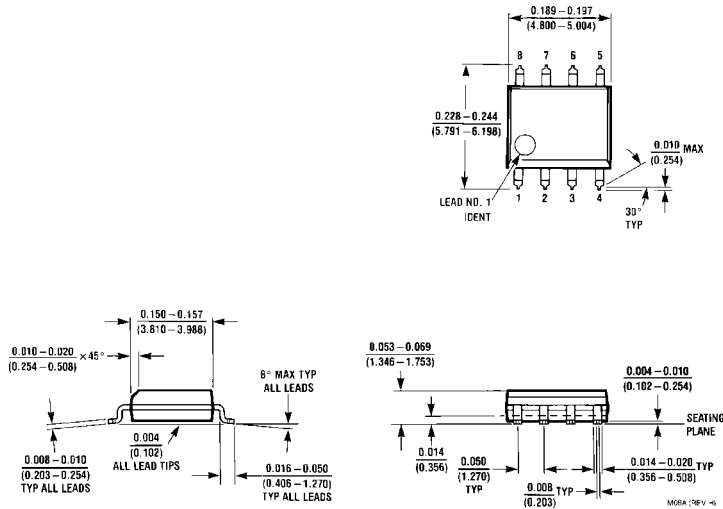

FIGURE 20. Power Supply Current vs. Power Supply Voltage

**Physical Dimensions** inches (millimeters) unless otherwise noted



**8-Lead Small Outline Integrated Circuit (SOIC), JEDEC MS-012, 0.150" Narrow  
Package Number M08A**



**Physical Dimensions** inches (millimeters) unless otherwise noted (Continued)

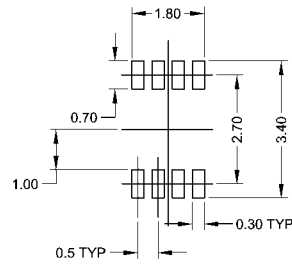
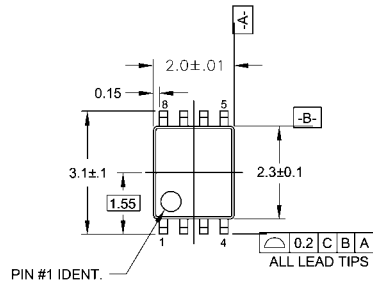

**LAND PATTERN RECOMMENDATION**

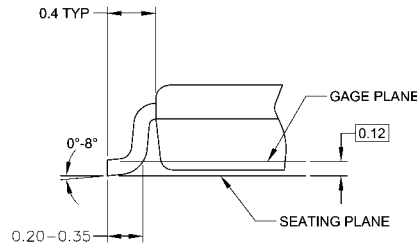
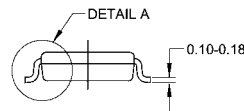
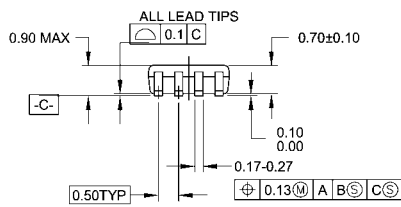

**DETAIL A**

**NOTES:**

- A. CONFORMS TO JEDEC REGISTRATION MO-187
- B. DIMENSIONS ARE IN MILLIMETERS.
- C. DIMENSIONS ARE EXCLUSIVE OF BURRS, MOLD FLASH, AND TIE BAR EXTRUSIONS.
- D. DIMENSIONS AND TOLERANCES PER ANSI Y14.5M, 1982.

MAB08AREVC

**8-Lead US8, JEDEC MO-187, Variation CA 3.1mm Wide  
Package Number MAB08A**

Fairchild does not assume any responsibility for use of any circuitry described, no circuit patent licenses are implied and Fairchild reserves the right at any time without notice to change said circuitry and specifications.

**LIFE SUPPORT POLICY**

FAIRCHILD'S PRODUCTS ARE NOT AUTHORIZED FOR USE AS CRITICAL COMPONENTS IN LIFE SUPPORT DEVICES OR SYSTEMS WITHOUT THE EXPRESS WRITTEN APPROVAL OF THE PRESIDENT OF FAIRCHILD SEMICONDUCTOR CORPORATION. As used herein:

1. Life support devices or systems are devices or systems which, (a) are intended for surgical implant into the body, or (b) support or sustain life, and (c) whose failure to perform when properly used in accordance with instructions for use provided in the labeling, can be reasonably expected to result in a significant injury to the user.
2. A critical component in any component of a life support device or system whose failure to perform can be reasonably expected to cause the failure of the life support device or system, or to affect its safety or effectiveness.

[www.fairchildsemi.com](http://www.fairchildsemi.com)

ON Semiconductor and  are trademarks of Semiconductor Components Industries, LLC dba ON Semiconductor or its subsidiaries in the United States and/or other countries. ON Semiconductor owns the rights to a number of patents, trademarks, copyrights, trade secrets, and other intellectual property. A listing of ON Semiconductor's product/patent coverage may be accessed at [www.onsemi.com/site/pdf/Patent-Marking.pdf](http://www.onsemi.com/site/pdf/Patent-Marking.pdf). ON Semiconductor reserves the right to make changes without further notice to any products herein. ON Semiconductor makes no warranty, representation or guarantee regarding the suitability of its products for any particular purpose, nor does ON Semiconductor assume any liability arising out of the application or use of any product or circuit, and specifically disclaims any and all liability, including without limitation special, consequential or incidental damages. Buyer is responsible for its products and applications using ON Semiconductor products, including compliance with all laws, regulations and safety requirements or standards, regardless of any support or applications information provided by ON Semiconductor. "Typical" parameters which may be provided in ON Semiconductor data sheets and/or specifications can and do vary in different applications and actual performance may vary over time. All operating parameters, including "Typicals" must be validated for each customer application by customer's technical experts. ON Semiconductor does not convey any license under its patent rights nor the rights of others. ON Semiconductor products are not designed, intended, or authorized for use as a critical component in life support systems or any FDA Class 3 medical devices or medical devices with a same or similar classification in a foreign jurisdiction or any devices intended for implantation in the human body. Should Buyer purchase or use ON Semiconductor products for any such unintended or unauthorized application, Buyer shall indemnify and hold ON Semiconductor and its officers, employees, subsidiaries, affiliates, and distributors harmless against all claims, costs, damages, and expenses, and reasonable attorney fees arising out of, directly or indirectly, any claim of personal injury or death associated with such unintended or unauthorized use, even if such claim alleges that ON Semiconductor was negligent regarding the design or manufacture of the part. ON Semiconductor is an Equal Opportunity/Affirmative Action Employer. This literature is subject to all applicable copyright laws and is not for resale in any manner.

## PUBLICATION ORDERING INFORMATION

### LITERATURE FULFILLMENT:

Literature Distribution Center for ON Semiconductor  
19521 E. 32nd Pkwy, Aurora, Colorado 80011 USA  
**Phone:** 303-675-2175 or 800-344-3860 Toll Free USA/Canada  
**Fax:** 303-675-2176 or 800-344-3867 Toll Free USA/Canada  
**Email:** [orderlit@onsemi.com](mailto:orderlit@onsemi.com)

**N. American Technical Support:** 800-282-9855 Toll Free  
USA/Canada  
**Europe, Middle East and Africa Technical Support:**  
Phone: 421 33 790 2910  
**Japan Customer Focus Center**  
Phone: 81-3-5817-1050

**ON Semiconductor Website:** [www.onsemi.com](http://www.onsemi.com)  
**Order Literature:** <http://www.onsemi.com/orderlit>  
For additional information, please contact your local  
Sales Representative