

# SCAN921821 Dual 18-Bit Serializer with Pre-emphasis, IEEE 1149.1 (JTAG), and At-Speed BIST

Check for Samples: [SCAN921821](#)

## FEATURES

- **15-66 MHz Dual 18:1 Serializer with 2.376 Gbps Total Throughput**
- **8-level Selectable Pre-emphasis on Each Channel Drives Lossy Cables and Backplanes**
- **>15kV HBM ESD Protection on Bus LVDS I/O Pins**
- **Robust BLVDS Serial Data Transmission with Embedded Clock for Exceptional Noise Immunity and Low EMI**
- **Power Saving Control Pin for Each Channel**
- **IEEE 1149.1 "JTAG" Compliant**
- **At-Speed BIST - PRBS Generation**
- **No External Coding Required**
- **Internal PLL, No External PLL Components Required**
- **Single +3.3V Power Supply**
- **Low Power: 260 mW (typ) Per Channel at 66 MHz with PRBS-15 Pattern**
- **Single 3.3 V Supply**
- **Fabricated with Advanced CMOS Process Technology**
- **Industrial –40 to +85°C Temperature Range**
- **Compact 100-ball NFBGA Package**

## DESCRIPTION

The SCAN921821 is a dual channel 18-bit serializer featuring signal conditioning, boundary SCAN, and at-speed BIST. Each serializer block transforms an 18-bit parallel LVCMOS/LVTTL data bus into a single Bus LVDS data stream with embedded clock. This single serial data stream with embedded clock simplifies PCB design and reduces PCB cost by narrowing data paths that in turn reduce PCB size and layers. The single serial data stream also reduces cable size, the number of connectors, and eliminates clock-to-data and data-to-data skew.

Each channel also has an 8-level selectable pre-emphasis feature that significantly extends performance over lossy interconnect. Each channel also has its own powerdown pin that saves power by reducing supply current when the channel is not being used.

The SCAN921821 also incorporates advanced testability features including IEEE 1149.1 and at-speed BIST PRBS pattern generation to facilitate verification of board and link integrity



Please be aware that an important notice concerning availability, standard warranty, and use in critical applications of Texas Instruments semiconductor products and disclaimers thereto appears at the end of this data sheet.

All trademarks are the property of their respective owners.

**Block Diagram**

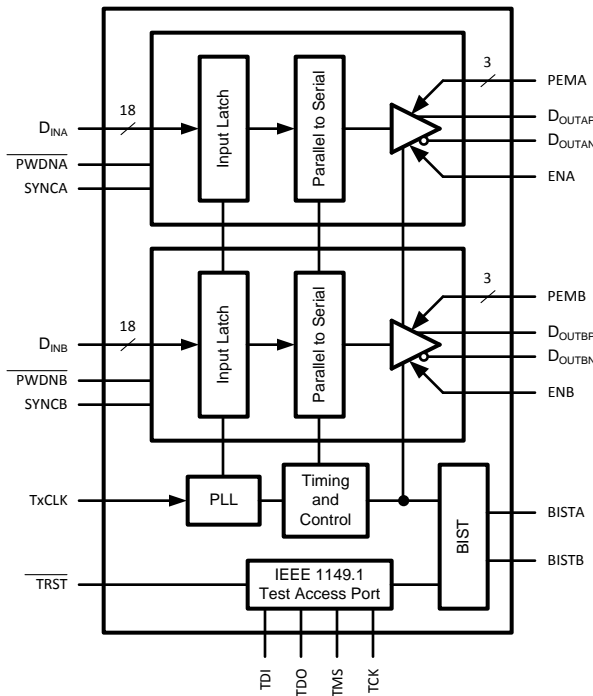

These devices have limited built-in ESD protection. The leads should be shorted together or the device placed in conductive foam during storage or handling to prevent electrostatic damage to the MOS gates.

**Absolute Maximum Ratings (1)(2)**

Supply Voltage (V <sub>DD</sub> )		-0.3V to +4V	
Supply Voltage (V <sub>DD</sub> ) Ramp Rate		< 30 V/ms	
LVC MOS/LVTTL Input Voltage		-0.3V to (V <sub>DD</sub> +0.3V)	
LVC MOS/LVTTL Output Voltage		-0.3V to (V <sub>DD</sub> +0.3V)	
Bus LVDS Driver Output Voltage		-0.3V to +3.9V	
Bus LVDS Output Short Circuit Duration		10ms	
Junction Temperature		+150°C	
Storage Temperature		-65°C to +150°C	
Lead Temperature (Soldering, 4 seconds)		+220°C	
Maximum Package Power Dissipation at 25°C	NFBGA-100	3.57 W	
	Derating Above 25°C	28.57 mW/°C	
Thermal resistance	θ <sub>JA</sub>	35°C/W	
	θ <sub>JC</sub>	11.1°C/W	
ESD Rating	HBM, 1.5 KΩ, 100 pF	All pins	>8 kV
		Bus LVDS pins	>15 kV
	MM, 0Ω, 200 pF		>1200 V
	CDM		>2 kV

- (1) "Absolute Maximum Ratings" are those values beyond which the safety of the device cannot be specified. They are not meant to imply that the devices should be operated at these limits. The table of "Electrical Characteristics" specifies conditions of device operation.
- (2) If Military/Aerospace specified devices are required, please contact the TI Sales Office/ Distributors for availability and specifications.

## Recommended Operating Conditions

	Min	Nom	Max	Units
Supply Voltage ( $V_{DD}$ )	3.15	3.3	3.45	V
Operating Free Air Temperature ( $T_A$ )	-40	+25	+85	°C
Clock Rate	15		66	MHz
Supply Noise			100	mV p-p

## DC Electrical Characteristics

Over recommended operating supply and temperature ranges unless otherwise specified. <sup>(1)(2)</sup>

Symbol	Parameter	Conditions	Min	Typ	Max	Units
<b>LVCMOS/LVTTL Input DC Specifications</b>						
$V_{IH}$	High Level Input Voltage		2.0		$V_{DD}$	V
$V_{IL}$	Low Level Input Voltage		GND		0.8	V
$V_{CL}$	Input Clamp Voltage	$I_{CL} = -18 \text{ mA}$	-1.5	-0.7		V
$I_{INH}$	High Level Input Current	$V_{IN} = V_{DD} = V_{DDMAX}$	-20	±2	+20	µA
$I_{INL}$	Low Level Output Current	$V_{IN} = V_{SS}, V_{DD} = V_{DDMAX}$	-10	±2	+10	µA
<b>1149.1 (JTAG) DC Specifications</b>						
$V_{IH}$	High Level Input Voltage		2.0		$V_{DD}$	V
$V_{IL}$	Low Level Input Voltage		GND		0.8	V
$V_{CL}$	Input Clamp Voltage	$I_{CL} = -18 \text{ mA}$	-1.5	-0.7		V
$I_{INH}$	High Level Input Current	$V_{IN} = V_{DD} = V_{DDMAX}$	-20		+20	µA
$I_{INL}$	Low Level Output Current	$V_{IN} = V_{SS}, V_{DD} = V_{DDMAX}$	-200		+200	µA
$V_{OH}$	High Level Output Voltage	$I_{OH} = -9 \text{ mA}$	2.3		$V_{DD}$	mV
$V_{OL}$	Low Level Output Voltage	$I_{OL} = 9 \text{ mA}$	GND		0.5	mV
$I_{OS}$	Output Short Circuit Current	$V_{OUT} = 0 \text{ V}$	-100	-80	-50	mA
$I_{OZ}$	Output Tri-state Current	$\overline{\text{PWDN}}$ or $\text{EN} = 0.8\text{V}, V_{OUT} = 0 \text{ V}$	-10		+10	µA
		$\overline{\text{PWDN}}$ or $\text{EN} = 0.8\text{V}, V_{OUT} = V_{DD}$	-30		+30	µA
<b>Bus LVDS Output DC Specifications</b>						
$V_{OD}$	Output Differential Voltage (DO+) - (DO-)	See <a href="#">Figure 10</a> , $R_L = 100\Omega$	450	500	550	mV
$\Delta V_{OD}$	Output Differential Voltage Unbalance			2	15	mV
$V_{OS}$	Offset Voltage		1.05	1.2	1.25	V
$\Delta V_{OS}$	Offset Voltage Unbalance			2.7	15	mV

(1) Typical values are given for  $V_{CC} = 3.3\text{V}$  and  $T_A = +25^\circ\text{C}$ .

(2) Current into device pins is defined as positive. Current out of device pins is defined as negative. Voltages are referenced to ground except  $V_{OD}$ ,  $\Delta V_{OD}$ ,  $V_{TH}$  and  $V_{TL}$  which are differential voltages.

## DC Electrical Characteristics (continued)

Over recommended operating supply and temperature ranges unless otherwise specified.<sup>(1)(2)</sup>

Symbol	Parameter	Conditions	Min	Typ	Max	Units	
Q <sub>POV</sub>	Pre-Emphasis Output Voltage Ratio $ V_{ODPRE} / V_{OD} $	Pre-Emphasis Level = 1	1.10	1.24	1.35		
		Pre-Emphasis Level = 2	1.35	1.47	1.55		
		Pre-Emphasis Level = 3	1.55	1.70	1.80		
		Pre-Emphasis Level = 4	1.80	1.91	1.95		
		Pre-Emphasis Level = 5	1.95	2.08	2.20		
		Pre-Emphasis Level = 6	2.10	2.21	2.35		
		Pre-Emphasis Level = 7	2.15	2.30	2.50		
I <sub>OS</sub>	Output Short Circuit Current	DO = 0V, Din = H, $\overline{PWDN}$ and EN = 2.4V	-10	-25	-75	mA	
I <sub>OZ</sub>	TRI-STATE Output Current	$\overline{PWDN}$ or EN = 0.8V, DO = 0V <sup>(3)</sup>	-10	± 1	+10	µA	
		$\overline{PWDN}$ or EN = 0.8V, DO = VDD <sup>(3)</sup>	-55	± 6	+55	µA	
<b>Power Supply Current (DVDD, PVDD and AVDD Pins)</b>							
I <sub>DD</sub>	Total Supply Current (includes load current)	C <sub>L</sub> = 15pF, R <sub>L</sub> = 100 Ω	f = 66 MHz, PRBS-15 Pattern		160	225	mA
			f = 66 MHz, Worst Case Pattern (Checker-Board Pattern)		180		mA
I <sub>DDP</sub>	Total Supply Current with Pre-Emphasis (includes load current)	C <sub>L</sub> = 15pF, R <sub>L</sub> = 100 Ω	f = 66 MHz, PRBS-15 Pattern		240		mA
			f = 66 MHz, Worst Case Pattern (Checker-Board Pattern)		280	325	mA
I <sub>DDX</sub>	Supply Current Powerdown	$\overline{PWDN}$ = 0.8V, EN = 0.8V		1.0	3.0	mA	

(3) I<sub>OZ</sub> is measured at each pin. The DOUT pin not under test is floated to isolate the TRI-STATE current flow.

## Timing Requirements for TCLK

Over recommended operating supply and temperature ranges unless otherwise specified.<sup>(1)(2)</sup>

Symbol	Parameter	Conditions	Min	Typ	Max	Units
t <sub>TCP</sub>	Transmit Clock Period		15.2	T	66.7	ns
t <sub>TCH</sub>	Transmit Clock High Time		0.4T	0.5T	0.6T	ns
t <sub>TCL</sub>	Transmit Clock Low Time		0.4T	0.5T	0.6T	ns
t <sub>CLKT</sub>	TCLK Input Transition Time			3	6	ns
t <sub>JIT</sub>	TCLK Input Jitter	See <sup>(3)</sup>			80	ps (RMS)

(1) Typical values are given for V<sub>CC</sub> = 3.3V and T<sub>A</sub> = +25°C.

(2) Current into device pins is defined as positive. Current out of device pins is defined as negative. Voltages are referenced to ground except V<sub>OD</sub>, ΔV<sub>OD</sub>, V<sub>TH</sub> and V<sub>TL</sub> which are differential voltages.

(3) Specified by design using statistical analysis.

## AC Electrical Characteristics

 Over recommended operating supply and temperature ranges unless otherwise specified. <sup>(1)(2)</sup>

Symbol	Parameter	Conditions	Min	Typ	Max	Units
<b>Serializer AC Specifications</b>						
$t_{LLHT}$	Bus LVDS Low-to-High Transition Time	See <a href="#">Figure 2</a> , <sup>(3)</sup> $R_L = 100\Omega$ , $C_L = 10\text{pF}$ to GND		0.3	0.4	ns
$t_{LHLT}$	Bus LVDS High-to-Low Transition Time			0.3	0.4	ns
$t_{DIS}$	DIN (0-17) Setup to TCLK	See <a href="#">Figure 4</a> , <sup>(3)</sup> $R_L = 100\Omega$ , $C_L = 10\text{pF}$ to GND	1.9			ns
$t_{DIH}$	DIN (0-17) Hold from TCLK		0.6			ns
$t_{HZD}$	DO $\pm$ HIGH to TRI-STATE Delay	See <a href="#">Figure 5</a> $R_L = 100\Omega$ , $C_L = 10\text{pF}$ to GND		3.9	10	ns
$t_{LZD}$	DO $\pm$ LOW to TRI-STATE Delay			3.5	10	ns
$t_{ZHD}$	DO $\pm$ TRI-STATE to HIGH Delay			3.2	10	ns
$t_{ZLD}$	DO $\pm$ TRI-STATE to LOW Delay			2.4	10	ns
$t_{SPW}$	SYNC Pulse Width	See <a href="#">Figure 7</a> , $R_L = 100\Omega$	$5 \cdot t_{TCP}$		$6 \cdot t_{TCP}$	ns
$t_{PLD}$	Serializer PLL Lock Time	See <a href="#">Figure 6</a> , $R_L = 100\Omega$	$510 \cdot t_{TCP}$		$1024 \cdot t_{TCP}$	ns
$t_{SD}$	Serializer Delay	See <a href="#">Figure 8</a> , $R_L = 100\Omega$	$t_{TCP} + 2.5$	$t_{TCP} + 4.5$	$t_{TCP} + 6.5$	ns
$t_{SKCC}$	Channel to Channel Skew			70		ps
$t_{RJIT}$	Random Jitter	Room Temperature, $V_{DD} = 3.3\text{V}$ , 66 MHz		6.1		ps (RMS)
$t_{DJIT}$	Deterministic Jitter <a href="#">Figure 9</a> , <sup>(3)</sup>	15 MHz	-390		320	ps
		66 MHz	-60		30	ps
<b>1149.1 (JTAG) AC Specifications</b>						
$f_{MAX}$	Maximum TCK Clock Frequency	$C_L = 15\text{pF}$ , $R_L = 500\Omega$	25			MHz
$t_S$	TDI or TMS Setup to TCK, H or L		2.4			ns
$t_H$	TDI or TMS Hold from TCK, H or L		2.8			ns
$t_{W1}$	TCK Pulse Width, H or L		10			ns
$t_{W2}$	$\overline{\text{TRST}}$ Pulse Width, L		10			ns
$t_{REC}$	Recovery Time, $\overline{\text{TRST}}$ to TCK		2			ns

 (1) Typical values are given for  $V_{CC} = 3.3\text{V}$  and  $T_A = +25^\circ\text{C}$ .

 (2) Current into device pins is defined as positive. Current out of device pins is defined as negative. Voltages are referenced to ground except VOD,  $\Delta\text{VOD}$ , VTH and VTL which are differential voltages.

(3) Specified by design using statistical analysis.

AC Timing Diagrams and Test Circuits

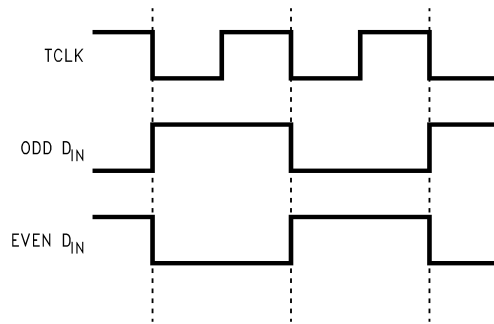

Figure 1. "Worst Case" Serializer IDD Test Pattern

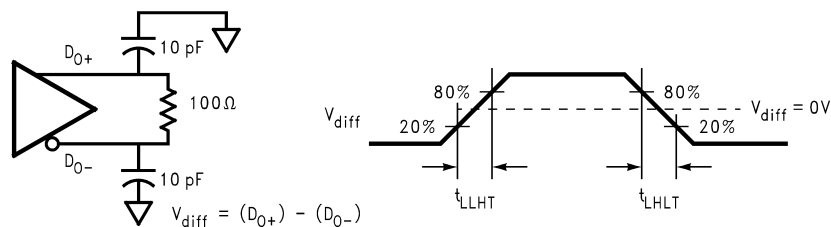

Figure 2. Serializer Bus LVDS Distributed Output Load and Transition Times

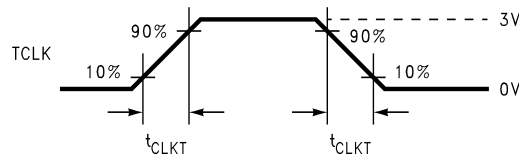

Figure 3. Serializer Input Clock Transition Time

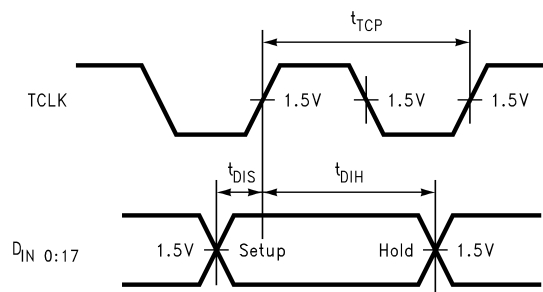

Figure 4. Serializer Setup/Hold Times

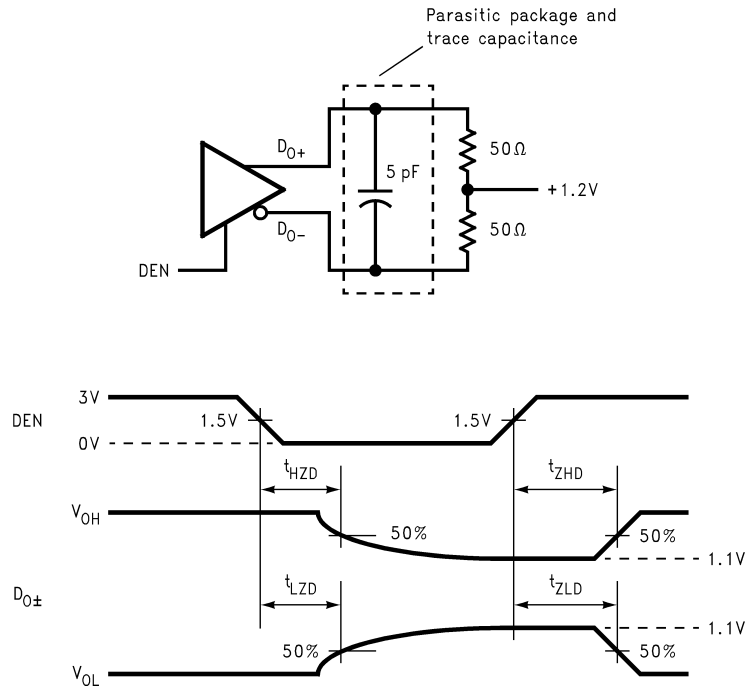

Figure 5. Serializer TRI-STATE Test Circuit and Timing

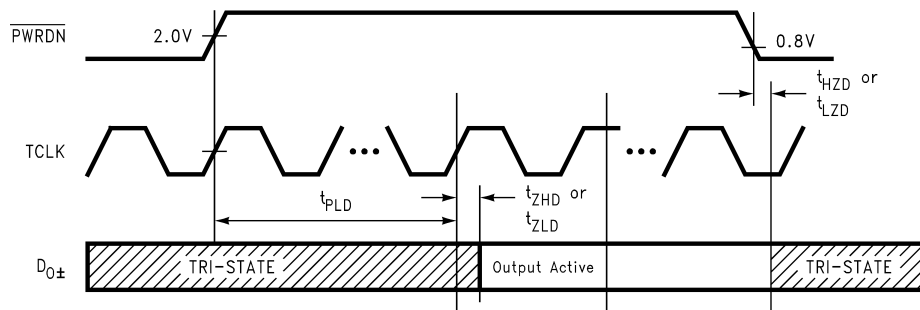
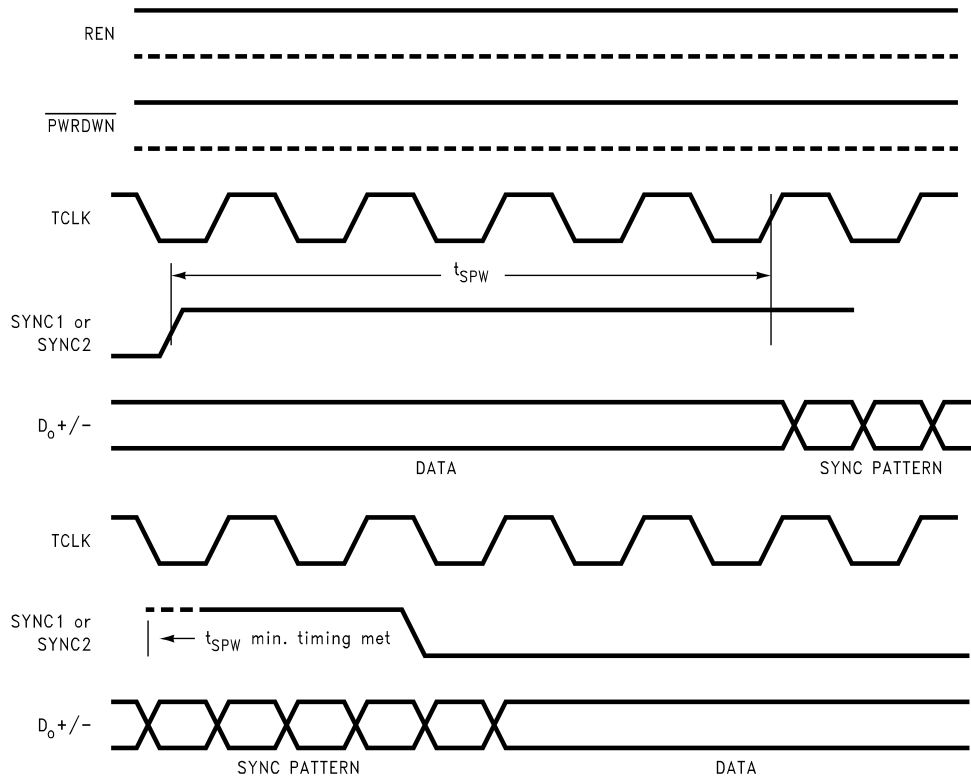
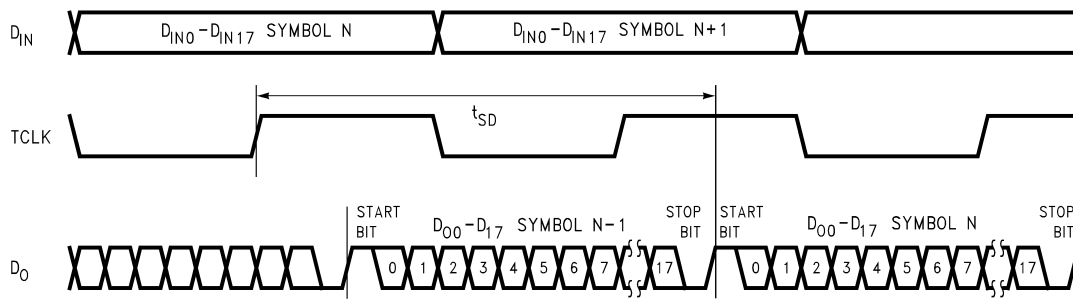

Figure 6. Serializer PLL Lock Time, and  $\overline{\text{PWRDN}}$  TRI-STATE Delays



**Figure 7. SYNC Timing Delay**



**Figure 8. Serializer Delay**



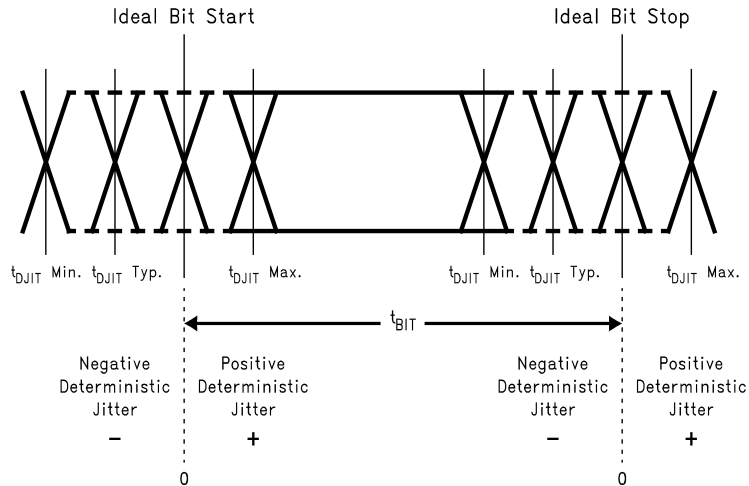
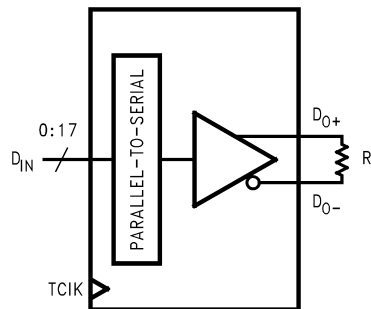

Figure 9. Deterministic Jitter and Ideal Bit Position



$V_{OD} = (D_{0+}) - (D_{0-})$ .  
 Differential output signal is shown as  $(D_{0+}) - (D_{0-})$ , device in Data Transfer mode.

Figure 10.  $V_{OD}$  Diagram

Pre-emphasis Truth Table

PEM LEVEL	PEM2	PEM1	PEM0
0	L	L	L
1	L	L	H
2	L	H	L
3	L	H	H
4	H	L	L
5	H	L	H
6	H	H	L
7	H	H	H

Pin Diagram

Figure 11. SCAN921821TVV  
Top View

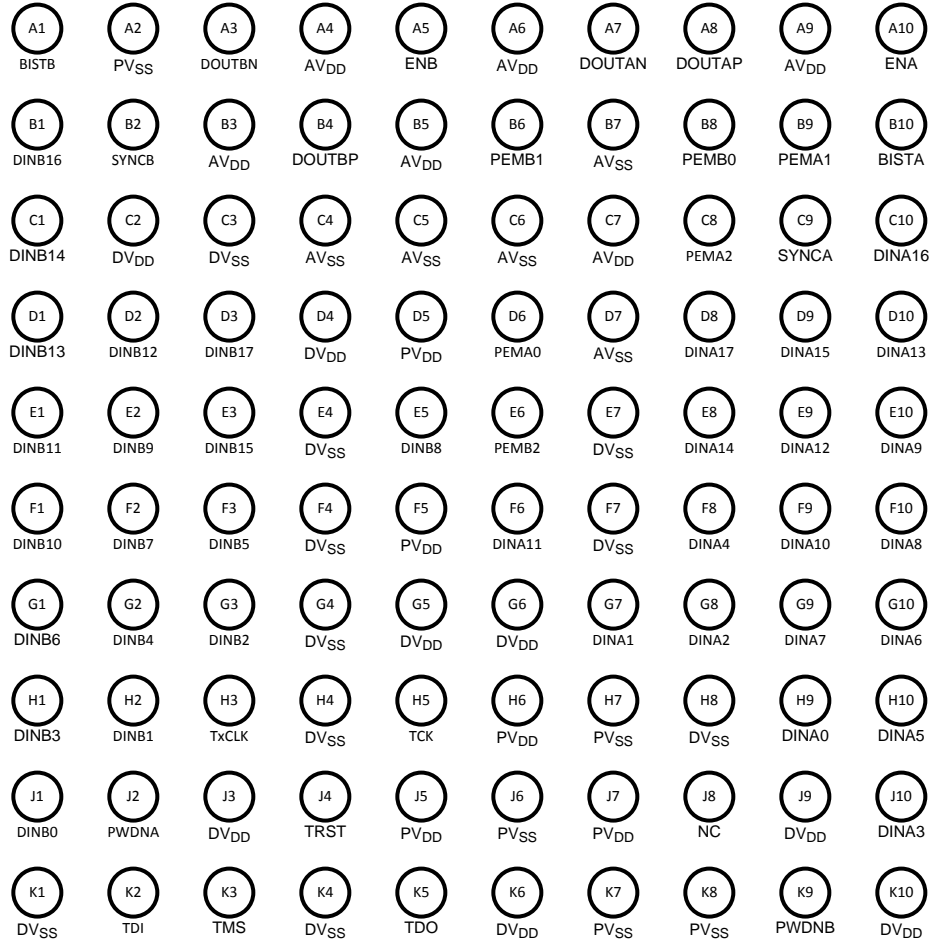

### Pin Descriptions

Pin Name	Pin Count	I/O, Type	Description
<b>DATA PINS</b>			
DINA0-17	18	I, LVCMOS	Transmitter <u>inputs</u> . There is a pull-down circuitry on each of these pins which are active if respective <u>PWDNA</u> or <u>PWDNB</u> pin is pulled high.
DINB0-17	18		
DOUTAP	1	O,BLVDS	Inverting and non-inverting differential transmitter outputs.
DOUTAN	1		
DOUTBP	1		
DOUTAN	1		
<b>TIMING AND CONTROL PINS</b>			
TxCLK	1	I, LVCMOS	Transmitter reference clock. Used to strobe data at the inputs and to drive the transmitter PLL. There is a pull-up circuitry on this pin which is always active.
ENA	1	I, LVCMOS	Transmitter <u>outputs enable pins</u> . There is a pull-down circuitry on each of these pins that are active if corresponding <u>PWDNA</u> or <u>PWDNB</u> pin is pulled high. When these pins are set to LOW, the transmitter outputs will be disabled. The PLL will remain locked.
ENB	1		
<u>PWDNA</u>	1	I, LVCMOS	Stand-by mode pins. There is a pull-down circuitry on each of these pins that are always active. When these pins are set to LOW, the transmitter will be put in low power mode and the PLL will lose lock.
<u>PWDNB</u>	1		
SYNCA	1	I, LVCMOS	Transmitter synchronization pins. There is a pull-down circuitry on each of these pins that are active if corresponding <u>PWDNA</u> or <u>PWDNB</u> pin is pulled high. When these pins are set to HIGH, the transmitter will ignore incoming data and send SYNC patterns to provide a locking reference to receiver(s).
SYNCB	1		
<b>PRE-EMPHASIS PINS</b>			
PEMA0-2	3	I, LVCMOS	8-level pre-emphasis selection pins. There is a pull-down circuitry on each of these pins which are active if corresponding <u>PWDNA</u> or <u>PWDNB</u> pin is pulled high.
PEMB0-2	3		
<b>JTAG PINS</b>			
TDI	1	I, LVCMOS	Test Data Input to support IEEE 1149.1. There is a pull-up circuitry on this pin which is always active.
TDO	1	O, LVCMOS	Test Data Output to support IEEE 1149.1.
TMS	1	I, LVCMOS	Test Mode Select Input to support IEEE 1149.1. There is a pull-up circuitry on this pin which is always active.
TCK	1	I, LVCMOS	Test Clock Input to support IEEE 1149.1. There is no failsafe circuitry on this pin.
<u>TRST</u>	1	I, LVCMOS	Test Reset Input to support IEEE 1149.1. There is a pull-up circuitry on this pin which is always active.
<b>BIST PINS</b>			
BISTA	1	I, LVCMOS	BIST selection pins. These pins select which transmitter will generate a PRBS like data. There is a pull-down circuitry on these pins which are active if corresponding <u>PWDNA</u> or <u>PWDNB</u> pin is pulled high.
BISTB	1		
<b>POWER PINS</b>			
AVDD	6	I, POWER	Power Supply for the LVDS circuitry.
DVDD	8	I, POWER	Power Supply for the digital circuitry.
PVDD	5	I, POWER	Power Supply for the PLL and BG circuitry.
AVSS	5	I, POWER	Ground reference for the LVDS circuitry.
DVSS	10	I, POWER	Ground reference for the digital circuitry.
PVSS	5	I, POWER	Ground reference for the PLL and BG circuitry.
<b>OTHER PINS</b>			
NC	1	N/A	Not connected.

## REVISION HISTORY

Changes from Revision B (April 2013) to Revision C	Page
• Changed layout of National Data Sheet to TI format .....	11

**PACKAGING INFORMATION**

Orderable Device	Status (1)	Package Type	Package Drawing	Pins	Package Qty	Eco Plan (2)	Lead finish/ Ball material (6)	MSL Peak Temp (3)	Op Temp (°C)	Device Marking (4/5)	Samples
SCAN921821TSM/NOPB	ACTIVE	NFBGA	NZD	100	240	RoHS & Green	SNAGCU	Level-4-260C-72 HR	-40 to 85	SCAN921821 TSM	

(1) The marketing status values are defined as follows:

**ACTIVE:** Product device recommended for new designs.

**LIFEBUY:** TI has announced that the device will be discontinued, and a lifetime-buy period is in effect.

**NRND:** Not recommended for new designs. Device is in production to support existing customers, but TI does not recommend using this part in a new design.

**PREVIEW:** Device has been announced but is not in production. Samples may or may not be available.

**OBSOLETE:** TI has discontinued the production of the device.

(2) **RoHS:** TI defines "RoHS" to mean semiconductor products that are compliant with the current EU RoHS requirements for all 10 RoHS substances, including the requirement that RoHS substance do not exceed 0.1% by weight in homogeneous materials. Where designed to be soldered at high temperatures, "RoHS" products are suitable for use in specified lead-free processes. TI may reference these types of products as "Pb-Free".

**RoHS Exempt:** TI defines "RoHS Exempt" to mean products that contain lead but are compliant with EU RoHS pursuant to a specific EU RoHS exemption.

**Green:** TI defines "Green" to mean the content of Chlorine (Cl) and Bromine (Br) based flame retardants meet JS709B low halogen requirements of <=100ppm threshold. Antimony trioxide based flame retardants must also meet the <=1000ppm threshold requirement.

(3) MSL, Peak Temp. - The Moisture Sensitivity Level rating according to the JEDEC industry standard classifications, and peak solder temperature.

(4) There may be additional marking, which relates to the logo, the lot trace code information, or the environmental category on the device.

(5) Multiple Device Markings will be inside parentheses. Only one Device Marking contained in parentheses and separated by a "~" will appear on a device. If a line is indented then it is a continuation of the previous line and the two combined represent the entire Device Marking for that device.

(6) Lead finish/Ball material - Orderable Devices may have multiple material finish options. Finish options are separated by a vertical ruled line. Lead finish/Ball material values may wrap to two lines if the finish value exceeds the maximum column width.

**Important Information and Disclaimer:**The information provided on this page represents TI's knowledge and belief as of the date that it is provided. TI bases its knowledge and belief on information provided by third parties, and makes no representation or warranty as to the accuracy of such information. Efforts are underway to better integrate information from third parties. TI has taken and continues to take reasonable steps to provide representative and accurate information but may not have conducted destructive testing or chemical analysis on incoming materials and chemicals. TI and TI suppliers consider certain information to be proprietary, and thus CAS numbers and other limited information may not be available for release.

In no event shall TI's liability arising out of such information exceed the total purchase price of the TI part(s) at issue in this document sold by TI to Customer on an annual basis.

**TRAY**

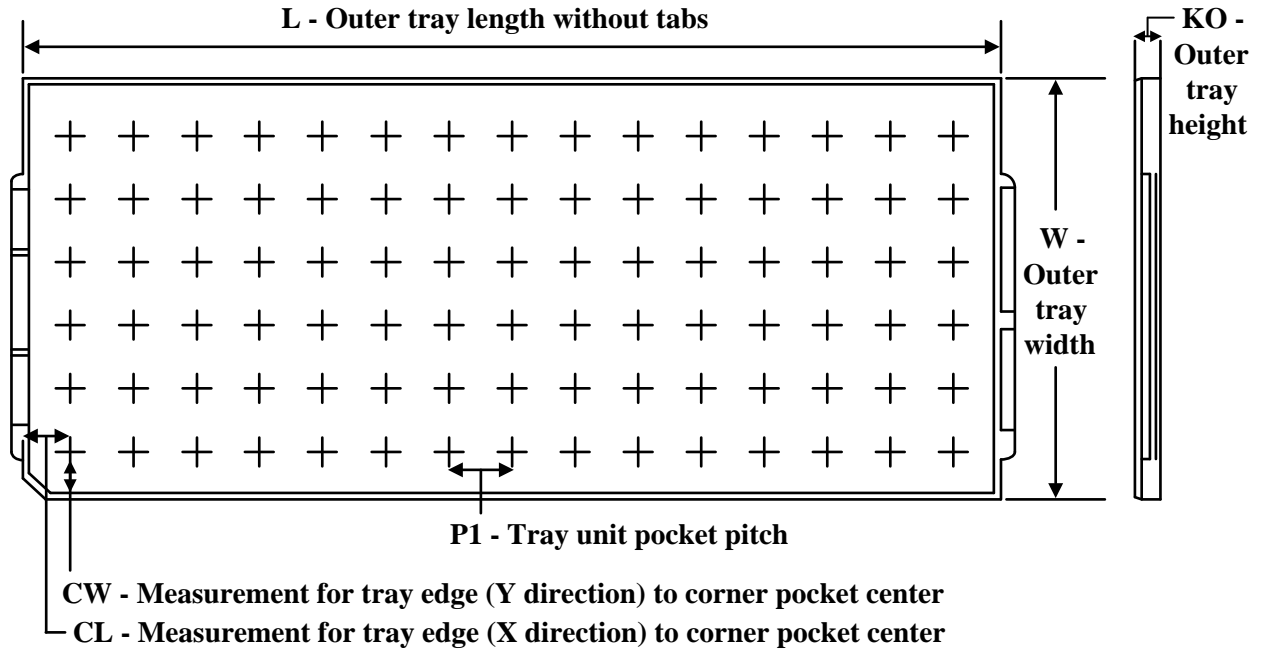

Chamfer on Tray corner indicates Pin 1 orientation of packed units.

\*All dimensions are nominal

Device	Package Name	Package Type	Pins	SPQ	Unit array matrix	Max temperature (°C)	L (mm)	W (mm)	K0 (µm)	P1 (mm)	CL (mm)	CW (mm)
SCAN921821TSM/ NOPB	NZD	NFBGA	100	240	10 X 24	150	322.6	135.9	7620	12.4	14.9	12.15

NZD0100A

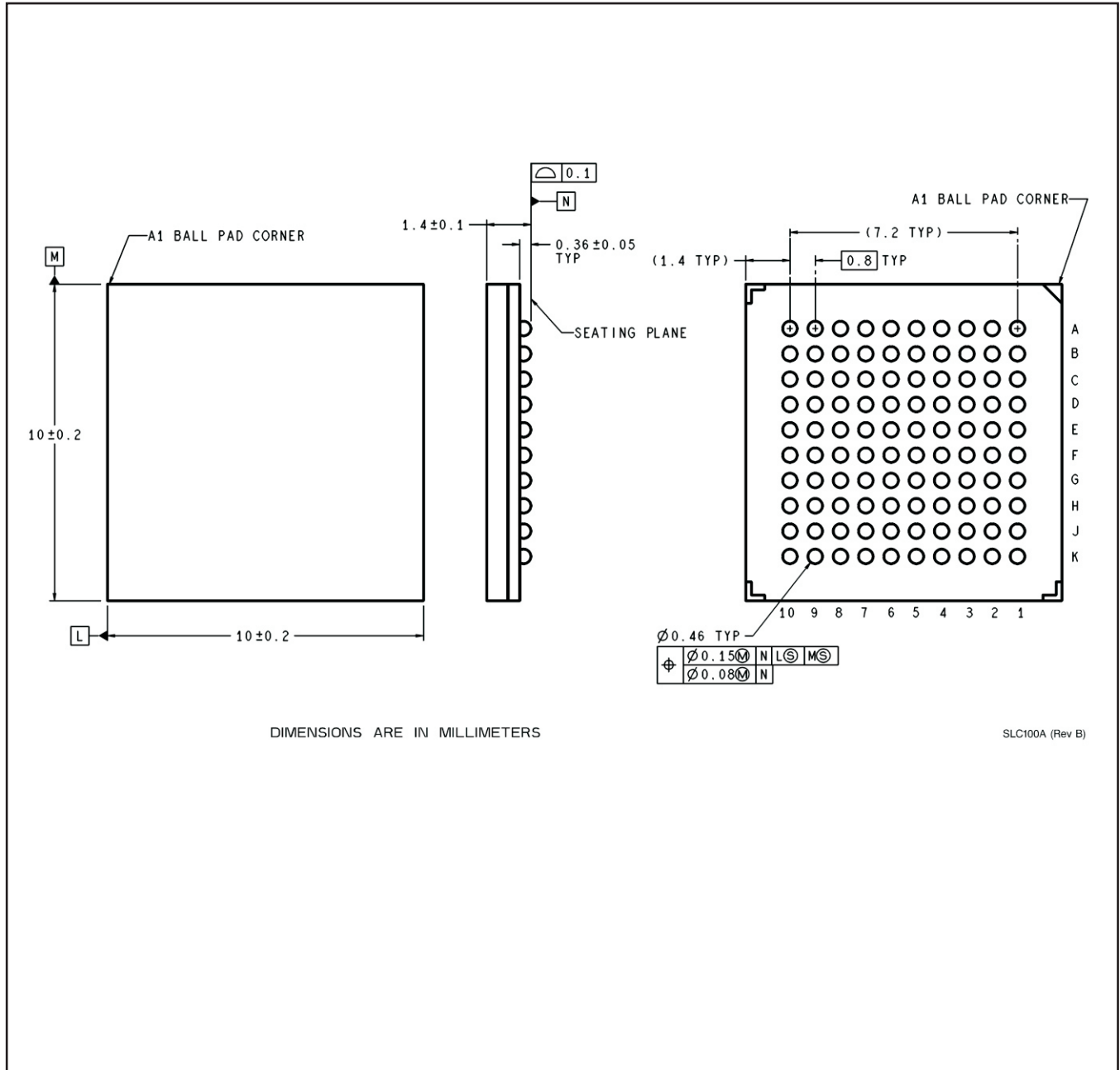

## IMPORTANT NOTICE AND DISCLAIMER

TI PROVIDES TECHNICAL AND RELIABILITY DATA (INCLUDING DATA SHEETS), DESIGN RESOURCES (INCLUDING REFERENCE DESIGNS), APPLICATION OR OTHER DESIGN ADVICE, WEB TOOLS, SAFETY INFORMATION, AND OTHER RESOURCES "AS IS" AND WITH ALL FAULTS, AND DISCLAIMS ALL WARRANTIES, EXPRESS AND IMPLIED, INCLUDING WITHOUT LIMITATION ANY IMPLIED WARRANTIES OF MERCHANTABILITY, FITNESS FOR A PARTICULAR PURPOSE OR NON-INFRINGEMENT OF THIRD PARTY INTELLECTUAL PROPERTY RIGHTS.

These resources are intended for skilled developers designing with TI products. You are solely responsible for (1) selecting the appropriate TI products for your application, (2) designing, validating and testing your application, and (3) ensuring your application meets applicable standards, and any other safety, security, regulatory or other requirements.

These resources are subject to change without notice. TI grants you permission to use these resources only for development of an application that uses the TI products described in the resource. Other reproduction and display of these resources is prohibited. No license is granted to any other TI intellectual property right or to any third party intellectual property right. TI disclaims responsibility for, and you will fully indemnify TI and its representatives against, any claims, damages, costs, losses, and liabilities arising out of your use of these resources.

TI's products are provided subject to [TI's Terms of Sale](#) or other applicable terms available either on [ti.com](https://www.ti.com) or provided in conjunction with such TI products. TI's provision of these resources does not expand or otherwise alter TI's applicable warranties or warranty disclaimers for TI products.

TI objects to and rejects any additional or different terms you may have proposed.

Mailing Address: Texas Instruments, Post Office Box 655303, Dallas, Texas 75265  
Copyright © 2023, Texas Instruments Incorporated