



The Future of Analog IC Technology®

# MP9361

## High Performance Regulated Charge Pump

### DESCRIPTION

The MP9361 is a high performance, regulated charge pump converter. Its input voltage ranges from 2.8V to  $V_{out}$ . The output voltage is regulated to a fixed 5V. No external inductor is required for simplicity and compactness. Internal soft-start circuit effectively reduces the in-rush current both while start-up and mode change.

The MP9361 is available in a compact TSOT23-6 package

### FEATURES

- Input Voltage Range: 2.8V to 5V
- Internal Soft-Start
- Output Maximum Current up to 110mA
- Fixed 5V Output Voltage with 30mV Ripple
- 2X Charge Pump
- Fixed 1.35MHz Switching Frequency
- Over Current Protection
- Short Circuit Protection
- In-rush Current limit
- TSOT23-6 package and Lead (pb)-Free

### APPLICATIONS

- Cell phone, Smart phone, LED backlight
- PDA or hand Held Computer
- Camera Flash White LED
- LCD Display Supply
- TV-Remote Control

"MPS" and "The Future of Analog IC Technology" are Registered Trademarks of Monolithic Power Systems, Inc.

### TYPICAL APPLICATION

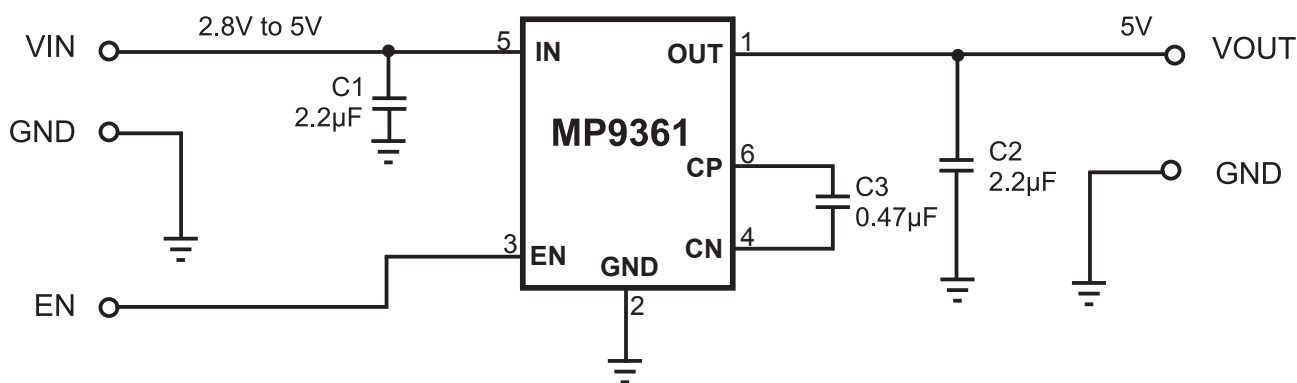

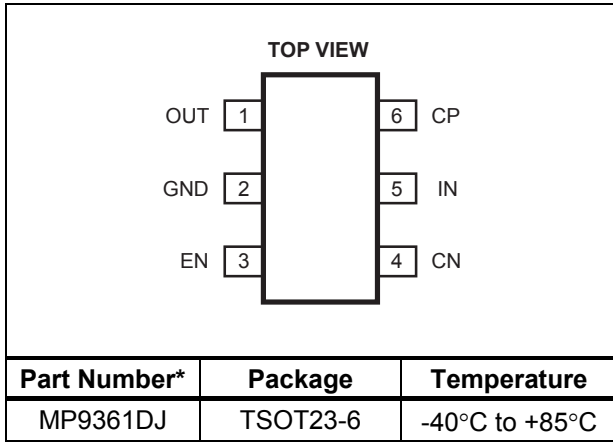
**PACKAGE REFERENCE**

\* For Tape & Reel, add suffix -Z (e.g. MP9361DJ-Z)  
 For RoHS compliant packaging, add suffix -LF  
 (e.g. MP9361DJ-LF-Z)

**ABSOLUTE MAXIMUM RATINGS (1)**

Supply Input Voltage..... -0.3V to +6.0V  
 All Other Pins ..... -0.3V to +6.0V  
 Storage Temperature..... -65°C to +150°C  
 Junction Temperature..... +150°C  
 Lead Temperature ..... +260°C

**Recommended Operating Conditions (2)**

Supply Voltage  $V_{IN}$ ..... 2.8V to 5.0V  
 Output Voltage  $V_{OUT}$ ..... 5.0V  
 Operating Temperature ..... -40°C to +85°C

**Thermal Resistance (3)  $\theta_{JA}$   $\theta_{JC}$** 

TSOT23-6 ..... 195 ..... 25 ... °C/W

**Maximum Power Dissipation (4) ( $T_A=25^\circ\text{C}$ )**

TSOT23-6 .....  $P_D$ ..... 0.64..... W

**Notes:**

- 1) Exceeding these ratings may damage the device.
- 2) The device is not guaranteed to function outside of its operating conditions.
- 3) Measured on JESD51-7 4-layer board.
- 4) Reduce 0.05 watts every 10°C increasing.

**ELECTRICAL CHARACTERISTICS**

$V_{IN}=3.7V$ ,  $C_{IN}=C_{OUT}=2.2\mu F$ ,  $C_P=0.22\mu F$ ,  $T_A=25^\circ\text{C}$ , Unless otherwise noted

Parameter	Symbol	Condition	Min	Typ	Max	Units
Input Supply Voltage	$V_{IN}$		2.8		5	V
Output Voltage	$V_{OUT}$	$V_{IN}>3.2V$ , $I_{OUT}<110mA$	4.8	5	5.2	V
Quiescent Current	$I_Q$	$I_{OUT}=0$		2	4	mA
Maximum Output Current	$I_O$	$V_{IN}>3.2V$	110			mA
Over Current Protection	$I_{OCP}$	$V_{OUT}=5V$	250	350	500	mA
Short Circuit Protection	$I_{SHORT}$			60	90	mA
Output Ripple		$I_{OUT}=60mA$		30		mV
Shut Down Current	$I_{SHDN}$	$V_{IN}=4.5V$ , $V_{EN}<0.4V$		0.1	1	$\mu A$
Operation Frequency	$F_{OSC}$		1.1	1.35	1.6	MHz
Enable Voltage, High	$V_{EN}$ (HIGH)			1.5		V
Enable Voltage, Low	$V_{EN}$ (LOW)			0.4		V
Enable Pin Leakage	$I_{EN}$	$V_{EN}=5V$		0.2	1	$\mu A$

**PIN FUNCTIONS**

Pin #	Name	Description
1	OUT	Output Voltage. Decoupled with a 2.2 $\mu$ F ceramic capacitor for a load current less than 60mA. For a load current greater than 60mA, use 10 $\mu$ F decoupling capacitor.
2	GND	Ground.
3	EN	Device Enable: A logic high input ( $V_{EN}>1.5V$ ) turns on the regulator. A logic low input ( $V_{EN}<0.4V$ )
4	CN	Flying Capacitor Negative Terminal.
5	IN	Input.
6	CP	Flying Capacitor Positive Terminal.

## TYPICAL PERFORMANCE CHARACTERISTICS

$V_{IN}=3.7V$ ,  $V_{OUT}=5V$ ,  $C1=C2=2.2\mu F$ ,  $C3=0.47\mu F$ .  $T_A=25^\circ C$ , unless otherwise noted.

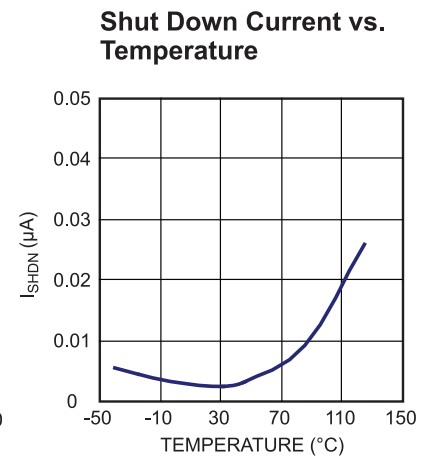
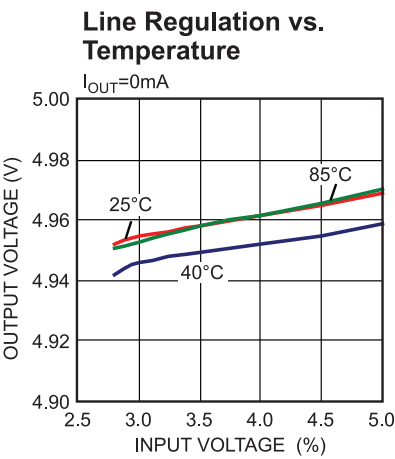
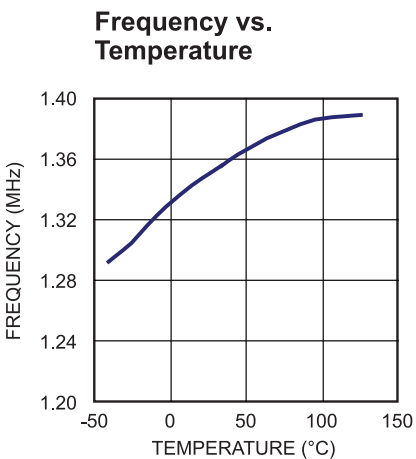
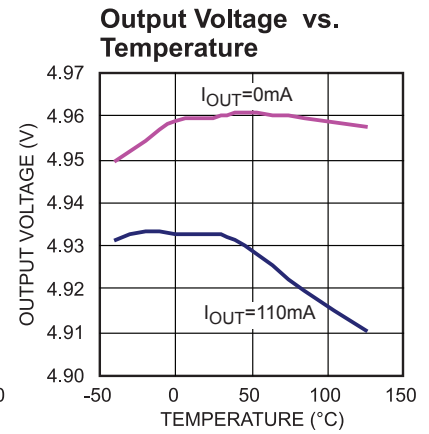
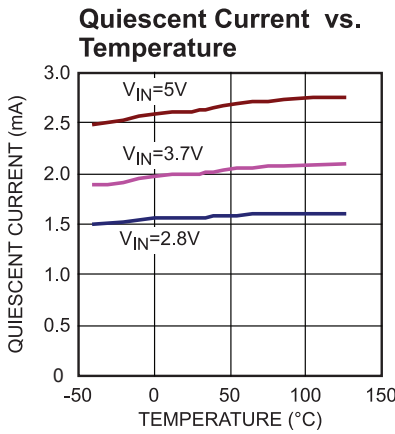
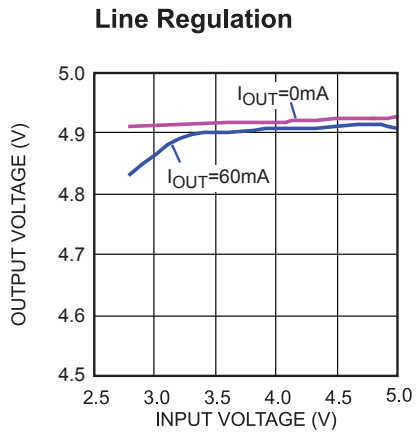
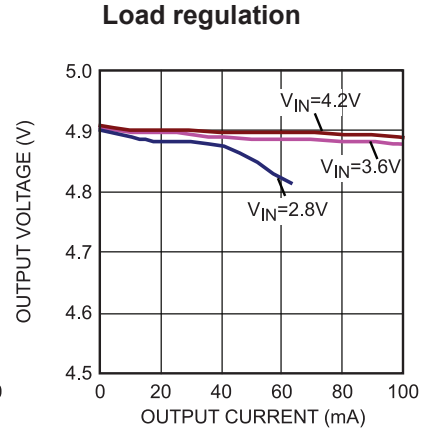
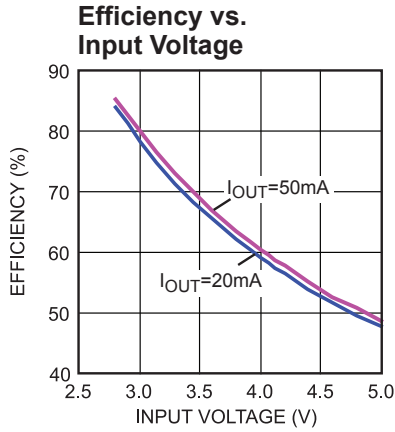
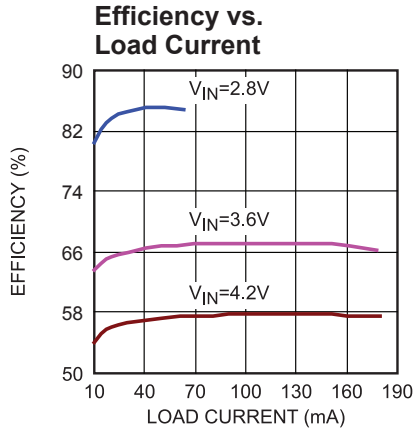

## TYPICAL PERFORMANCE CHARACTERISTICS

$V_{IN}=3.7V$ ,  $V_{OUT}=5V$ ,  $C1=C2=2.2\mu F$ ,  $C3=0.47\mu F$ .  $T_A=25^\circ C$  Unless otherwise noted. (continued)

### Inrush Current

$V_{IN}=2.8V$ ,  $I_{OUT}=64mA$   
with resistor load

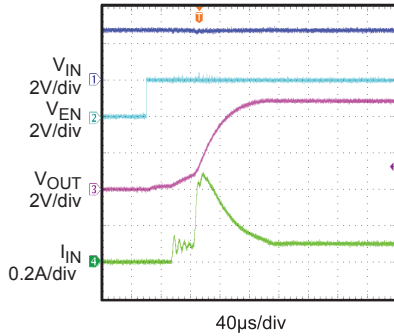

### Inrush Current

$V_{GN}=V_{IN}=3.6V$ ,  $I_{OUT}=64mA$   
with resistor load

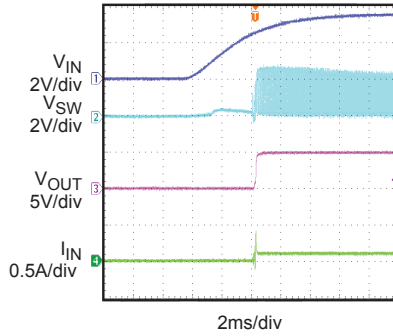

### Load PWM Dimming Operation

$V_{EN}=V_{IN}=2.8V$ ,  $F_{PWM}=100HZ$

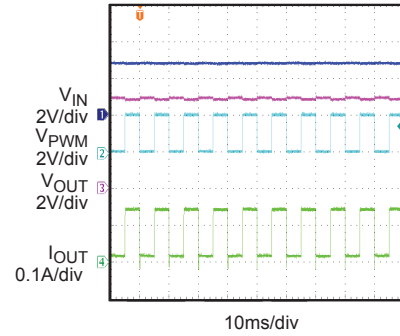

### Load PWM Dimming Operation

$V_{EN}=V_{IN}=2.8V$ ,  $F_{PWM}=2KHZ$

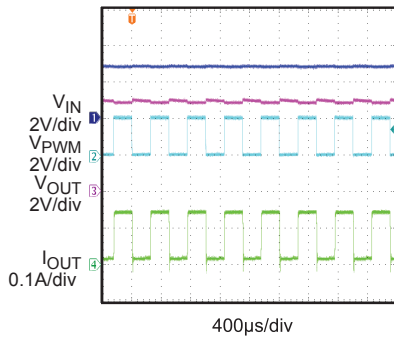

### Normal Load Ripple

$V_{EN}=V_{IN}=2.8V$ ,  $V_{OUT}=5V$ ,  $I_{OUT}=60mA$

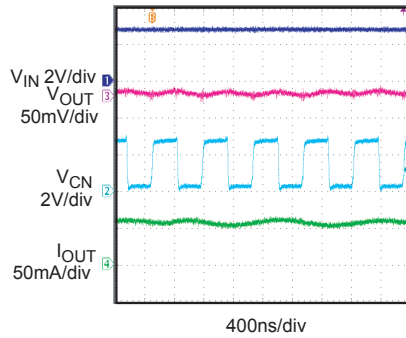

### Normal Load Ripple

$V_{IN}=V_{EN}=4V$ ,  $I_{OUT}=60mA$

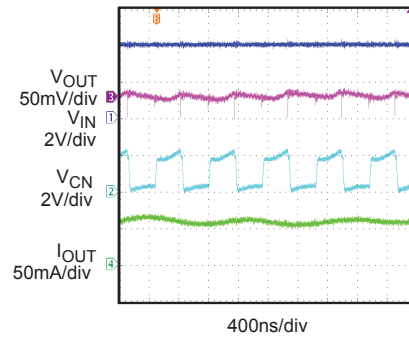

## OPERATION

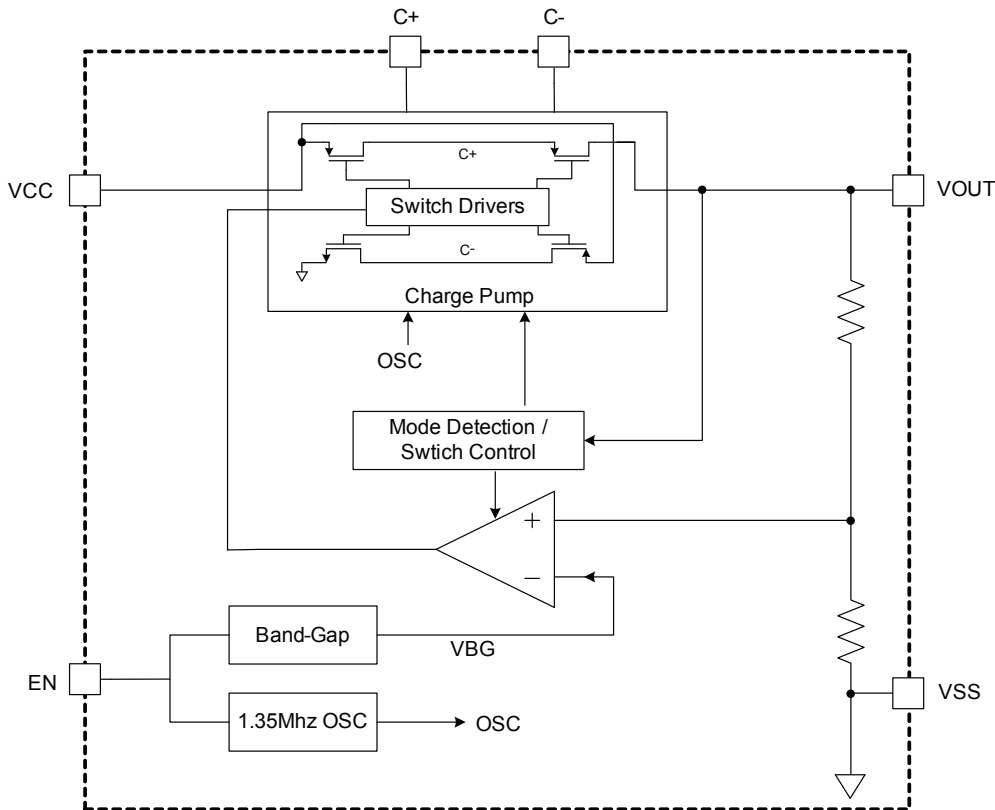

**Figure 1— Functional Block Diagram**

The MP9361 uses a switched capacitor charge pump to boost an input voltage to a regulated output voltage. Regulation is achieved by sensing the charge pump output voltage through an internal resistor divider network. A switched doubling circuit is enabled when the divided output drops below a preset trip point controlled by an internal comparator.

The switching signal, which drives the charge pump, is created by an integrated oscillator within the control circuit block. The fixed charge pump switching frequency is approximately 1.35MHz.

The MP9361 has complete output short-circuit and thermal protection to safeguard the device under extreme operating conditions. An internal thermal protection circuit senses die temperature and will shut down the device if the internal junction temperature exceeds approximately 145°C. The charge pump will remain disabled until the fault condition is relieved.

PACKAGE INFORMATION

TSOT23-6

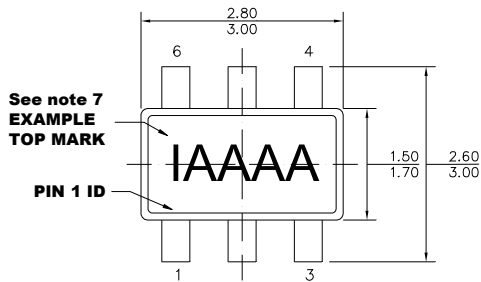

**TOP VIEW**

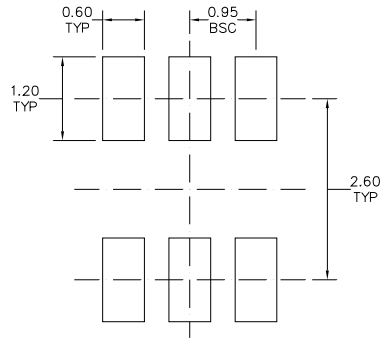

**RECOMMENDED LAND PATTERN**

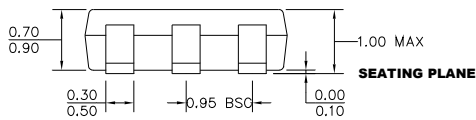

**FRONT VIEW**

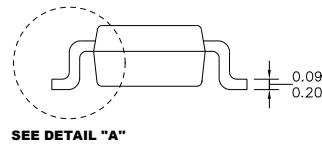

**SIDE VIEW**

**NOTE:**

- 1) ALL DIMENSIONS ARE IN MILLIMETERS.
- 2) PACKAGE LENGTH DOES NOT INCLUDE MOLD FLASH, PROTRUSION OR GATE BURR.
- 3) PACKAGE WIDTH DOES NOT INCLUDE INTERLEAD FLASH OR PROTRUSION.
- 4) LEAD COPLANARITY (BOTTOM OF LEADS AFTER FORMING) SHALL BE 0.10 MILLIMETERS MAX.
- 5) DRAWING CONFORMS TO JEDEC MO-193, VARIATION AB.
- 6) DRAWING IS NOT TO SCALE.
- 7) PIN 1 IS LOWER LEFT PIN WHEN READING TOP MARK FROM LEFT TO RIGHT, (SEE EXAMPLE TOP MARK)

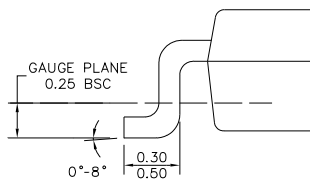

**DETAIL "A"**

**REVISION HISTORY**

<b>Revision #</b>	<b>Revision Date</b>	<b>Description</b>	<b>Pages Updated</b>
1.0	4/7/2021	Correct the description about EN logic.	Page 3

**NOTICE:** The information in this document is subject to change without notice. Users should warrant and guarantee that third party Intellectual Property rights are not infringed upon when integrating MPS products into any application. MPS will not assume any legal responsibility for any said applications.